

Smappee Infinity Installation manual

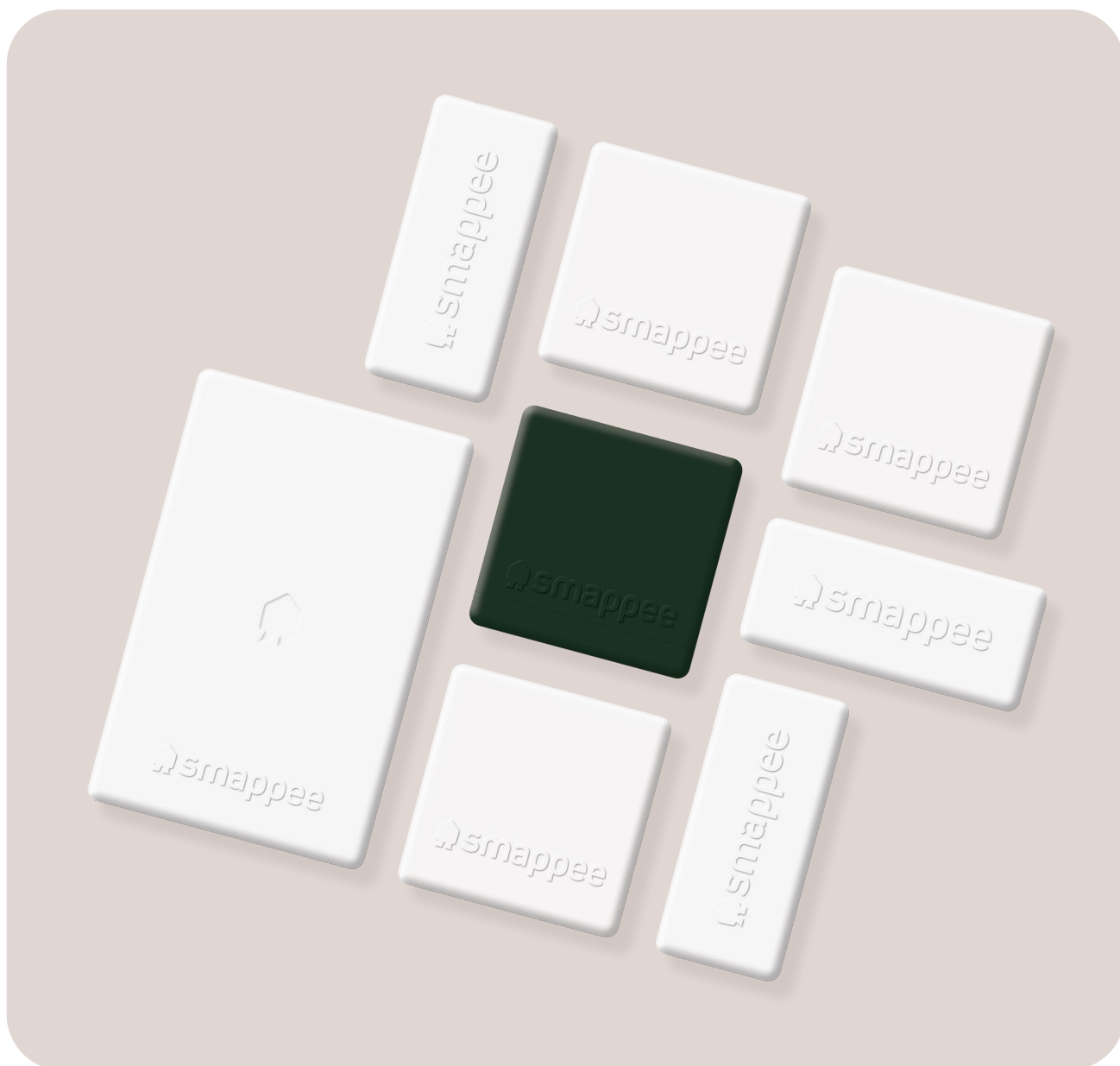

Document accuracy

The specifications and other information in this document were verified to be accurate and complete at the time of its publication. Due to ongoing product improvement, this information is subject to change at any time without prior notice. For the latest information, see our online documentation: smappee.com/downloads

Table of contents

1. Introduction.....	4
2. Safety instructions.....	5
3. Smappee Infinity	8
4. Prepare the installation	10
5. Installation and configuration	11
6. Validation of the Smappee Infinity installation	20
7. Add an Input module	21
8. Add an Output module	24
9. Replace a Connect by a Genius	28
10. Troubleshooting	29
Annexes	37

1. Introduction

Thank you for purchasing Smappee Infinity.

This installation manual tells you how to install Smappee Infinity. We recommend that you read the contents of this manual carefully, to ensure a safe and proper installation and enable to use all the advanced features of this product to the full.

Support

Only qualified electricians or equivalent may install Smappee Infinity. If you have any questions, please contact your service partner.

Please have the following information ready to hand to speed up the process: Article number and serial number which you can find on the identification label of the gateway.



Should your local distributor be unable to help you, or you have a suggestion for us, you can contact Smappee at: **support@smappee.com**.

Smappee NV
Evolis 104
8530 Harelbeke
Belgium

2. Safety instructions



2.1. Safety warning

Carrying out electrical work in a home or workplace can be dangerous.

The Power Box, CT Hub, Solid Core 3-Phase CT, Current Transformers (CT) and Rogowski coils are usually installed inside the distribution board under a protective cover. The other components can be installed both inside and outside the distribution board.

Only certified electricians may carry out the installation, which must be in accordance with the national safety regulations.

2.2. Safety precautions

	<p>CAUTION Risk of electric shock.</p>
	<p>CAUTION Risk of electric shock. Refer to the accompanying documentation whenever you see this symbol.</p>
	<p>CAUTION Risk of electric shock, burns, or arc flash. Do not clamp or pull out non-insulated conductors carrying dangerous voltage</p>

Please observe the following safety precautions to avoid potential electric shock, fire, or personal injury:

- Use this product only for its intended purpose.
- Use the product indoors only.
- Only mount the power supply cable in a sealed enclosure.
- Locate a free circuit breaker or install an additional circuit breaker for the connection of the Power Box. Connect the power supply cable according to the applicable connection diagram, refer to Connection diagrams (page 37). The circuit breaker acts as the disconnect device and must meet IEC 60947-2.
- Do not open the equipment or touch any of its electronic circuitry.
- Do not attempt to open, repair, or service any parts.
- Only use the power supply cable delivered with the product.
- Do not install or use the product if damaged.
- Do not install or use damaged current transformers or cables.
- Do not immerse the product in water or any other liquids.
- Do not expose the product to heat, flame, or extreme cold.

2.3. Specifications

Feature	Description
Storage temperature	-20 °C to 90 °C
Operating temperature	-10 °C to 50 °C
Relative humidity	0 % - 95 %, non-condensing
Maximum installation altitude	0 – 2.000 m
Power consumption	8 W
Power supply input	90 to 264 VAC
Frequency	50/60 Hz
IP rating (IEC 60529)	IP X0
Impact rating (IEC 62262)	IK 08
Safety	IEC 61010-1
EMC	IEC 61356-1, FCC 47 part 15



2.4. Maintenance

- Clean the outside only with a dry, clean cloth.
- Do not use abrasive agents or solvents.
- Replace worn or damaged parts.

2.5. Responsibility

- Assembly, connection, and use must be carried out in accordance with the installation standards currently in force.
- The device must be installed in accordance with the instructions given in this manual.
- Failure to observe the instructions for installing this unit may compromise the device's intrinsic protection.
- The device must be placed in a system that complies with the applicable standards and safety regulations of the country of installation.
- Cables may only be replaced with cables of the correct rating.

2.6. Explanation of the safety symbols

Symbol	Description
	Class II equipment: double insulated, does not require an earth connection
 IK 08	This device has been tested according to IEC 62262 and complies to impact class 8

2.7. Residual safety risk

When there is visible damage to the device's housing, it is recommended to replace the device to prevent any hazardous situation to occur.

ID	Description	More information
1	Split Core CTs	This is a current transformer which the solid core can be split so that it can be put around the wire without disconnecting it. These transformers are available in different ampere ratings to suit the specific circuit to be monitored. The measured current value is transmitted to a CT Hub for further processing.
2	Rogowski coil	This is a current transformer which flexible core can be split so that it can be put around the wire without disconnecting it. These transformers are available in different ampere ratings to suit the specific circuit to be monitored. The measured current value is transmitted to a CT Hub for further processing.
3	Solid Core 3-Phase CT	This is a current transformer with a solid body to put three wires through near a 3-Phase circuit breaker. The three measured value are sent to the Power Box.
4	CT Hub	Transfers data from Split Core CTs and Rogowski coils to the Power Box.
5	Power Box	The Power Box supplies power to the Smappee modules. The Power Box measures the voltage of each connected phase and processes voltage and current data and transmits this information via a gateway to the Smappee Cloud for further processing.
6	Input module	Module to add maximum four inputs to control the Smappee Infinity functionalities.
7	Output module	Module to control maximum two appliances with Smappee Infinity.
8	Genius	Gateway with the most functionality.
9	Connect	Gateway with the basic functionality. There are different variants in Smappee Connect-series.
A	A-bus	High speed data bus that transmits CT-data to the Power Box.
B	B-bus	Data bus that transmits data to the Gateway.
C	Gateways	A gateway has a wired or wireless internet connection with the Smappee Cloud. In a multi-gateway setup, there can be only one Smappee Genius, for local data aggregation, and one or more Smappee Connect modules.
D	Power supply cable	Supplies power from a circuit breaker to the Power Box.
E	Bus termination plug	Closes the A-bus.
F	Network cable	For wired connection of the gateway to the internet. Power over Ethernet (PoE) is not supported by the gateways.
G	Smappee Switch	Monitors and controls the power supply to the connected application.
-	Smappee App	The mobile application to configure and use your energy management solution. It can be downloaded from the Apple App store or Google Play to use Smappee Infinity.
-	Smappee Dashboard	The web application on dashboard.smappee.net for advanced use of different Smappee Infinity installations.

4. Prepare the installation

Thanks to the compact hardware, Smappee Infinity fits easily into almost any distribution panel. Once the system is up and running, maintenance requires little effort, resulting in a low total cost of ownership.

Prepare the following items at your premises to save valuable time on-site.

1. Smappee Configurator
2. Supplies (not included)
3. Tools (not included)

4.1. Smappee Configurator

On dashboard.smappee.net/configurator you can access our four-step Smappee Configurator, which guides you to find the modules for the new Smappee Infinity installation. The bill of materials has the article numbers, article description and necessary quantities to be ordered at Smappee.

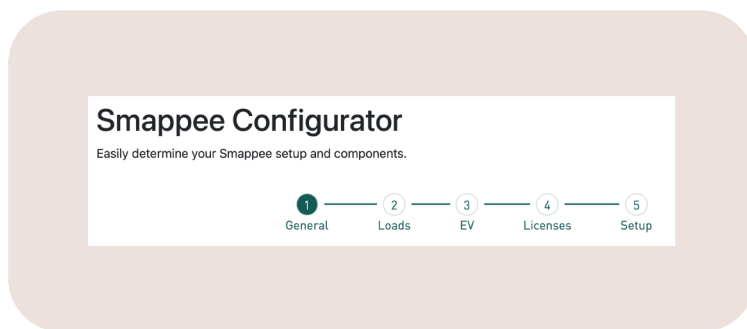

Image 2: Screenshot of the Smappee Configurator

You can always order more components, refer to Smappee Infinity components (page 44).

4.2. Supplies (not included)

- Circuit breaker for Power Box only
2P, 3P, 4P according to the applicable connection diagram (page 37)
- For Genius: external Wi-Fi antenna in the case of low Wi-Fi signal
- Network cable and RJ45 connectors, minimum Cat5 depending on the environment, if using wired internet connection
- 4G router, refer to Mount the gateway (page 17)
- Solid wire with section of 0.5 to 1.5 mm² (20 AWG to 15 AWG) when installing an Input module and/or Output module.
- Cable ties

4.3. Tools (not included)

- Flashlight
- Multimeter
- Screwdrivers
- Wire cutter
- Wire stripper
- Needle-nose pliers
- Drill, drill bits and screws

5. Installation and configuration



CAUTION

Risk of electric shock.

For safety purposes, it is necessary to stop the power supply before proceeding with the physical installation.

To save valuable time on-site, refer to Prepare the installation (page 10). Once you have all necessary components, do the following to add Smappee Infinity to your electrical installation:

1. Install the circuit breaker for Smappee Infinity (page 12)
2. Mount the Power Box (page 13)
3. Install the current transformers (page 13)
4. Install the CT Hubs (page 16)
5. Mount the gateway (page 17)
6. Configure Smappee Infinity (page 18)

Once the installation is complete, it is good practice to validate the correct operation of the monitoring solution. For more information, refer to Validation of the Smappee Infinity installation (page 20).



NOTE

To monitor and control appliances with Smappee Infinity, you can:

- Add an Input module (page 21)
- Add an Output module (page 24)

5.1. Install the circuit breaker for Smappee Infinity

Context

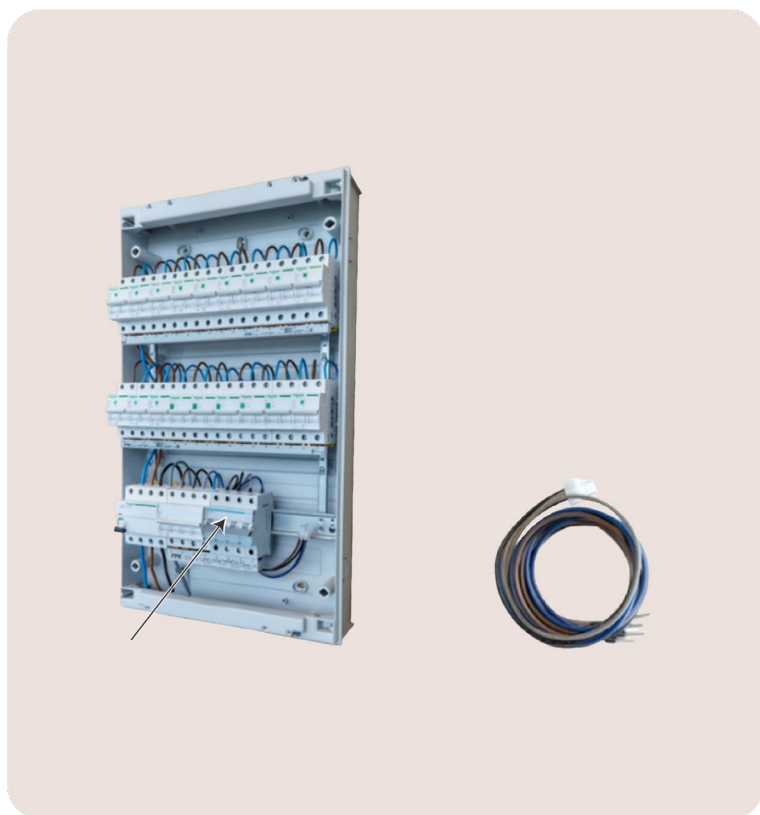

Image 3: View on a distribution panel and the power supply cable

Instructions

Proceed as follows.

1. Locate a free circuit breaker or install an additional circuit breaker for the connection of the Power Box.
2. Connect the power supply cable according to the applicable connection diagram.

NOTE

Each wire of the power supply is monitored and used for calibration of Smappee Infinity.

All live conductors should be connected according to the applicable connection diagram (page 37):



- Connection diagram – 1 x 230 V (page 37)
- Connection diagram – 3 x 400 V + N (page 38)
- Connection diagram – 3 x 230 V (page 39)
- Connection diagram – 2 x 120/240 V (page 40)
- Connection diagram – 3 x 120/208 V or 3 x 277/480 V (page 41)
- Connection diagram – 3 x 347/600 V (page 42)

5.2. Mount the Power Box

Context



Image 4: View on a distribution panel with DIN mounting plate and Power Box





Instructions

Proceed as follows.

1. Attach the DIN mounting plate to the DIN rail.
The plate clips over the rail. The magnet let you easily remove the Power Box during installation.
2. Connect the power supply cable from the circuit breaker to the Power Box.
3. Attach the Power Box to the DIN mounting plate.

5.3. Install the current transformers

Context

	<p>NOTE</p> <p>For a Split Core CT and a Rogowski coil it is not necessary to disconnect the wires from the circuit breakers. The body of the current transformer can be opened to put it around the wire.</p>
	<p>NOTE</p> <p>For a Solid Core 3-Phase CT it is necessary to disconnect the wires. Use a logical order, for example: terminal 1 = L1, terminal 2 = L2, terminal 3 = L3.</p>
	<p>NOTE</p> <p>The arrow on each current transformer indicates the direction of the energy flow towards the load (L).</p>
	<p>For future ease of service, attach a label with the CT Hub number to both ends of the wire.</p>

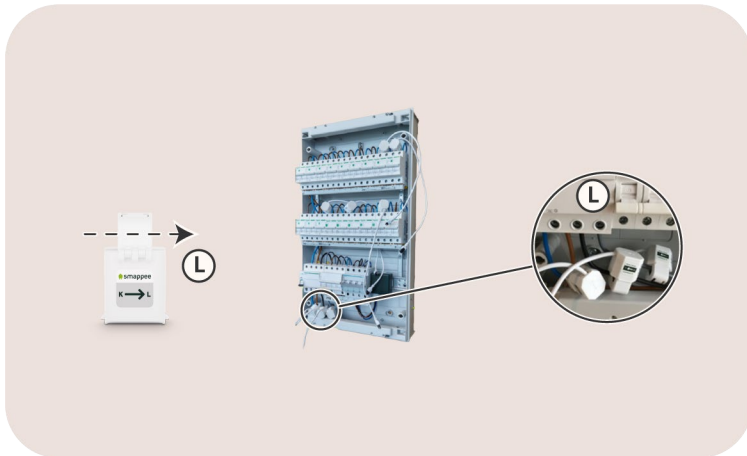

Image 5: View on the arrow on a current transformer and its installation in the distribution panel

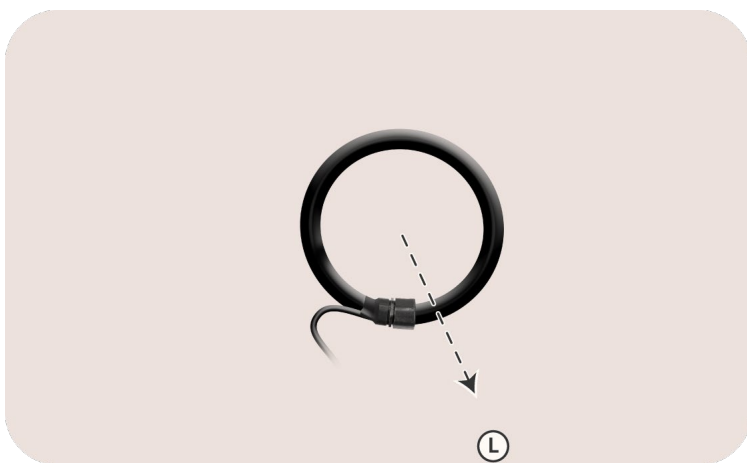

Image 6: View on the arrow on a Rogowski coil

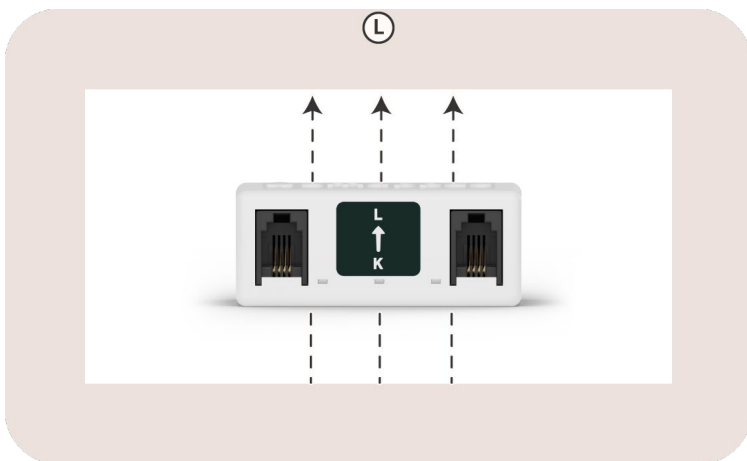



Image 7: View on the arrow on a Solid Core CT

Instructions

Proceed as follows

1. Attach the current transformer for monitoring the power supply from the grid to the installation (L).

	<p>NOTE</p> <p>For more information, refer to the applicable connection diagram (page 37):</p> <ul style="list-style-type: none">• Connection diagram – 1 x 230 V (page 37)• Connection diagram – 3 x 400 V + N (page 38)• Connection diagram – 3 x 230 V (page 39)• Connection diagram – 2 x 120/240 V (page 40)• Connection diagram – 3 x 120/208 V or 3 x 277/480 V (page 41)• Connection diagram – 3 x 347/600 V (page 42)
---	--

2. Attach the current transformer for monitoring the current flow from a production source to the installation (L).
For example, the solar power at your location.

	<p>NOTE</p> <ul style="list-style-type: none">• Measuring solar power generation, where applicable, is recommended. This gives insights in the energy flows.• If you have a battery, it is highly recommended to also measure the energy flow from the battery towards the load (L). For example the value for always on usage should consider the power supplied by the battery.
---	---

3. Attach the current transformers for each load (L) to be monitored.
For example, the heatpump at your location.

5.4. Install the CT Hubs

Context

A CT Hub (4) transfers data from Split Core CTs (1) and Rogowski coils (2) to the Power Box (5).

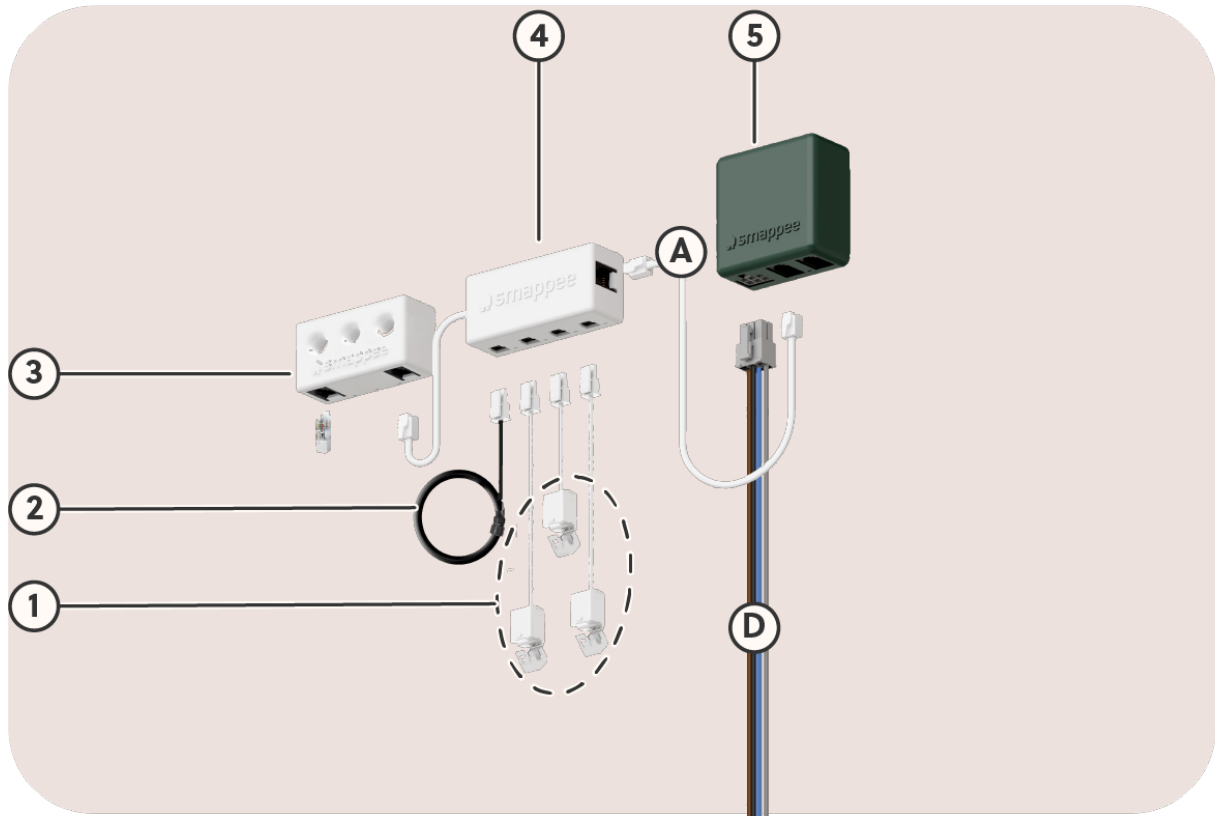



Image 8: Schematic view of the Smappee A-bus circuit

Instructions

Proceed as follows.

1. Connect the Split Core CTs and the Rogowski coil to a CT Hub.
Use a logical order, for example: terminal 1 = L1, terminal 2 = L2, terminal 3 = L3.
For more information, refer to Connection diagrams (page 37).

 The Solid Core 3-Phase CT (3) needs to be in the Smappee A-bus circuit, refer to the next steps.

2. Remove the bus termination plug from the A-terminal of the Power Box.
3. Make with the Smappee Bus cables a circuit from the A-terminal of the Power Box, through the CT Hubs and Solid Core 3-Phase CTs, until the bus terminator plug in the last CT Hub or Solid Core 3-Phase CT.
4. Attach the CT Hubs with cable ties to the fixed parts of the distribution panel.

5.5. Mount the gateway

Context

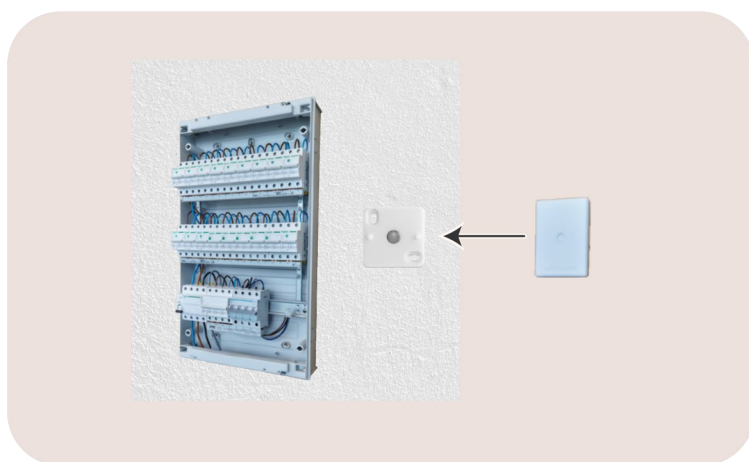

Image 9: View on a distribution panel and gateway connected to a wall mounting plate

Instructions

Proceed as follows.

1. Attach the wall mounting plate adjacent to the distribution panel.
If the gateway on a DIN mounting plate behind a protective cover, there can be a weak Wi-Fi-signal.
2. Attach the gateway to the wall mounting plate.
The gateway can be a Snappee Genius or from the Snappee Connect-series.
The magnet on the gateway let you easily disconnect it, so you can read the markers while connecting cables.
3. Connect the Snappee Bus cable from the B-terminal of the Power Box to the gateway.
For more information, refer to Snappee Bus (page 45).
4. Connect the network cable to the gateway, if necessary at your location.
The gateways have the following possible internet connectivity.

Internet connectivity	Gateway			
	Genius	Connect	Wi-Fi Connect	4G Connect
Wired ethernet (100BASE-T)	yes	yes	no	no
Wi-Fi 2.4 GHz	yes	yes	yes	no
LTE CAT M1 worldwide band support	(*)	(*)	no	yes

(*) 3G / 4G is possible with a Teltonika RUT240 4G Router.

5.6. Configure Smappee Infinity

Prerequisites

This procedure is done with the Smappee App. You can download this mobile app from the Apple App Store for iOS or the Google Play store for Android phones.



Image 10: Download the Smappee App

Context

	<p>WARNING</p> <p>For functional purposes, it is necessary to start the power supply during the configuration. Think about the safety of you and others.</p>
--	---

Instructions

1. Open the Smappee App.
Login to the Smappee App with your partner user account.
2. Tap the **House** button.
3. Tap the **+** button.
4. Tap the **I want to install a Smappee monitor** button.

	<p>NOTE</p> <p>For the addition of Smappee Infinity to an existing Smappee location, go to Settings > Install a Smappee monitor.</p>
--	---

5. Follow the steps shown in the Smappee App.
The Smappee App guides you through the necessary steps to configure Smappee Infinity. For example, the Smappee App reminds you to stop the mobile internet connection of your mobile device when you transfer data from your mobile device to the gateway.

	<p>NOTE</p> <p>It is recommended to measure the power supply from the grid. For a 3 x 230 V without neutral conductor, there are some specific items. For more information, refer to Connection diagrams (page 37).</p>
--	--

6. Start the power supply to Smappee Infinity when asked for the colour shown. The internet connection of the gateway is made.
- A Genius will automatically check which internet connectivity is used. For more information, refer to internet connectivity (page 17).
 - For a gateway from the Connect-series, you need to indicate in the Smappee App which internet connection you want to use.

If the Wi-Fi is used, the gateway shows after maximum 10 minutes a flashing blue colour. Select on your mobile device the hotspot of the gateway in the list of available WiFi-networks. For more information, refer to Wi-Fi connection properties and firewall rules (page 47).

As a result, the Smappee App shows a confirmation screen.



NOTE

For more information, refer to the [Smappee Academy](#).

6. Validation of the Smappee Infinity installation

The colour code inside the distribution panel and/or phase numbering may be incorrect. You should check that all current transformers are operational and measuring the correct power values. If loads are being measured, this does not automatically mean that the power values are correct. Incorrect phase mapping or incorrect direction of a current transformer could lead to incorrect power values and wrong monitoring data.

Use a digital multimeter to find which phase powers the connected load.

1. Measure the voltage between a phase of the grid measurement and the related phase of the power supply cable to the Power Box.
This should be the same phase and thus a measurement 0 V.
Measure between the connection point of the live conductor where the current transformer is and the phase 1 at the Power Box. If you measure another value, find the related phase at the Power Box. Repeat this for each phase until you know how to change the physical connection of each live conductors, so that phase 1 in Smappee Infinity is phase 1 of the grid.
2. Measure the voltage between a phase wire to a load and the related phase of the grid measurement.
This should also result in 0 V.
For loads which have a multiphase connection make sure the other phases are also correctly connected and measured.
3. Repeat this for each load.
There can be specific energy flows to measure. For example, from energy generation to the electrical installation, from the battery storage to the electrical installation.

To check the correct operation of Smappee Infinity, Smappee provides real-time values of all measured loads by the following topics:

- Real-time values in the Smappee App
- Real-time values in the Smappee Dashboard

If necessary, adjust the configuration of this Smappee location in the Smappee Cloud via the Smappee App or the Smappee Dashboard.

6.1. Real-time values in the Smappee App

The Smappee App reports real-time active power values for each input individually.

1. Go to **Settings > Smappee monitors > Load configuration**.
2. Tap a specific load to review and set the details of this load.
This can be the used input of the CT Hub, the phase mapping properties, ...

6.2. Real-time values in the Smappee Dashboard

The Smappee Dashboard reports real-time the active and reactive power, line & phase voltage, power factor, and current of each input.

1. Go to dashboard.smappee.net.
2. Open the **Load configuration** card to review and set the configuration.

7. Add an Input module

The Input module has 4 digital inputs:

- To count pulses, or
- To monitor input status (low/high)

The inputs are indicated on the bottom of the module. An input has two horizontal wire connections next to each other.

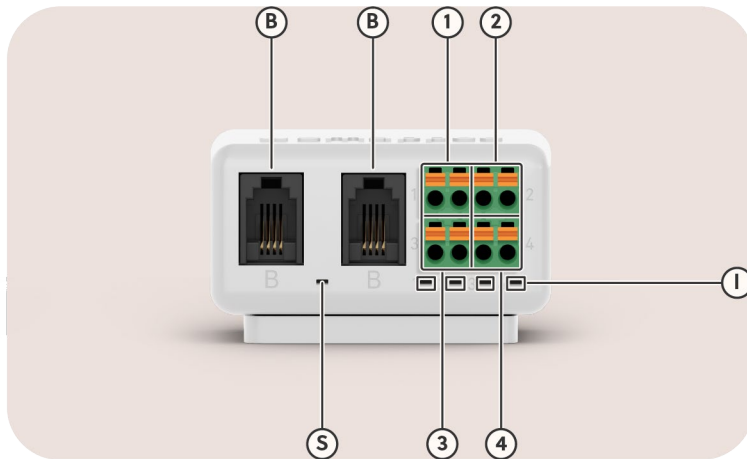

Image 11: View on an Input module

ID	Description	More information
1	Input 1	Each input has 2 terminals.
2	Input 2	
3	Input 3	
4	Input 4	
I	Input LED	Status of the input
B	B-port	2 terminals to daisy chain the modules in the B-bus
S	Status LED	Status of the internet connection



NOTE

An Input module is compatible only with a Smappee Genius as gateway. If your Smappee Infinity has a Smappee Connect, you need to replace it with a Smappee Genius. For more information, refer to page 28.

Proceed as follows.

1. Install an Input module (page 22)
2. Configure an Input module (page 23)

7.1. Install an Input module

Context

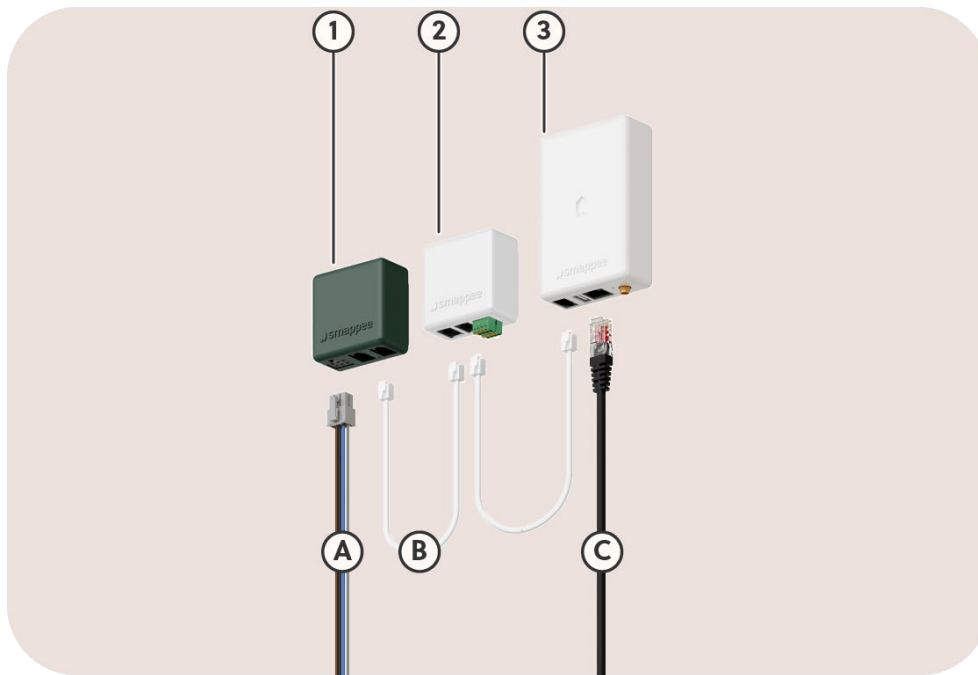



Image 12: Schematic view of the Smappee B-bus circuit

ID	Description
1	Power Box
2	Input module
3	Genius
A	Power supply cable
B	B-bus
C	Network cable

For more information, refer to page 8.

Instructions

1. Make sure Smappee Infinity is installed and operational.
For more information, refer to Installation and configuration (page 11).
2. Make B-bus circuit with the Smappee Bus cables from the Power Box, through the Input module, until the Genius.

	<p>NOTE</p> <p>Both B-terminals are identical. There is no special attention to the order of Input modules and Output modules necessary to make the circuit. For more information, refer to Smappee Bus (page 45).</p> <p>The maximum number of Input modules and Output modules per Genius is 10.</p>
---	---

3. Connect a trigger to the Input module.
For more information, refer to the following topic.

Connect a trigger to the Input module

1. Strip the two solid wires for 5 mm.
 - Use a solid wire with a diameter range 0.5 to 1.5 mm² (20 AWG to 15 AWG). Stranded cable is not recommended, because you need correct cable lugs.
 - For future ease of service, attach a label with the input number to both ends of the cable.
2. Pull the green connector away from the module to disconnect it from the module.
3. Push and hold the orange push button above an input with a small flat screwdriver.
4. Put the two wires of the trigger in one pair of the four inputs.
5. Release the orange push button.
6. Put the green connector back in the module.

7.2. Configure an Input module

1. Go in the Smappee App to **Settings > Smappee monitors > Infinity modules**.
2. Select the installed Input module.
3. If a physically installed Input module is not shown in the Smappee App, tap **Scan for modules** at the bottom of the **Infinity modules** screen.
4. Follow the steps shown in the Smappee App.
5. Repeat step 2 thru 4 for the configuration of each input.
6. Consult the data with the Smappee App or the Smappee Dashboard.
For more information, refer to the two following topics.

Monitor the input data with the Smappee App

1. Open the Smappee App.
2. Scroll in the **Dashboard** screen to **Live inputs**.
3. Tap a specific input to view its historical data.

Monitor the input data with the Smappee Dashboard

1. Open the Smappee Dashboard.
2. Add a **Input module values** card.

8. Add an Output module

The Output module has two outputs:

- Output 1 controls the circuit of the common (C) contact with normally open (NO) or normally closed (NC) contact
- Output 2 controls the circuit of the common (C) contact with normally open (NO) or normally closed (NC) contact

The outputs are indicated on the bottom of the module. An output has three horizontal contacts (NO, C and NC) next to each other.

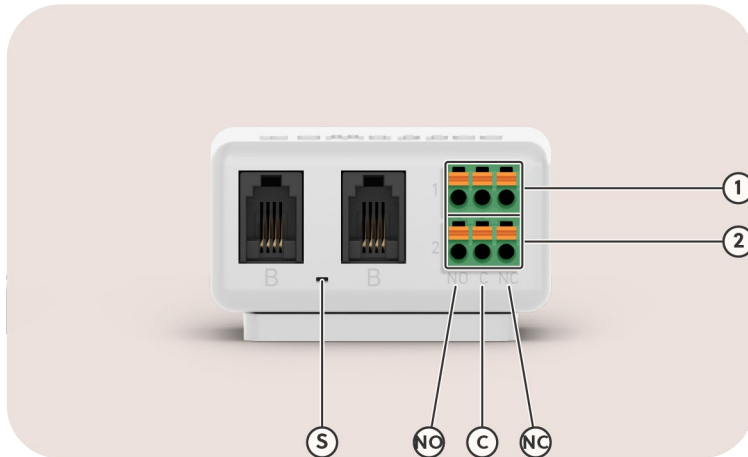

Image 13: View on an Output module

ID	Description	More information
1	Output 1	Each output has 3 terminals.
2	Output 2	
NO	Normally open	Make a normally open or normally closed circuit.
C	Common	
NC	Normally closed	
B	B-port	2 terminals to daisy chain the modules in the B-bus
S	Status LED	Shows the status of the Output module



NOTE

An Output module is compatible only with a Smappee Genius as gateway. If your Smappee Infinity has a Smappee Connect, you need to replace it with a Smappee Genius. For more information, refer to page 28.

Proceed as follows.

1. Install an Output module [\(page 25\)](#)
2. Configure an Output module [\(page 26\)](#)

8.1. Install an Output module

Context

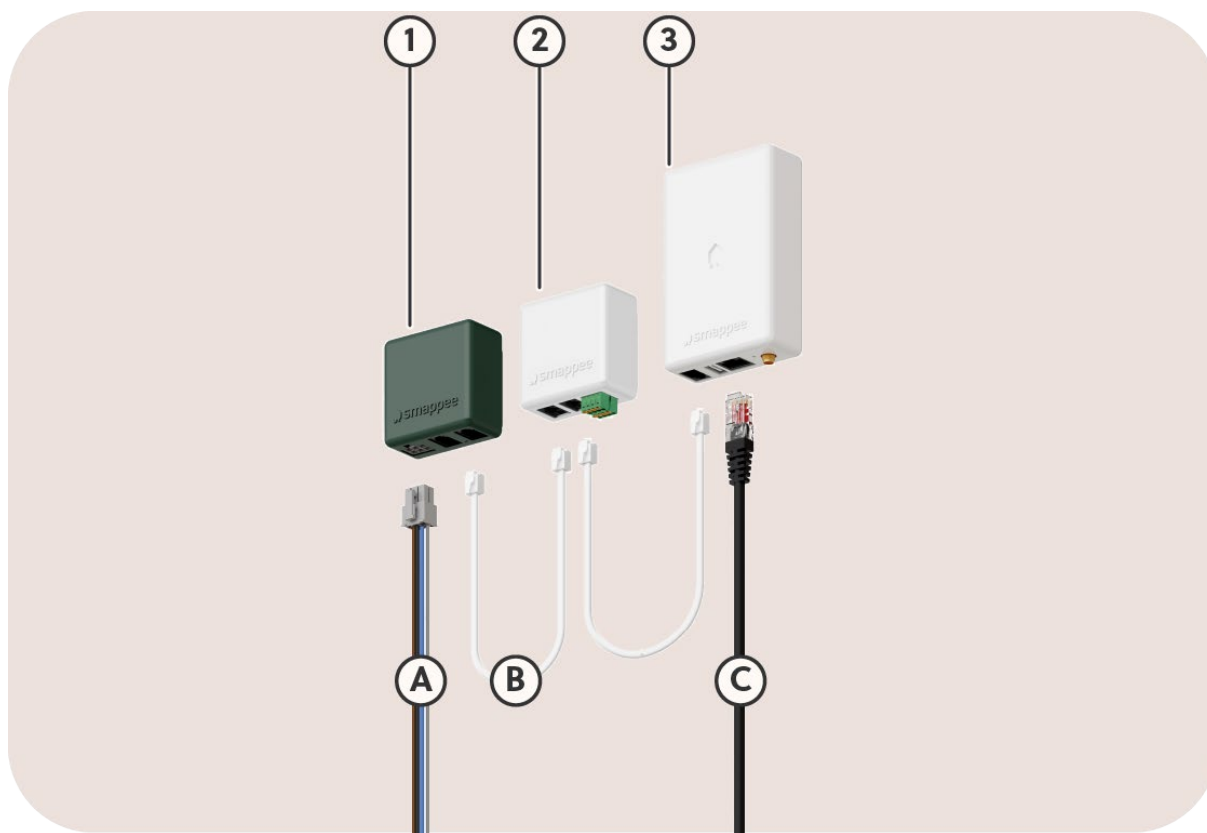

Image 14: Schematic view of the Smappee B-bus

Instructions

1. Make sure Smappee Infinity is installed and operational.
For more information, refer to Installation and configuration (page 11).
2. Make with the Smappee Bus cables a circuit with the B-terminals from the Power Box, through the Output module, until the Genius.



NOTE

Both B-terminals are identical. There is no special attention to the order of Input modules and Output modules necessary to make the circuit. For more information, refer to Smappee Bus (page 45).

The maximum number of Input modules and Output modules per Genius is 10.

3. Connect each appliance to the Output module.
For more information, refer to the following topic.

Connect an appliance to the Output module

1. Strip the two solid wires for 5 mm.
 - Use a solid wire with a diameter range 0.5 to 1.5 mm² (20 AWG to 15 AWG). Stranded cable is not recommended, because you need correct cable lugs.
 - If more than 5 A is to be switched, add a contactor and an appropriate circuit breaker.
 - For future ease of service, attach a label with the output number to both ends of the cable.
2. Pull the green connector away from the module to disconnect it from the module.
3. Push and hold the orange push button above an input with a small flat screwdriver.
4. Put the wire in the common (C) contact of an output.
5. Release the orange push button.
6. Repeat steps 2 thru 5 to put the other wire in the normally open (NO) or normally closed (NC) contact.
7. Put the green connector back in the module.

8.2. Configure an Output module

1. Go in the Smappee App to **Control > Smart devices**.
2. Tap the **+** button.
3. Tap the **Control other devices** button.
4. Select the installed Smappee Output module.
5. If a physically installed Output module is not shown in the Smappee App, tap **Scan for Output modules**.
6. Follow the steps shown in the Smappee App.
7. Repeat steps 2 thru 6 for the configuration of each output.
8. Control the appliance(s) with the Smappee App or the Smappee Dashboard.
For more information, refer to the following topic.

8.3. Control an output

You can control a single output or a group of outputs:

- Manually with the Smappee App: **Control > Smart devices**
- Manually with the **Smart devices** card of the Smappee Dashboard
- Automatically with the Smappee App, refer to the following topic:
Monitor the events which trigger the connected outputs with the Smappee App
- Automatically with the Smappee App, refer to the following topic:
Monitor the events which trigger the connected outputs with the Smappee Dashboard

Monitor the events which trigger the connected outputs with the Smappee App

1. Open the Smappee App.
2. Select the Smappee location in the dashboard.
3. Proceed as follows:
 - To monitor the past events, go to **Latest events**.
 - To review and set the status to on or off, go to **Control > Smart devices**
 - To review and set the automatic events, go to **Control > Automations**

Monitor the events which trigger the connected outputs with the Smappee Dashboard

1. Open the Smappee Dashboard.
2. Go to the **Events** card.

9. Replace a Connect by a Genius

To meet your requirements, it can be the initial installed Smappee Connect needs to be replaced by a Smappee Genius. The Genius has more functionalities than the Connect. There is a limitation that the Connect installed in an EV Wall Home or an EV One Home cannot be replaced by a Genius. If a module needs to be replaced, the serial numbers kept in the Smappee Cloud needs to be changed accordingly.

9.1. Installation instructions

Proceed as follows.

1. Stop the power supply to Smappee Infinity.
2. Disconnect the B-bus cable from the Smappee Connect.
3. Remove the Smappee Connect.
4. Install the Smappee Genius.
5. Connect the B-bus cable to the Smappee Genius.
6. Start the power supply to Smappee Infinity.

As a result, you can complete the module replacement in the Smappee App.

9.2. Configuration instructions

Proceed as follows.

1. Open the module replacement via **Settings > Smappee monitors > Infinity modules**.
2. Select the Smappee Connect.
3. Tap in the section **Replace your Smappee Connect** the **Start installation** button.
4. Follow the steps shown in the Smappee App.

10. Troubleshooting

Read the following tables related to:

- General troubleshooting (page 29)
- Genius troubleshooting (page 31)
- Connect series troubleshooting (page 33)

Read also the following topics:

- Reset the Wi-Fi connection of the Genius (page 35)
- Reset the Wi-Fi connection of the Connect (page 35)
- Reset the gateway (page 36)

10.1. General troubleshooting

General problem	Possible cause	Possible solution
Smappee Infinity does not switch on.	The power supply cable from the circuit breaker to the Power Box is connected incorrectly to the circuit breaker.	Verify that the power supply cable is connected according to the connection diagram. Refer to Connection diagrams (page 37).
	The circuit breaker is not switched on.	Switch on the circuit breaker.
	The gateway is not connected to port B of the Power Box	The gateway and Power Box are to be interconnected via Port B.
	The power supply cable to the circuit breaker is not correctly connected.	Connect the power supply cable to the Power Box according to the installation instructions.
One or all CT Hubs are not available in the Smappee App during installation. If your Infinity has one or more Solid Core CTs, read CT Hub as CT Hub and/or Solid Core CT.	RJ10 cables between CT Hubs are not connected properly.	Check that all required RJ10 cables are connected, and the bus termination plug is plugged in the free port of the last CT Hub. A green blinking LED light at a rate of 1 blink per 3 seconds is visible on input A of each CT Hub when the connection is operational.
		Check that all CT Hubs have a green flashing light. 1 blink per 3 seconds.
	The CT Hubs are not connected in the A-bus chain.	Connect the CT Hubs to port A of the Power Box.
	Check the LED blinking rate on the Power Box. When the LED is blinking once every second, there is a communication error between the CT Hubs and the Power Box.	Check that the CT Hubs are connected to port A of the Power Box and the gateway to port B. Carry out a restart by power cycling the Power Box after connecting the and gateway to the correct port. In the case of a custom RJ10 cable, check the operation of the RJ10 cable and review the Smappee Bus cable specification (page 45).

General problem	Possible cause	Possible solution
	More than 28 measuring points are connected to the Power Box.	In the app, go to Settings > Smappee monitors > Infinity modules and remove the obsolete CT Hub(s). You maybe need a multi-gateway setup.
No real-time measurements of the connected CTs.	The CT is not connected properly to the CT Hub.	Check the connector of the CT into the CT Hub.
	The CT is not closed properly.	Close the CT correctly.
During installation: the Smappee App states that the serial number of the gateway is invalid.	The serial number is wrong.	Check if you are scanning the serial number of the gateway.
	The gateway has already been installed at another location.	Carry out a factory reset on the gateway.
The main feed measurement values are incorrect.	The power connectors L1, L2, L3 do not correspond with the current phases (phase- mapping).	Use a multimeter to check that the voltage L1, L2, L3 corresponds with the load configuration of the grid (phase setting). For more information, refer to Validation of the Smappee Infinity installation (page 20).
The Output module is not available in the Smappee App.	The Genius has not yet scanned the module.	Disconnect and reconnect the RJ10 cable to the Genius or do the following in the Smappee App. Go to Settings > Smappee monitors > Infinity modules Push Scan for modules .
	The module is connected to the wrong bus.	The module needs to be connected to the B-bus chain.
The Input module is not available in the Smappee App.	The Genius has not yet scanned the module.	Do the following in the Smappee App. Go to Settings > Smappee monitors > Infinity modules Push Scan for modules .
	The module is connected to the wrong bus.	The module needs to be connected to the B-bus chain.

10.2. Genius troubleshooting

Genius problem	Possible cause	Possible solution
The LED of the Genius flashes red.	The Genius had a previously working internet connection but has now lost its connection to the internet.	Verify if the internet connection is still active. If this was caused by a temporary outage, then the Genius will automatically reconnect to the internet after 5 minutes. You can also disconnect and reconnect the RJ10 cable to speed up the process but know that you will lose data.
	The Wi-Fi password has been changed.	The Genius needs to be reconfigured with the correct Wi-Fi settings. Go in the Smappee App to Settings > Smappee monitors > Infinity modules > Smappee Genius > Change your setup and follow the steps shown in the app.
The LED of the Genius is blue continuous.	The Genius is still booting up or installing an update.	Wait for 5 minutes.
	The Genius is blue for more than 10 minutes.	Disconnect and reconnect the RJ10 cable to reboot the Genius. Wait for 5 minutes. If the problem persists, contact Smappee Support.
The LED on the Genius flashes blue after start-up with a network cable.	The network cable is not connected correctly.	Check network cable connection. Disconnect and reconnect the RJ10 cable to reboot the Genius and let it search for internet connection.
		Check with a laptop or other Ethernet compatible device if the network cable is working. Ping to an internet address (For example, 8.8.8.8).
The LED of the Genius is red after start-up with a network cable.	The network cable is not connected correctly.	Check network cable connection. Disconnect and reconnect the RJ10 cable to reboot the Genius and let it search for internet connection.
		Check with a laptop or other Ethernet compatible device if the network cable is working. Ping to an internet address (For example, 8.8.8.8).
	The internet connection is down.	Check and solve the internet connection. Disconnect and reconnect the RJ10 cable to reboot the Genius and let it search for internet connection.
	A firewall blocks outgoing communication.	The Smappee servers cannot be reached. Check the firewall rules. For more information, refer to Wi-Fi connection properties and firewall rules (page 47).

Genius problem	Possible cause	Possible solution
The LED of the Genius remains blue blinking during the Wi-Fi connection attempt.	The connection to the Wi-Fi failed.	Check if the Wi-Fi settings are compatible. For more information, refer to Wi-Fi connection properties and firewall rules (page 47).
		Make sure the Wi-Fi password you entered is correct.
		Check if the Wi-Fi signal is strong enough.
The LED of the Genius is purple or yellow after a factory reset.	The reset button was not pressed long enough.	Press the reset button for approximately 20 seconds until the LED is blue
The SSID of the Wi-Fi does not appear in the Wi-Fi list of the Genius.	Smappee Infinity booted faster than the Wi-Fi router.	Disconnect and reconnect the RJ10 cable to reboot the Genius and let it search for Wi-Fi connection.
	The SSID is not supported.	For more information, refer to Wi-Fi connection properties and firewall rules (page 47).
	The Wi-Fi signal is not strong enough.	Make sure the Genius is close enough to the Wi-Fi router / repeater
The CTs are measuring current, but no power is being calculated.	The Connect did not receive the configuration correctly.	Resend the configuration via the Smappee App. Go to Settings > Smappee monitors > Load configuration . Push Apply changes . If this is not shown, make a change and undo the change to a load or CT.

10.3. Connect series troubleshooting

Connect problem	Possible cause	Possible solution
The LED of the Connect flashes red.	The Connect had a previously working internet connection but has now lost its connection to the internet.	Verify if the internet connection is still active. If this was caused by a temporary outage, then the Connect will automatically reconnect to the internet after 5 minutes. You can also disconnect and reconnect the RJ10 cable to speed up the process but know that you will lose data.
	The Wi-Fi password has been changed.	The Connect needs to be reconfigured with the correct Wi-Fi settings. Go in the Smappee App to Settings > Smappee monitors > Infinity modules > Smappee Connect > Change your setup and follow the steps in the app.
	The 4G Connect lost its connection to the mobile network.	If this happens during installation then this means that the mobile network is unstable and does not have a strong enough signal, please either reposition the 4G Connect to receive a better signal. If this happens after a couple of days, the Connect will automatically attempt to reconnect after a maximum of 24 hours. Disconnect and reconnect the RJ10 cable to reboot the 4G Connect and let it search for internet connection.
The LED of the Connect is blue continuous.	The Connect is still booting up or installing an update.	Wait for 5 minutes.
	The Connect is blue for more than 10 minutes.	Disconnect and reconnect the RJ10 cable to reboot the Connect. Wait for 5 minutes. If the problem persists, contact Smappee Support.
The LED of the Connect is red after start-up with a network cable.	The network cable is not connected correctly.	Check the connection of the network cable. Disconnect and reconnect the RJ10 cable to reboot the Connect and let it search for internet connection.
		Check with a laptop or other Ethernet compatible device if the network cable is working. Ping to an internet address (For example, 8.8.8.8).
	The internet connection is down.	Check and solve the internet connection. Disconnect and reconnect the RJ10 cable to reboot the Connect and let it search for internet connection.

Connect problem	Possible cause	Possible solution
	A firewall blocks outgoing communication.	The Smappee servers cannot be reached. Check the firewall rules. For more information, refer to Wi-Fi connection properties and firewall rules (page 47).
The SSID of the Wi-Fi does not appear in the Wi-Fi list of the Connect.	Smappee Infinity booted faster than the Wi-Fi router.	Disconnect and reconnect the RJ10 cable to reboot the Connect and let it search for internet connection. The Wi-Fi is scanned when the gateway is booting up.
	The SSID is not supported	For more information, refer to Wi-Fi connection properties and firewall rules (page 47).
	The Wi-Fi signal is not strong enough	Make sure the Connect is close enough to the Wi-Fi router / repeater
The Connect remains blue blinking during the Wi-Fi connection attempt.	Connection to the Wi-Fi failed.	Check if the Wi-Fi settings are compatible. For more information, refer to Wi-Fi connection properties and firewall rules (page 47).
		Make sure the Wi-Fi password you entered is correct.
		Check if the Wi-Fi signal is strong enough.
The LED of the Connect is green breathing but does not activate.	The Connect is plugged into port A of the Power Box.	Please make sure that the Connect is linked to Port B of the Power Box.
The LED of the Connect is green continuous.	Internet connection is down.	Check and solve the internet connection. Disconnect and reconnect the RJ10 cable to reboot the Connect and let it search for internet connection.
	A firewall blocks outgoing communication.	The Smappee servers cannot be reached. Check the firewall rules. For more information, refer to Wi-Fi connection properties and firewall rules (page 47).
The CTs are measuring current, but no power is being calculated.	The Connect did not receive the configuration correctly.	Resend the configuration with the Smappee App. Select Settings > Smappee monitors > Load configuration > Apply changes . If the Apply changes button is not shown, make a change to a load. As a result, the button is shown and you can undo your change.

10.4. Reset the Wi-Fi connection of the Genius

If the Genius must be connected to another Wi-Fi network or the authentication password must be changed, use the Smappee App:

1. Go to **Settings > Smappee monitors > Infinity modules > Smappee Genius > Change your setup.**
2. Follow the steps shown in the Smappee App.

10.5. Reset the Wi-Fi connection of the Connect

If the Connect must be connected to another Wi-Fi network or the authentication password must be changed, use the Smappee App:

1. Go to **Settings > Smappee monitors > Infinity modules > Smappee Connect > Change your setup.**
2. Follow the steps shown in the Smappee App.

10.6. Reset the gateway

If you want to start with the factory settings, push and hold the reset button (R) for 3 seconds with a small pin.



NOTE

When resetting a Genius, you need to hold the reset button for approximately 20 seconds, until the LED emits a blue colour. The Genius will first emit a red colour, then a yellow colour, then no colour and finally a blue colour.

For more information, refer to Colour code explanation (page 37).

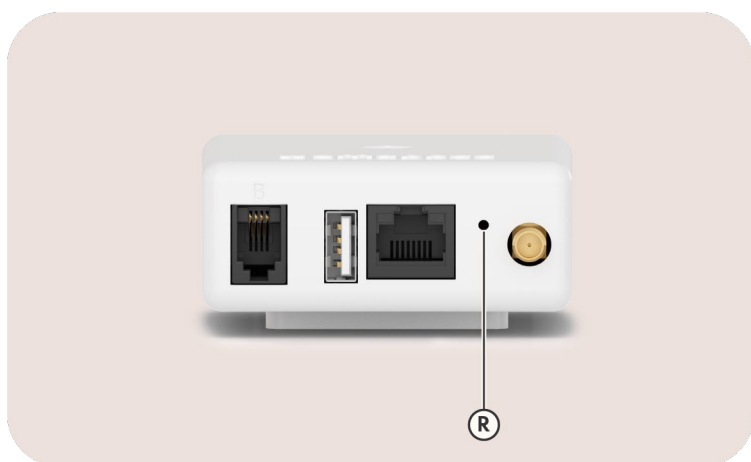

Image 15: View on the reset button of the Genius



Image 16: View on the Connect, WiFi Connect and 4G Connect reset buttons

Annexes

Connection diagrams

The following connection diagrams give a schematic representation of:

- The live conductors where energy flows from the grid or your energy sources to the different loads of the electric installation
- Locations where the current transformer should be placed around live conductors, with the arrow pointing in the same direction as the energy flow

For other region specifications not included in this annex, please contact Smappee.

Connection diagram – 1 x 230 V

L1	Brown wire for the phase 1 conductor	CB	Circuit breaker for Smappee Infinity
N	Blue wire for the neutral or second phase if there is no neutral	PB	Power Box
1	Phase measurement of the load 1	CT	CT Hub
2	Phase measurement of the load 2	A	A-bus cable
3	Phase measurement of the load 3		
4	Phase measurement of the load 4		

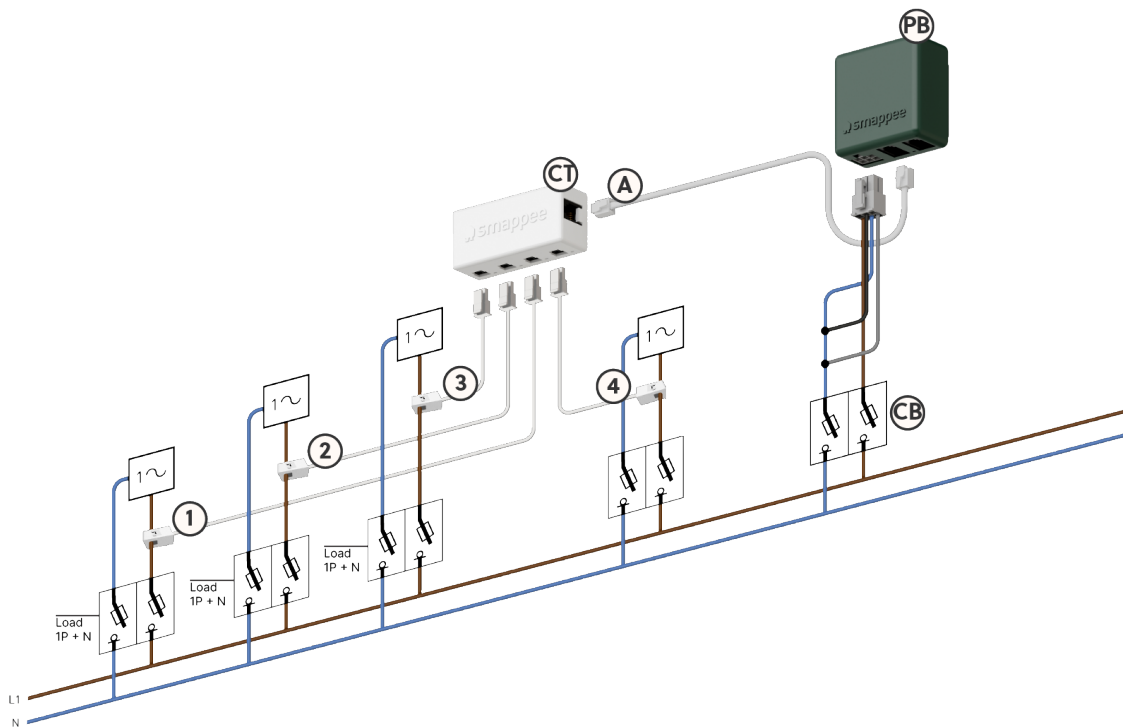

WARNING

The above wiring and colour scheme is indicative. National regulations must be respected. Wiring for Europe must be at least 1mm² / 600 V and protected by a 6 A circuit breaker.

Connection diagram – 3 x 400 V + N

L1	Brown wire for the phase 1 conductor	CB	Circuit breaker for Smappee Infinity
L2	Black wire for the phase 2 conductor	PB	Power Box
L3	Gray wire for the phase 3 conductor	CT	CT Hub
N	Blue wire for the neutral	A	A-bus cable
1	Phase 1 of the 3-phase load		
2	Phase 2 of the 3-phase load		
3	Phase 3 of the 3-phase load		
4	Phase of the 1-phase load		

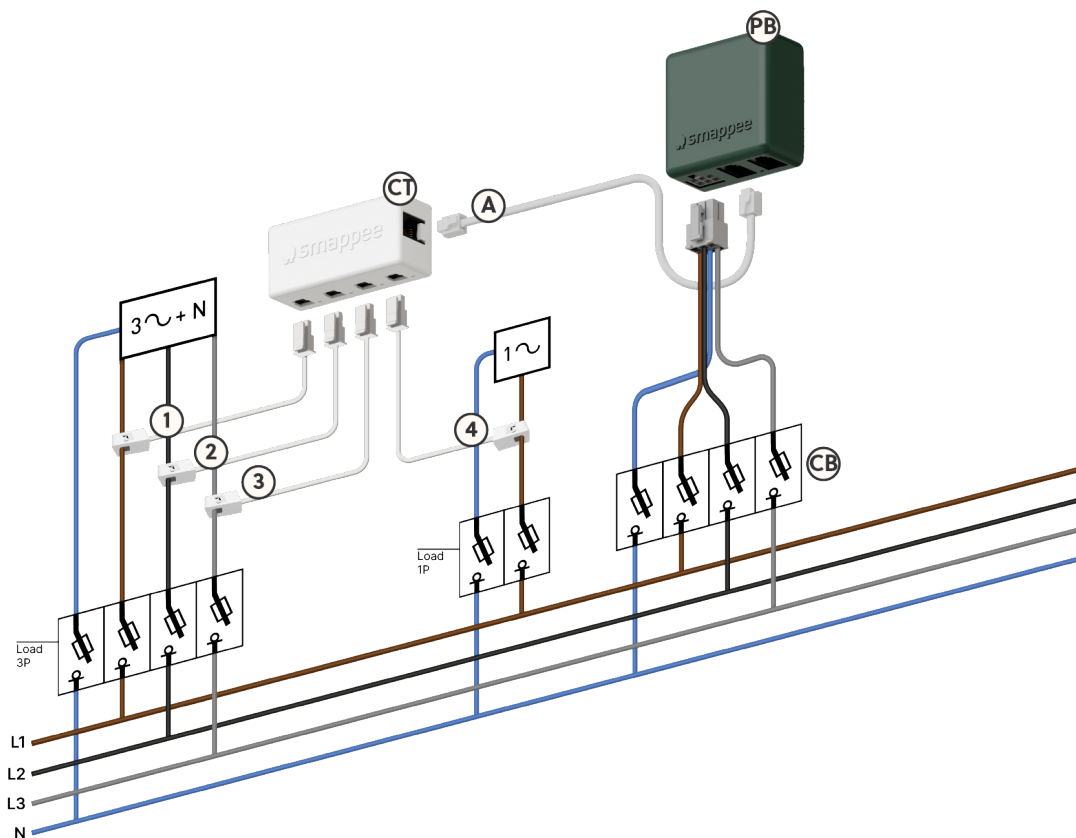

WARNING

The above wiring and colour scheme is indicative. National regulations must be respected. Wiring for Europe must be at least 1mm² / 600 V and protected by a 6 A circuit breaker.

Connection diagram – 3 x 230 V

L1	Brown wire for the phase 1 conductor	CB	Circuit breaker for Smappee Infinity
L2	Black wire for the phase 2 conductor	PB	Power Box
L3	Gray wire for the phase 3 conductor	CT	CT Hub
1	Phase 1 of the 3-phase load	A	A-bus cable
2	Phase 2 of the 3-phase load		
3	Phase 3 of the 3-phase load		
4	Phase of the 1-phase load		

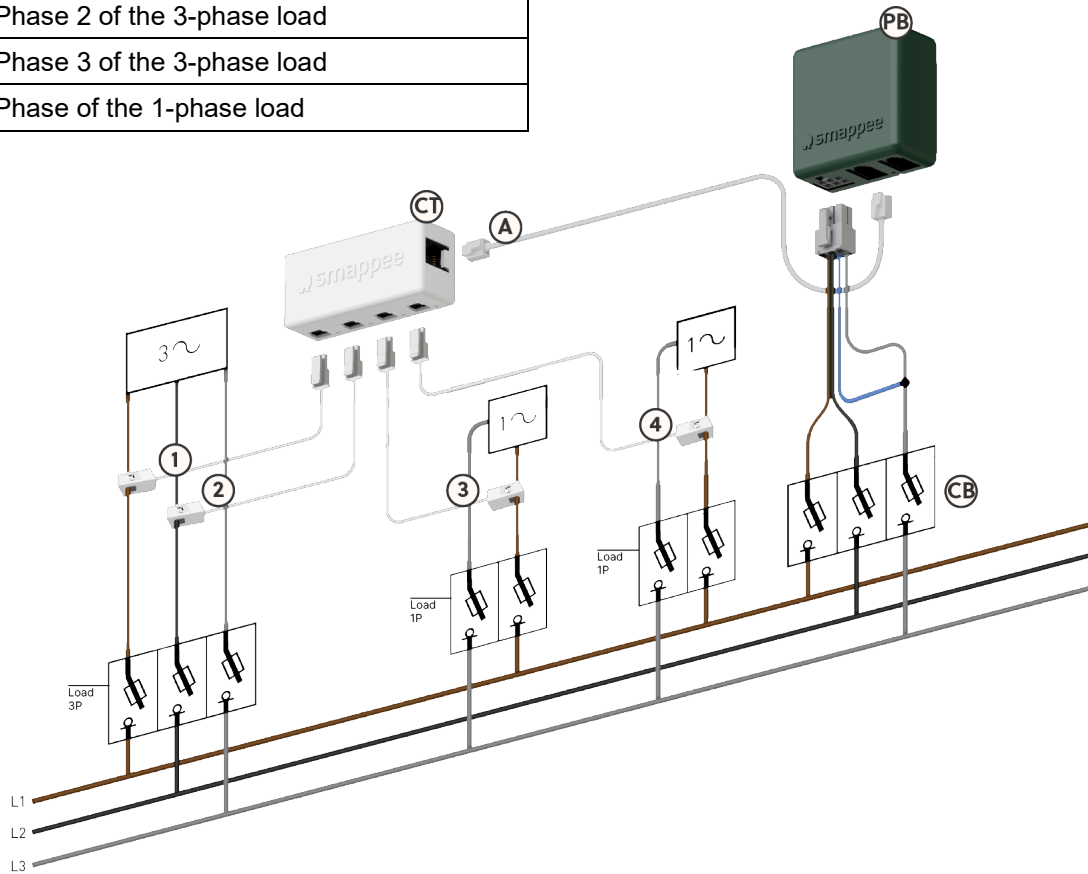

WARNING

The above wiring and colour scheme is indicative. National regulations must be respected. Wiring for Europe must be at least 1mm² / 600 V and protected by a 6 A circuit breaker.



NOTE

- All 3-phase loads must be measured with L1 and L2 (grid, solar, sub circuits).
- During the configuration of the Infinity with the Smappee App, you need to indicate the maximum current. Enter 60 % of the value indicated on the main circuit breaker.
- For single phase loads, connect and configure the clamp as follows:

Single phase load powered by	Connect the clamp around	Configure in Smappee App
L1 and L3	L1	L1
L2 and L3	L2	L2
L1 and L2	L1	L3

Connection diagram – 2 x 120/240 V

A	Black wire for the phase 1 conductor	CB	Circuit breaker for Smappee Infinity
B	Red wire for the phase 2 conductor	PB	Power Box
N	White wire for the neutral conductor	CT	CT Hub
1	Phase 1 of the 2-phase load	A	A-bus cable
2	Phase 2 of the 2-phase load		
3	Phase 1 of the 1-phase load		
4	Phase 2 of the 1-phase load		

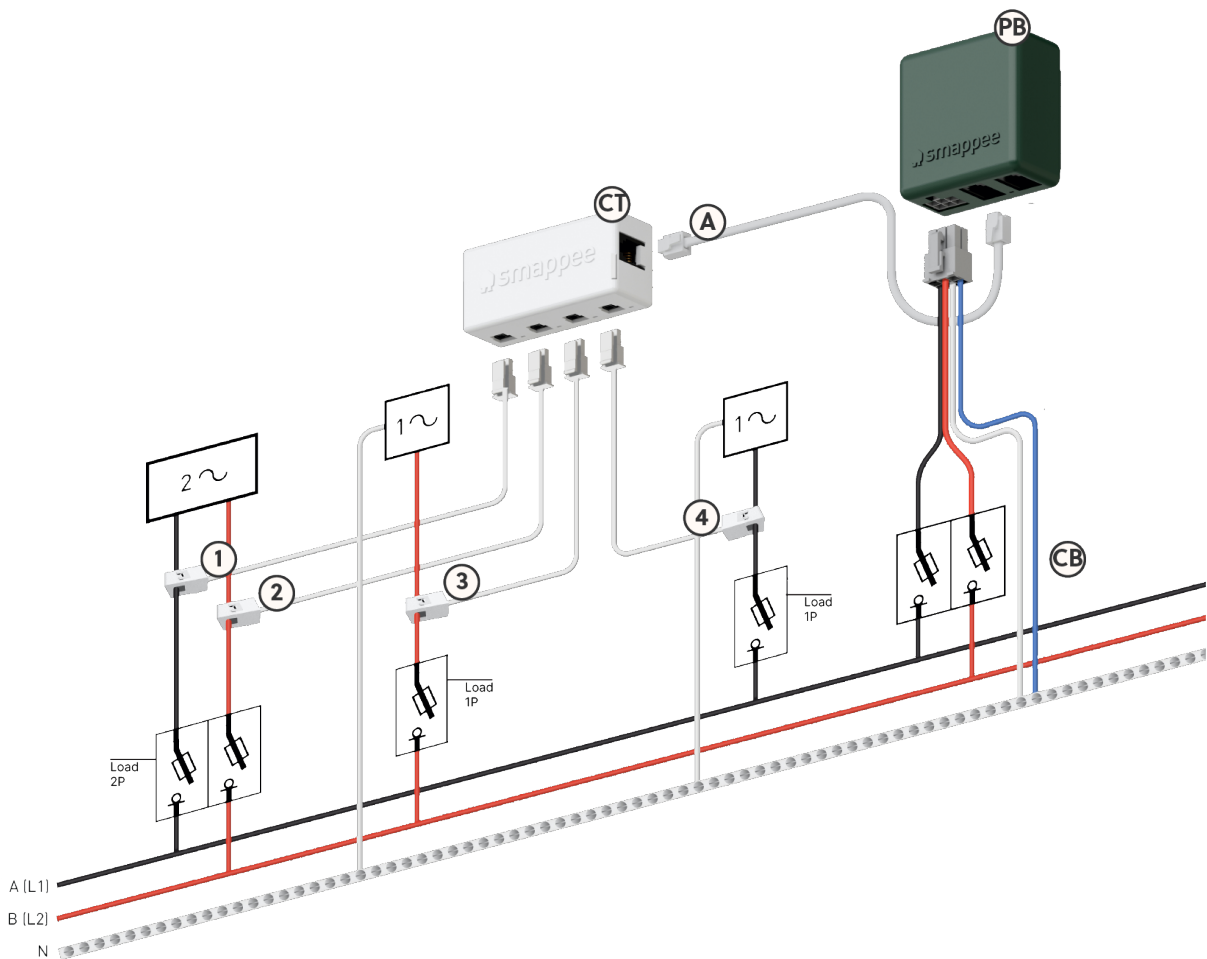

WARNING

The above wiring and color scheme is indicative. National regulations must be respected. Wiring for the Americas region should be minimum 18 AWG/600 V UL-style 1015 protected by a 6 A circuit breaker and maximum 16 AWG/600 V UL-style 1015 protected by a 6 A or 10 A circuit breaker. The circuit breaker must comply with UL 489.

Connection diagram – 3 x 120/208 V or 3 x 277/480 V

L1	Black wire for the phase 1 conductor	CB	Circuit breaker for Smappee Infinity
L2	Red wire for the phase 2 conductor	PB	Power Box
L3	Blue wire for the neutral conductor	CT	CT Hub
N	White wire for the neutral conductor	A	A-bus cable
1	Phase 1 of the 3-phase load		
2	Phase 2 of the 3-phase load		
3	Phase 3 of the 3-phase load		
4	Phase 1 of the 1-phase load		

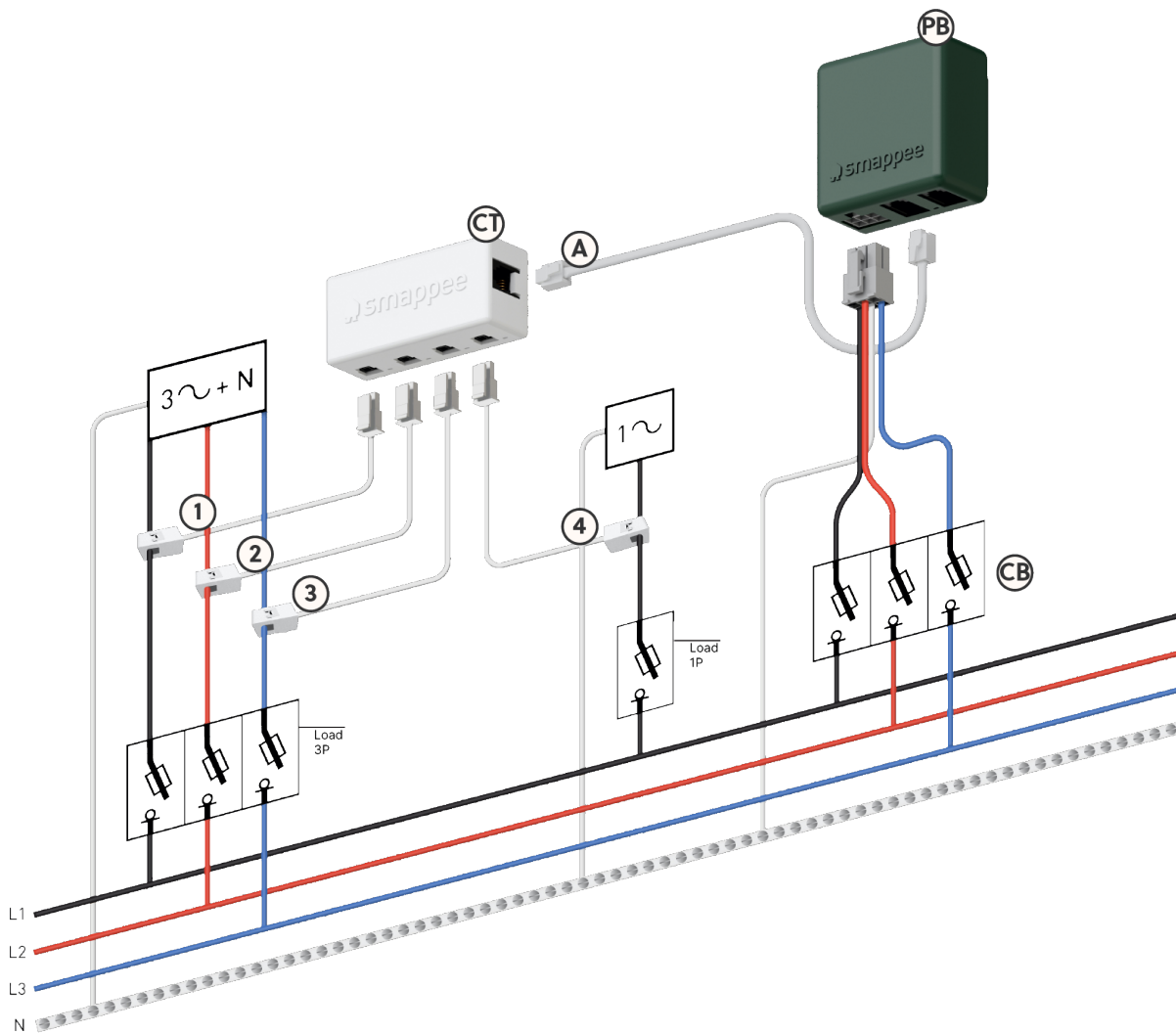

WARNING

The above wiring and color scheme is indicative. National regulations must be respected. Wiring for the Americas region should be minimum 18 AWG/600 V UL-style 1015 protected by a 6 A circuit breaker and maximum 16 AWG/600 V UL-style 1015 protected by a 6 A or 10 A circuit breaker. The circuit breaker must comply with UL 489.

Declaration of conformity

Declaration of conformity

We,
Smappee nv
Evolis 104
B-8530 Harelbeke, Belgium

following the provision of the following EC Directives:

- 2014/35/EU The Low Voltage Directive
- 2014/30/EU The Electromagnetic Compatibility Directive
- 2014/53/EU The Radio Equipment Directive

hereby declare that the product:

Smappee Infinity with subparts:
Smappee Genius (MOD-GW-1), Smappee Wi-Fi Connect (MOD-GW-2), Smappee Connect (MOD-GW-3),
Smappee 4G Connect (MOD-GW-4), Smappee Power Box (MOD-VAC-1), Smappee CT Hub (MOD-IAC-1),
Solid Core 3-Phase CT (MOD-IAC-2), Smappee Output module (MOD-OUT-1), Smappee Input module
(MOD-IN-1) and P1/S1 module (MOD-P1S1-1)

is in conformity with the applicable requirements of the following documents

- Emissions:
Non Radio Function : (EN61326-1 : 2013)
Radiated Emission: EN 55011:2009 / EN 55032:2015 (Class B)
Conducted Emission: EN 55011:2009 / EN 55032:2015 (Class B)
Harmonic current Emission: EN 61000-3-2:2005 + A1:2008 + A2:2009
Flicker: EN 61000-3-3:2008
Radio Function : (EN301 489-1 : V2.2.0 2017) / (EN301 489-17 : V3.2.0 2017)
- Immunity:
Non Radio Function : (EN61326-1 : 2013)
ESD : EN 61000-4-2:2008 / EN 61000-4-2 :2009
Radiated immunity : EN 61000-4-3:2006 + A1:2007 + A2: 2010
Power frequency magnetic field: EN 61000-4-8:2009
Voltage dips/interruptions: EN 61000-4-11:2004
Common Mode Immunity: EN 61000-4-6:2008 / EN 61000-4-6:2009
Burst : EN 61000-4-4:2004 / EN 61000-4-4:2012
Surge: EN 61000-4-5:2005 / EN 61000-4-5:2006
Radio Function : (EN301 489-1 : V2.2.0 2017) / (EN301 489-17 : V3.2.0 2017)
- Safety:
Non Radio Function : IEC 61010-1 Ed 3.0 (2010-06) + A1:2016
Radio Function : IEC 60950-1
- Spectrum:
EN 300 328 V2

Harelbeke, Belgium, January 13, 2023

Authorized signatory



CEO Smappee



Components overview

Smappee Infinity components

Description	Article number
Genius	I1-GW-1
Wi-Fi Connect	I1-GW-2
Connect	I1-GW-3
4G Connect	I1-GW-4
Input module	I1-INP-1
Output module	I1-OUT-1
Power Box	I1-VAC-1 (I1-VAC-1-US for US)
CT Hub	I1-IAC-1
Solid Core 3-Phase CT	I1-IAC-2
Split Core CT 50 A with long cable (180 cm)	AC-CT-50A
Split Core CT 100 A	AC-CT-100A
Split Core CT 200 A	AC-CT-200A
Split Core CT 400 A	AC-CT-400A
Split Core CT 50 A with short cable (30 cm)	AC-CT-S-50A
Rogowski coil 0 – 400 A	AC-RSCT-4CM
Rogowski coil 0 – 1600 A	AC-RSCT-12CM
Rogowski coil 0 – 4000 A	AC-RSCT-19CM
Rogowski coil 0 – 10000 A	AC-RSCT-30CM
Wall mounting plate kit (8 pieces)	AC-IMPW-8
DIN mounting plate kit (4 pieces)	AC-IMPD-4
Smappee Bus cable – 40 cm (15.75 inches) ¹	AC-IBC40
Smappee Bus cable – 150 cm (59 inches) ¹	AC-IBC150
Smappee Bus cable set – 100 m (109 yards) - 50 RJ10 connectors ¹	AC-IBCS-100m
Smappee Infinity Modbus Energy Meter cable (RJ10 to USB)	AC-IBC-RS485
Teltonika RUT240 4G Router (for 3G/4G internet connection)	AC-SP-LU2

¹ You can also use a custom RJ10 cable, refer to Smappee Bus (page 45).

Smappee Bus

You can order the following items related to the Smappee Bus.

Description	Article number
Smappee Bus cable – 15.75 inches (40 cm)	AC-IBC40
Smappee Bus cable – 59 inches (150 cm)	AC-IBC150
Smappee Bus cable set – 109 yards (100 m) and 50 RJ10 connectors	AC-IBCS-100m

If the Smappee Bus cable is not sufficient, you can use a custom RJ10 cable. For more information, refer to the following topics:

- Bus cable specifications
- Bus limitations

Bus cable specifications

- A cable containing 2 unshielded twisted pairs (e.g. Cat 5 UTP cable). Shielded cable may also be used (e.g. Cat 6 UTP cable).
- Pins 1 and 4 and pins 2 and 3 must be twisted pairs.

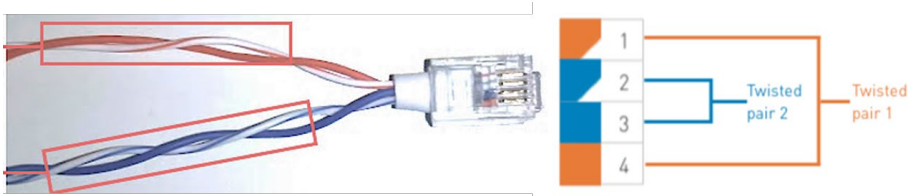

Image 17: Twisted pairs

- Straight connection: pin 1 to 1, etc.
- Characteristic impedance of 100 ohm.

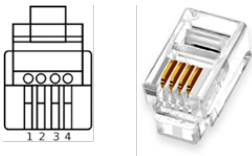

Image 18: Connector

- AWM style 2835: 60°/30 V – 24 AWG.

Bus limitations

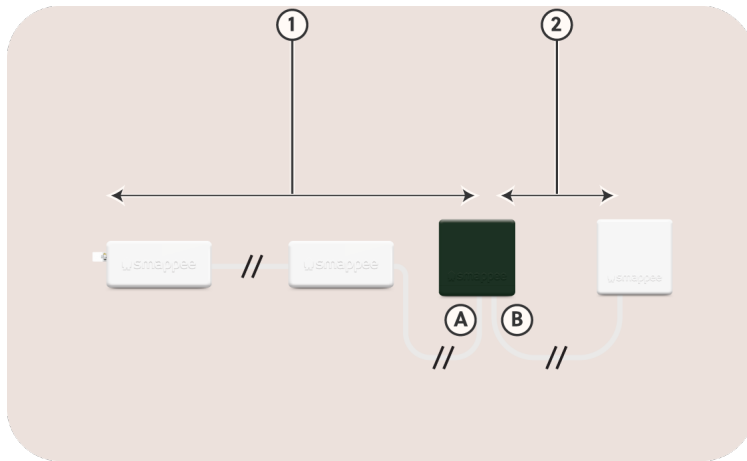

Image 19: Limitations to the Smappee A-bus and Smappee B-bus

Smappee Bus	More information
A	<p>The total length of the CT bus (1) must be less than 100 meters (109 yards). There is a maximum of 28 measuring points:</p> <ul style="list-style-type: none"> • A CT Hub has 4 measuring points. • A Solid Core 3-Phase CT has 3 measuring points.
B	<p>The total length of the data bus (2) must be less than 500 meters (545 yards).</p>

Wi-Fi connection properties and firewall rules

Wi-Fi Connection properties

- 2.4 GHz Wi-Fi required, preferably with automatic channel selection.
- Networks without DHCP server are not supported.
The DHCP of your router assigns the IP address of your Smappee.
- WPA or WPA2 encryption mandatory.
The maximum number of characters for the WPA2/PSK encryption key is 20.
- Networks without security are not supported.
- SSID must be visible and should not be hidden during installation.
- Not all characters are allowed in the SSID or Wi-Fi password
- Allowed characters for SSID: [a-z],[A-Z],[0-9],[!#\$%&'()*+,-./:;<>?@[^_`{|}~]
- Allowed characters for Wi-Fi password: [a-z],[A-Z],[0-9],[!#\$%&'()*+,-./:;<>?@[^_`{|}~]
- MAC filtering must not be active on the router.
- Your firewall should allow Smappee to create outbound secure HTTP connections.

Firewall rules

No specific firewall settings are required in your network. If you use a firewall, use the commonly applied secure firewall rules:

- Inbound communication: All inbound ports closed. No port forwarding.
- Outbound communication: All outbound ports allowed.

Colour code explanation

Smappee Genius

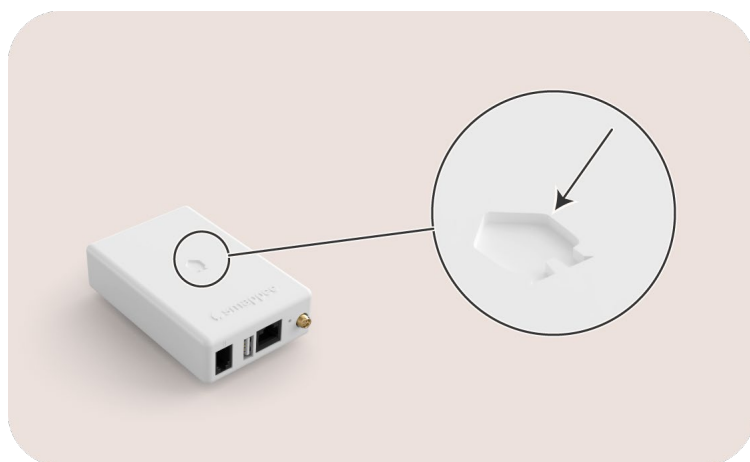







Image 20: Position of the LED on the Smappee Genius

LED	LED status	Meaning	More information
	Blue continuous	Starting up	The Genius is starting up. If this takes more than 10 minutes, please contact support. The light may briefly go off during this process.
	Blue pulsing	Ready for connecting	The Genius is ready to be connected to the local Wi-Fi network.
	Green continuous	Connecting	Network connection is successful, but the Genius is not yet activated on a location. <ul style="list-style-type: none"> Ethernet: Connected to the local network. Wi-Fi: Connected to the Wi-Fi and the local network (i.e. the Wi-Fi password is correct)
	Green breathing	All good	The Genius operates correctly.
	Red flashing	No connection to the Smappee Cloud	The Genius had a working internet connection but has lost its connection to the Smappee Cloud.
	Red continuous	No connection to the internet	The Genius has no connection to the internet during start-up. Connection issue.

Smappee Connect series

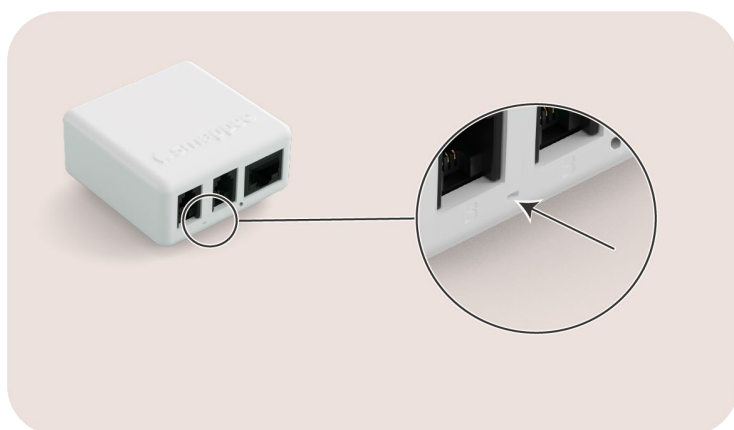







Image 21: Position of the LED on the Smappee Connect

LED	LED status	Meaning	More information
	Blue continuous	Starting up	The Connect is starting up. If this takes more than 30 seconds, please contact support.
	Blue pulsing	Ready for connecting	The Connect is ready to be connected to the network.
	Green continuous	Connecting	The Connect is connecting to the internet and must become <i>Green breathing</i> . If this takes more than 2 minutes, please contact support.
	Green breathing	All good	The Connect operates correctly.
	Red flashing	No connection	The Connect has no connection to the internet during start-up. Find the cause of the connection issue or contact support.

Smappee Power Box

LED status	Meaning
Status LED is pulsing once every 3 seconds.	The Power Box is powered on and operating correctly.
Status LED is pulsing once every 1 second.	Smappee Bus B error.

Smappee CT Hub

LED status	Meaning
LED at input A, B, C or D 3 pulses per second, on any of the inputs A, B, C, D.	Indication of the selected CT input during the CT configuration.
LED at input A Short pulse every 3 seconds.	The CT Hub is powered on and operating correctly.
LED at input A One pulse every second.	Communication error.
LED at input A 2 pulses per second.	Configuration problem.

Smappee Solid Core 3-Phase CT

LED status	Meaning
LED at input A, B, C or D 3 pulses per second, on any of the inputs A, B, C, D.	Indication of the selected input during configuration.
LED at input A Short pulse every 3 seconds.	The Solid Core 3-Phase CT is powered on and operating correctly.
LED at input A One pulse every second.	Communication error.
LED at input A 2 pulses per second.	Configuration problem.

Smappee Input module

LED status	Meaning
LED Short pulse every 3 seconds.	De Input module is powered on and operating correctly.
LED One pulse every second.	No communication or communication error.
LED Short pulse every 1 second	Configuration problem.
Input LED (one for each input)	ON when input is closed, or a pulse is given.

Smappee Output module

LED status	Meaning
LED Short pulse every 3 seconds.	De Output module is powered on and operating correctly.
LED 3 pulses per second.	Indication of the selected output during configuration.
LED Short pulse every 1 second	No communication, communication error or configuration problem