

V1.2 2025-10-21

# Residential All-In-One Energy Storage System

**ESA 3.0-10kW**

GW5.1-BAT-D-G20

GW8.3-BAT-D-G20

GW5.1-BAT-D-G21

GW8.3-BAT-D-G21

## Solutions Manual

**GOODWE**

## Copyright Statement

**Copyright©GoodWe Technologies Co., Ltd. 2025. All rights reserved.**

No part of this manual can be reproduced or transmitted to the public platform in any form or by any means without the prior written authorization of GoodWe Technologies Co., Ltd.

## **Trademarks**

**GOODWE** and other GOODWE trademarks are trademarks of GoodWe Technologies Co.,Ltd. All other trademarks or registered trademarks mentioned in this brochure are the property of their respective owners.

## **NOTICE**

The information in this document is subject to change due to product updates or other reasons. This document cannot replace the product labels or the safety precautions unless otherwise specified. All descriptions in the manual are for guidance only.

## Table of Contents

1 About This Manual	12
1.1 Overview	12
1.2 Applicable Model	12
1.3 Symbol Definition	13
2 Safety Precautions	14
2.1 General Safety	14
2.2 Personnel Requirements	14
2.3 System Safety	15
2.3.1 PV String Safety	16
2.3.2 Inverter Safety	16
2.3.3 Battery Safety	17
2.3.4 Smart Meter Safety	20
2.4 Safety Symbols and Certification Marks	20
2.5 EU Declaration of Conformity	22
2.5.1 Equipment with Wireless Communication Modules	22
2.5.2 Devices without Wireless Communication Modules (Excluding Batteries)	22
2.5.3 Battery	23
3 System Introduction	24
3.1 System Overview	24
3.2 Product Overview	38

3.2.1 Residential All-In-One Energy Storage System	38
3.2.2 Smart Meter	43
3.2.3 Smart Dongle	44
3.3 Supported Grid Types	45
3.4 System Modes	45
3.5 Functional Features	55
4 Check and Storage	58
4.1 Check Before Receiving	58
4.2 Deliverables	58
4.2.1 Inverter Deliverables	58
4.2.2 Battery Deliverables	60
4.2.3 Smart Meter Deliverables	61
4.2.3.1 Smart Meter Deliverables (GMK110)	61
4.2.3.2 Smart Meter Deliverables (GM330)	62
4.3 Storage	62
5 Installation	65
5.1 Installation Requirements	65
5.1.1 Installation Environment Requirements	65
5.1.2 Installation Space Requirements	66
5.1.3 Tool Requirements	67
5.2 Equipment Handling	69
5.3 Equipment Installation	70

5.4 Installing the Smart Meter.....	74
6 System Wirings.....	76
6.1 System Wiring Electrical Block Diagram.....	76
6.2 Detailed System Wiring Diagram.....	79
6.2.1 Detailed System Wiring Diagram for Single Inverter.....	80
6.2.2 Detailed System Wiring Diagram for Parallel System.....	88
6.3 Preparing Materials.....	92
6.3.1 Preparing Breakers.....	93
6.3.2 Preparing Cables.....	95
6.4 Connecting the PE Cable.....	97
6.5 Connecting the PV cable.....	98
6.6 Connecting the AC Cable.....	100
6.7 Connecting the Meter Cable.....	103
6.8 Connecting the Inverter Communication Cable.....	106
7 System Commissioning.....	111
7.1 Check Before Power ON.....	111
7.2 Power ON.....	111
7.3 Installing Protective Cover.....	114
7.4 Indicators.....	114
7.4.1 Inverter Indicators.....	114
7.4.2 Battery Indicators.....	117
7.4.3 Smart Meter Indicator.....	118

7.4.4 Smart Dongle Indicator.....	119
8 Rapid System Configuration.....	122
8.1 Downloading the App.....	122
8.1.1 Downloading SolarGo App.....	122
8.1.2 Downloading SEMS+ APP.....	122
8.2 Connecting the Energy Storage Inverter (Bluetooth).....	123
8.3 Connect the Smart Dongle.....	124
8.4 Setting Communication Parameters.....	125
8.4.1 Setting Privacy and Security Parameters.....	126
8.4.2 Setting the WLAN/LAN Parameters.....	129
8.4.3 Setting RS485 Communication Parameters.....	131
8.5 Quick System Setup.....	131
8.5.1 Quick System Setup (Type I).....	133
8.6 Power Plant Creation.....	137
9 System Commissioning.....	139
9.1 Commissioning Method Overview.....	139
9.2 SolarGo APP.....	139
9.2.1 APP Introduction.....	139
9.2.1.1 Downloading and Installing the App.....	139
9.2.1.2 Connection Method.....	140
9.2.1.3 Introduction of Interface.....	141
9.2.2 Connecting the Energy Storage Inverter (Bluetooth).....	142

9.2.3 Connect the Smart Dongle.....	144
9.2.4 Introduction of the Energy Storage Inverter Interface.....	145
9.2.5 Setting Communication Parameters.....	147
9.2.5.1 Setting Privacy and Security Parameters.....	147
9.2.5.2 Setting the WLAN/LAN Parameters.....	150
9.2.5.3 Setting RS485 Communication Parameters.....	152
9.2.6 Setting Up the RS485 Parallel System.....	152
9.2.7 Quick System Setup.....	153
9.2.7.1 Quick System Setup (Type I).....	155
9.2.8 Setting the Basic Information.....	159
9.2.8.1 Setting up Lightning Protection Alarm Function.....	160
9.2.8.2 Setting Backup Power Parameters.....	160
9.2.8.3 Setting up Shadow Scanning Function.....	162
9.2.8.4 Setting Power Adjustment Parameters.....	162
9.2.9 Setting Advanced Parameters.....	165
9.2.9.1 Setting DRED/Remote Shutdown/RCR/EnWG 14a Function.....	165
9.2.9.2 Setting BACK- UP N and PE Relay Switches.....	166
9.2.9.3 Setting the On-Grid Power Limit.....	167
9.2.9.3.1 Setting the On-Grid Power Limit (General).....	167
9.2.9.3.2 Setting the On-Grid Power Limit (Australia).....	168
9.2.9.4 Setting the AFCI Function.....	170
9.2.9.5 Set Battery Function.....	170

9.2.9.5.1 Setting the Lithium Battery Parameters	170
9.2.9.6 Setting PV Connect Mode	174
9.2.10 Setting Customized Safety Parameters	175
9.2.10.1 Setting Reactive Curve	176
9.2.10.2 Setting Active Curve	180
9.2.10.3 Setting Grid Protection Parameters	187
9.2.10.4 Setting Grid Connection Parameters	188
9.2.10.5 Setting Voltage Fault Ride through Parameters	190
9.2.10.6 Setting Frequency Fault Ride through Parameters	191
9.2.11 Exporting Parameters	192
9.2.11.1 Exporting Safety Parameters	192
9.2.11.2 Exporting Log Parameters	192
9.2.12 Setting Smart Meter Parameters	193
9.2.12.1 Binding/Unbinding Smart Meter	193
9.2.12.2 Meter/ CT Assisted Test	195
9.2.13 Setting Generator/Load Control Parameters	195
9.2.13.1 Setting Load Control Parameters	196
9.2.13.2 Setting Generator Parameters	198
9.2.13.3 Setting Microgrid Parameters	201
9.2.14 Equipment Maintenance	203
9.2.14.1 View Firmware Information/Firmware Upgrade	203
9.2.14.1.1 Regular Firmware Upgrades	203

9.2.14.1.2 One-click Firmware Upgrade	204
9.2.14.1.3 Automatic Firmware Upgrade	205
9.2.14.2 Changing Login Password	205
10 Power Plant Monitoring	208
10.1 APP Introduction	208
10.1.1 Complementary Products	208
10.1.2 Downloading and Installing the App	208
10.1.3 Connection Method	209
10.1.4 Setting Language and Server	209
10.1.5 Setting Communication Parameters	210
10.2 Account Management	210
10.2.1 Registering	210
10.2.2 Account Login	211
10.2.3 Account Switch	212
10.2.4 Account Canceling	212
10.2.5 Account Permissions	213
10.3 Setting Communication Parameters	217
10.3.1 Setting Communication Parameters via Bluetooth	217
10.3.2 Setting Communication Parameters via WiFi	220
10.4 Viewing Power Plant Information	222
10.4.1 View All Power Plant Overview Information	222
10.4.2 Viewing Monopower Plant Details	224

10.4.2.1 Viewing Power Plant Details (Traditional Mode)	225
10.4.3 Viewing Alarm Information	226
10.4.3.1 Viewing Alarm Information for All Power Plants	226
10.4.3.2 Viewing Alarm Information for the Current Power Plant (Traditional Mode)	227
10.4.3.3 Viewing the Current Device's Alarm Information	228
10.4.4 Viewing Power Plant Report Information	229
10.5 Power Plant Management	231
10.5.1 Power Plant Creation	231
10.5.2 Configuring Power Plant Information	232
10.5.3 Power Plant Visitors Management	233
10.5.4 Power Plant Photos Management	234
10.5.5 Adjusting the Information Displayed on the Power Station Details Page	235
10.5.6 Setting PV Component Layout	236
10.5.7 Deleting Power Plant	237
10.5.8 Collecting Power Plant	238
10.6 Managing the Equipment in the Power Plant	238
10.6.1 Additional Equipment	239
10.6.2 Editing Device Information	240
10.6.3 Deleting Device	241
10.6.4 Upgrading Device Firmware Version	242
10.7 Remote Management Device	243
10.7.1 Setting Energy Storage Inverter Parameters	244

11 System Maintenance	250
11.1 Power Off the System	250
11.2 Removing the Equipment	251
11.3 Disposing of the Equipment	252
11.4 Routine Maintenance	252
11.5 Fault	253
11.5.1 Viewing Fault/Alarms Information	253
11.5.2 Fault Information and Troubleshooting	254
11.5.2.1 Inverter Troubleshooting	256
11.5.2.2 Battery Failure	326
11.5.3 Operation After Fault Clearance	344
11.5.3.1 AFCI Fault Clearance Alarm	344
12 Technical Parameters	346
12.1 Inverter Parameters	346
12.2 Technical Data	364
12.3 Smart Meter Technical Data	367
12.3.1 GMK110	367
12.3.2 GM330	367
12.4 Smart Dongle Technical Parameters	368
12.4.1 WiFi/LAN Kit-20	368
12.4.2 4G Kit- CN-G20	369
13 Appendix	371

13.1 FAQ	371
13.1.1 How to Conduct Auxiliary Detection for Smart Meters/ CT?	371
13.1.2 How to Upgrade the Device Version	371
13.2 Abbreviations	372
13.3 Explanation of Terms	375
13.4 Battery SN Code Meaning	376
13.5 Safety Country	377
13.6 Australia Safety Regulations	381
14 Contact Details	386

# 1 About This Manual

## 1.1 Overview

The energy storage system consists of inverter, battery system, and smart meter. This manual describes the product information, installation, electrical connection, commissioning, troubleshooting and maintenance of the system. Read through this manual before installing and operating the products to understand product safety information and familiarize yourself with functions and features of the product. This manual is subject to update without notice. For more product details and latest documents, visit <https://en.goodwe.com/>.



## 1.2 Applicable Model

The energy storage system consists the following products:

Product Type	Product information	Description
Inverter	GW3K-EHA-G20	Rated output power: 3kW-10kW
	GW3.6K-EHA-G20	
	GW5K-EHA-G20	
	GW6K-EHA-G20	
	GW8K-EHA-G20	
	GW9.999K-EHA-G20	
	GW10K-EHA-G20	
Battery system	GW5.1-BAT-D-G20	Nominal Energy 5.12kWh
	GW5.1-BAT-D-G21	
	GW8.3-BAT-D-G20	Nominal Energy 8.32kWh
	GW8.3-BAT-D-G21	
Smart Meter	GMK110	Monitors and detects running data in the energy storage system, such as voltage, current, etc.
	GM330	

Product Type	Product information	Description
Communication Module	WiFi/LAN Kit-20	System operation information can be uploaded to monitoring platform through WiFi or LAN signals.
	4G Kit-CN-G20 (Only for China)	System operation information can be uploaded to monitoring platform through 4G signals.

### 1.3 Symbol Definition

 <b>DANGER</b>
Indicates a high-level hazard that, if not avoided, will result in death or serious injury.
 <b>WARNING</b>
Indicates a medium-level hazard that, if not avoided, could result in death or serious injury.
 <b>CAUTION</b>
Indicates a low-level hazard that, if not avoided, could result in minor or moderate injury.
<b>NOTICE</b>
Highlights key information and supplements the texts. Or some skills and methods to solve product-related problems to save time.

## 2 Safety Precautions

Please strictly follow these safety instructions in the user manual during the operation.

### WARNING

The products are designed and tested strictly to comply with related safety rules. Follow all the safety instructions and cautions before any operations. Improper operation might cause personal injury or property damage as the products are electrical equipment.

### 2.1 General Safety

#### NOTICE

- The information in this document is subject to change due to product updates or other reasons. This document cannot replace the product labels or the safety precautions unless otherwise specified. All descriptions in the manual are for guidance only.
- Before installations, read through the user manual to learn about the product and the precautions.
- All operations should be performed by trained and knowledgeable technicians who are familiar with local standards and safety regulations.
- Use insulating tools and wear personal protective equipment when operating the equipment to ensure personal safety. Wear anti-static gloves, wrist strips, and cloths when touching electronic devices to protect the equipment from damage.
- Unauthorized dismantling or modification may damage the equipment, and the damage is not covered under the warranty.
- Strictly follow the installation, operation, and configuration instructions in this manual or the user manual. The manufacturer shall not be liable for equipment damage or personal injury if you do not follow the instructions. For more warranty details, please visit <https://www.goodwe.com/warrantyrelated.html>.

### 2.2 Personal Requirements

## NOTICE

- Personnel who install or maintain the equipment must be strictly trained, learn about safety precautions and correct operations.
- Only qualified professionals or trained personnel are allowed to install, operate, maintain, and replace the equipment or parts.

## 2.3 System Safety

### DANGER

- Disconnect the upstream switches to power off the equipment before any electrical connections. Do not work with power on. Otherwise, an electric shock may occur.
- Install a breaker at the voltage input side of the equipment to prevent personal injury or equipment damage caused by energized electrical work.
- All operations such as transportation, storage, installation, use and maintenance shall comply with applicable laws, regulations, standards and specifications.
- Perform electrical connections in compliance with local laws, regulations, standards and specifications, including cables and component specifications.
- Use the connectors included in the package to connect cables. The manufacturer shall not be liable for the equipment damage if connectors of other models are used.
- Ensure all cables are connected correctly, tightly, and securely. Inappropriate wiring may cause poor connection and damage the equipment.
- The PE cables must be connected and secured properly.
- To protect the equipment and components from damage during transportation, ensure that the transportation personnel are professionally trained. All operations during the transportation have to be recorded. The equipment shall be kept in balance to avoid falling down.
- The equipment is heavy. Please equip the corresponding personnel according to its weight, so that the equipment does not exceed the maximum weight that the personnel can carry to avoid personnel injuries.
- Keep the equipment stable to avoid dumping, which can result in equipment damage and personal injuries.

 **WARNING**

- Do not apply mechanical load to terminals, otherwise the terminals may be damaged.
- If the cable bears too much tension, the connection may be poor. Reserve a certain length of the cable before connecting it to corresponding ports.
- Tie the cables of the same type together, and place cables of different types at least 30mm apart. Do not place the cables entangled or crossed.
- Place the cables at least 30mm away from the heating components or heat sources, otherwise the insulation layer of the cables may be aging or broken due to high temperature.

### 2.3.1 PV String Safety

 **WARNING**

- Ensure the PV module frames and the bracket system are securely grounded.
- Ensure the DC cables are connected tightly, securely and correctly. Inappropriate wiring may cause poor contacts or high impedances, and damage the inverter.
- Measure the positive and negative terminals of the DC cable using a multimeter to avoid reverse polarity connection. Also, the voltage should be within the permissible range.
- Measure the DC cable using the multimeter to avoid reverse polarity connection. Also, the voltage should be under the max DC input voltage. The manufacturer shall not be liable for the damage caused by reverse connection and extremely high voltage.
- The PV strings cannot be grounded. Ensure the minimum insulation resistance of PV string to the ground meets the minimum insulation resistance requirements before connecting the PV string to the inverter ( $R = \text{maximum input voltage (V)} / 30\text{mA}$ ).
- Do not connect the same PV string to multiple inverters at the same time. Otherwise, the inverters may be damaged.
- PV modules used with inverters must comply with IEC 61730 Class A standard.

### 2.3.2 Inverter Safety

 WARNING

- The voltage and frequency at the connecting point should meet the on-grid requirements.
- Additional protective devices like circuit breakers or fuses are recommended on the AC side. Specification of the protective device should be at least 1.25 times the maximum AC output current.
- The arc fault alarms will be cleared automatically if the alarms are triggered less than 5 times in 24 hours. The inverter will shutdown for protection after the 5th electric arc fault. The inverter can operate normally after the fault is solved.
- BACK-UP is not recommended if the PV system is not configured with batteries. Otherwise, there may be a risk of system power outage.

### 2.3.3 Battery Safety

 DANGER

- Keep Power Off before any operations to avoid danger of electric shock. Strictly follow all safety precautions outlined in this manual and safety labels on the equipment during the operation.
- Do not disassemble, modify, or replace any part of the battery without official authorization from the manufacturer. Otherwise, it will cause electrical shock or damages to the equipment, which shall not be borne by the manufacturer.
- Do not hit, pull, drag, squeeze or step on the equipment or put the battery into fire. Otherwise, the battery may explode.
- Do not place the battery in a high temperature environment. Make sure that there is no direct sunlight and no heat source near the battery. When the ambient temperature exceeds 60 °C, it will cause fire.
- Do not use the battery if it is defective, broken, or damaged. Damaged battery may leak electrolyte.
- Do not move the battery system while it is working. Contact after-sales service if the battery shall be replaced or added.
- A short circuit in the battery may cause personal injury. The instantaneous high current caused by a short circuit can release a large amount of energy and may cause a fire.
- To protect the equipment and components from damage during transportation, ensure that the transportation personnel are professionally trained. All operations during the transportation have to be recorded. The equipment shall be kept in balance to avoid falling down.
- Battery The equipment is heavy. Please equip the corresponding personnel according to its weight, so that the equipment does not exceed the maximum weight that the personnel can carry to avoid personnel injuries.

 WARNING

- Factors such as temperature, humidity, weather conditions, etc. may limit the battery's current and affect its load.
- Contact after-sale service immediately if the battery is not able to be started. Otherwise, the battery might be damaged permanently.
- Inspect and maintain the battery regularly according to the maintenance requirements of the battery.
- Ensure that the battery system is not damaged during transportation and storage. Keep the equipment stable to avoid dumping, which can result in equipment damage and personal injuries.

## Emergency Measures

- Battery Electrolyte Leakage

If the battery module leaks electrolyte, avoid contact with the leaking liquid or gas. The electrolyte is corrosive. It will cause skin irritation or chemical burn to the operator. Anyone contact the leaked substance accidentally has to act/respond as following:

- Breath in the leaked substance: Evacuate from the polluted area, and seek immediate medical assistance.
- Eye contact: Rinse your eyes for at least 15 minutes with clean water and seek immediate medical assistance.
- Skin contact: Thoroughly wash the touch area with soap and clean water, and seek immediate medical assistance.
- Ingestion: Induce vomiting, and seek immediate medical assistance.
- Fire
  - The battery may burn when the ambient temperature exceeds 150°C. Poisonous and hazardous gas may be released if the battery is on fire.
  - In the event of a fire, please make sure that the carbon dioxide extinguisher or water extinguishing device is nearby.
  - The fire cannot be put out by ABC dry powder extinguisher. Firefighters are required to wear full protective clothing and self-contained breathing apparatus.
- Battery triggers fire protection
 

For batteries with fire protection functions, perform the following operations after the fire protection function is triggered:

  - Immediately cut off the main power switch to ensure that no current passes through the battery system.
  - Conduct a preliminary inspection of the appearance of the battery to determine

if there is any damage, deformation, leakage, or odor. Check the battery casing, connectors, and cables.

- Use temperature sensors to detect the temperature of the battery and its environment, ensuring there is no risk of overheating.
- Isolate and label damaged batteries, and handle them properly in accordance with local regulations.

### 2.3.4 Smart Meter Safety



#### WARNING











If the voltage of the power grid fluctuates, resulting in the voltage over 265V. In this case, long-term overvoltage operation may cause damage to the meter. It is recommended to add a fuse with a rated current of 0.5A on the voltage input side of the meter to protect it.





## 2.4 Safety Symbols and Certification Marks

#### DANGER

- All labels and warning marks should be visible after the installation. Do not cover, scrawl, or damage any label on the equipment.
- The following descriptions are for reference only. Please refer to the actual labeling of the equipment.

No.	Symbol	Descriptions
1		Potential risks exist. Wear proper PPE before any operations.
2		High voltage hazard. High voltage exists. Disconnect all incoming power and turn off the product before working on it.
3		High-temperature hazard. Do not touch the product under operation to avoid being burnt.

No.	Symbol	Descriptions
4		Operate the equipment properly to avoid explosion.
5		Batteries contain flammable materials, beware of fire.
6		The equipment contains corrosive electrolytes. In case of a leak in the equipment, avoid contacting the leaked liquid or gas.
7		Delayed discharge. Wait 5 minutes after power off until the components are completely discharged.
8		Install the equipment away from fire sources.
9		Keep away from children.
10		Do not pour with water.
11		Read through the user manual before any operations.
12		Wear PPE during installation, operation and maintaining.
13		Do not dispose of the System as household waste. Deal with it in compliance with local laws and regulations, or send it back to the manufacturer.
14		Grounding point.

No.	Symbol	Descriptions
15		Recycle regeneration mark.
16		CE Mark.
17		TUV mark.
18		RCM mark.

## 2.5 EU Declaration of Conformity

### 2.5.1 Equipment with Wireless Communication Modules

The equipment with wireless communication modules sold in the European market meets the requirements of the following directives:

- Radio Equipment Directive 2014/53/EU (RED)
- Restrictions of Hazardous Substances Directive 2011/65/EU and (EU) 2015/863 (RoHS)
- Waste Electrical and Electronic Equipment 2012/19/EU
- Registration, Evaluation, Authorization and Restriction of Chemicals (EC) No 1907/2006 (REACH)

### 2.5.2 Equipment without Wireless Communication Modules (Except Battery)

The equipment without wireless communication modules sold in the European market meets the requirements of the following directives:

- Electromagnetic compatibility Directive 2014/30/EU (EMC)
- Electrical Apparatus Low Voltage Directive 2014/35/EU (LVD)
- Restrictions of Hazardous Substances Directive 2011/65/EU and (EU) 2015/863 (RoHS)

- Waste Electrical and Electronic Equipment 2012/19/EU
- Registration, Evaluation, Authorization and Restriction of Chemicals (EC) No 1907/2006 (REACH)

### **2.5.3 Battery**

The batteries sold in the European market meets the requirements of the following directives:

- Electromagnetic compatibility Directive 2014/30/EU (EMC)
- Electrical Apparatus Low Voltage Directive 2014/35/EU (LVD)
- Battery Directive 2006/66/EC and Amending Directive 2013/56/EU
- Waste Electrical and Electronic Equipment 2012/19/EU
- Registration, Evaluation, Authorization and Restriction of Chemicals (EC) No 1907/2006 (REACH)

You can download the EU Declaration of Conformity from our official website at:  
<https://en.goodwe.com>.

## 3 System Introduction

### 3.1 System Overview

Residential all-in-one energy storage system solution consists of inverter, battery system, smart meter, smart dongle, etc. In the PV system, solar energy can be converted to electric energy for household needs. The Software & Accessories in the system controls the electrical equipment by recognizing the overall power consumption situation. So that the power will be managed in a smart way, deciding whether the power is to be used by the loads, stored in batteries, or exported to the grid, etc.

#### WARNING

- If the system is in a high temperature or BMS current limiting situation, it may cause the battery charging power to be limited, which may lead to high system voltage triggering over-voltage protection.
- In microgrid scenarios, the PV open-circuit voltage of the residential all-in-one energy storage system is recommended to be < 500V to avoid the system voltage becoming too high and triggering overvoltage protection under adverse conditions.
- In microgrid scenarios, make sure that the overfrequency derating point of the on-grid inverter is the same as that of the residential all-in-one energy storage system.
- If output power limitation is required for the on-grid inverter, please connect a separate device such as a smart meter or CT.
- Make sure that the overfrequency derating curve of the on-grid inverter is set according to the following via SolarGo:
  - Set the End Power to 0% P<sub>n</sub>
  - Set the response delay time to 0, and disable the hysteresis function
- Due to product upgrades or other reasons, the document content may be updated irregularly. The matching relationship between inverters and Software & Accessories products can refer to:  
[https://en.goodwe.com/Ftp/EN/Downloads/User%20Manual/GW\\_Compatibility-list-of-GoodWe-inverters-and-IoT-products-EN.pdf](https://en.goodwe.com/Ftp/EN/Downloads/User%20Manual/GW_Compatibility-list-of-GoodWe-inverters-and-IoT-products-EN.pdf)
- For the detailed network configuration and wiring schemes for various scenarios, please refer to: [6.2.System Wiring Detail Diagram\(Page 79\)](#).

When the energy storage system is in the off-grid state, the following loads can be used normally:

<b>Description for Off-Grid Load-Carrying Capacity of the Inverter</b>	
Load Type	ESA 3-10kW
Rated Power of Single Generator Load (kVA)	$0.3 \cdot P_n$
Total Rated Power of Generator Loads (kVA)	$0.3 \cdot P_n$
Capacitive Load (kVA)	$0.33 \cdot P_n$
<p>Note:</p> <ul style="list-style-type: none"> <li>• <math>P_n</math>: Rated Output Power of the inverter.</li> <li>• For 2 or more units operating in parallel, the allowable total generator load nominal power = Single generator load nominal power * Number of parallel units * 80%.</li> <li>• Half-wave Load: Some older or non-EMC-compliant appliances (such as hair dryers or small heaters using half-wave rectification) .</li> </ul>	

## General Scenarios

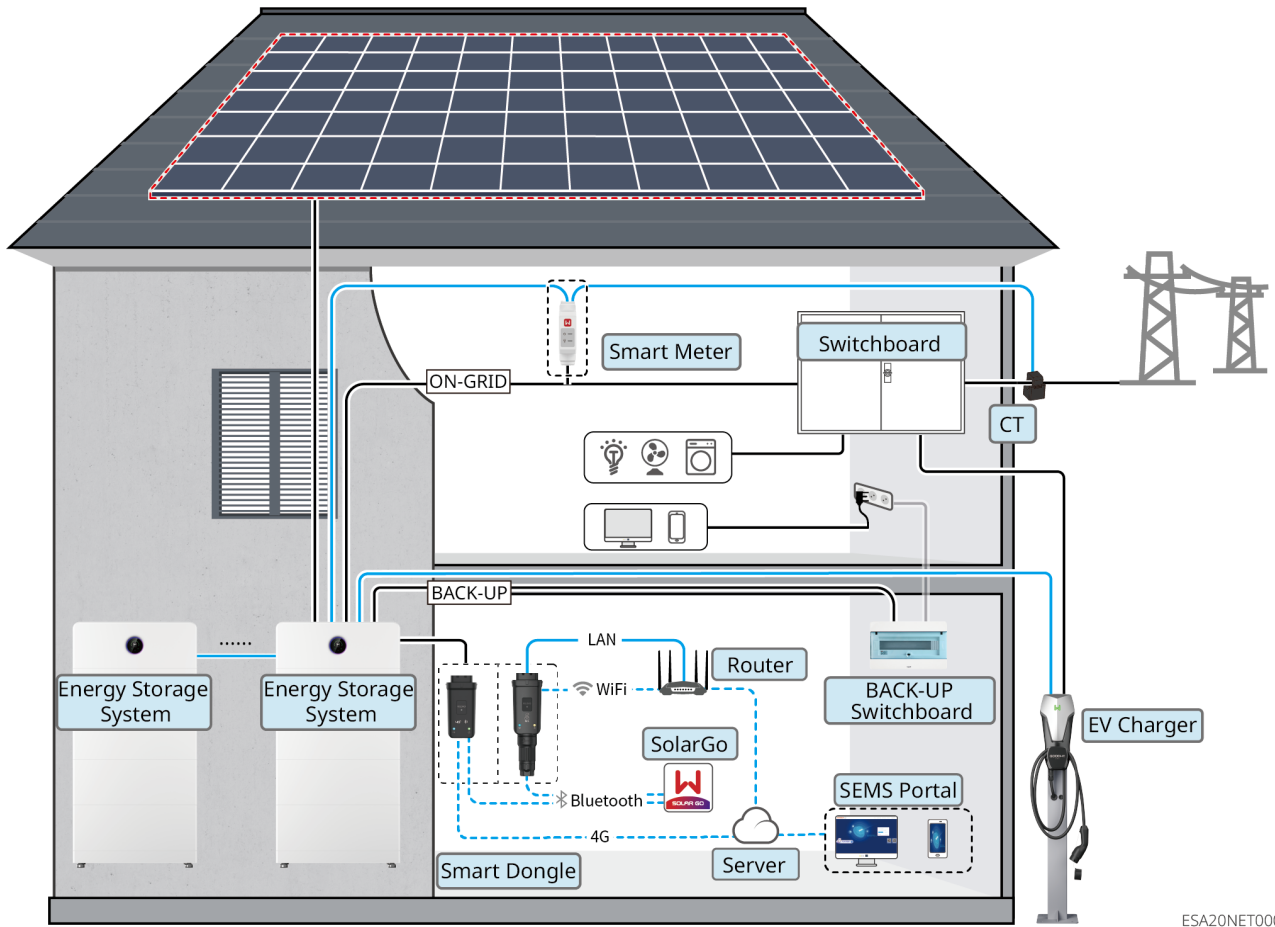

ESA20NET001

Product Type	Model	Discription
Energy Storage Inverter	GW3K-EHA-G20	
	GW3.6K-EHA-G20	
	GW5K-EHA-G20	
	GW6K-EHA-G20	
	GW8K-EHA-G20	
	GW9.999K-EHA-G20	

Product Type	Model	Discription
	GW10K-EHA-G20	<ul style="list-style-type: none"> <li>• Compatible with GoodWe AC charging stations.</li> <li>• Generator control and generator-to-battery charging are only supported in the single inverter scenario.</li> <li>• The system supports a maximum of 6 inverters to form a parallel system, and enables on/off-grid hybrid parallel inverters with different power ranges.</li> <li>• In a parallel system, if the GW3K/3.6K/5K/6K models are mixed with the GW8K/9.999K/10K models, please set the GW8K/9.999K/10K model as the master inverter.</li> <li>• If it is necessary to connect a generator or build a parallel system, please use the GMK110 or GM330 smart meter; if the number of parallel inverters exceeds 2, please use the GM330 smart meter.</li> <li>• In a parallel system, each inverter must be equipped with a WiFi/LAN Kit-20. The software version requirements are V2.5 or above.</li> <li>• Requirements for parallel system: <ul style="list-style-type: none"> <li>◦ The ARM software version of the inverter is 02.99 and above.</li> <li>◦ The DSP software version of the inverter is 02.2024 and above.</li> <li>◦ The SolarGo software version is 6.8.0 and above.</li> </ul> </li> </ul>
Battery System	GW5.1-BAT-D-G20	
	GW5.1-BAT-D-G21	
	GW8.3-BAT-D-G20	

Product Type	Model	Discription
	GW8.3-BAT-D-G21	<ul style="list-style-type: none"> <li>• Battery of different models can be mixed for use. It meets the requirements of matching use with different powers and capacities.</li> <li>• The maximum available power of a single cluster is 48kWh.</li> <li>• When GW5.1-BAT-D-G20 and GW8.3-BAT-D-G20 are mixed with GW5.1-BAT-D-G21 and GW8.3-BAT-D-G21, the running ambient temperature requirements shall be based on those of GW5.1-BAT-D-G21 and GW8.3-BAT-D-G21.</li> </ul>
Smart Meter	Built-in Smart Meter (shipped with inverter)	<ul style="list-style-type: none"> <li>• Built-in Smart Meter: Connect the inverter using the delivered CT.               <ul style="list-style-type: none"> <li>◦ The default CT ratio is 120A : 40mA.</li> <li>◦ When the built-in smart meter of the inverter fails to meet usage requirements, contact the dealers to purchase the GMK110 or GM330 smart meter.</li> </ul> </li> <li>• GMK110: It is not supported to change the CT to other type, CT ratio is 120A: 40mA.</li> <li>• GM330: CTs are supported to be sourced either from GoodWe or purchased independently, the default CT ratio is nA : 5A.</li> <li>• If the inverter need to connect a generator, please use the GMK110 or GM330 smart meter.</li> </ul>
	GMK110 (purchase from GoodWe)	
	GM330 (purchase from GoodWe)	

Product Type	Model	Discription
Smart Dongle	WiFi/LAN Kit-20	<ul style="list-style-type: none"> <li>• Applicable for single inverter scenario and parallel scenario.</li> <li>• Device parameters can be configured and device operating information can be viewed locally via Bluetooth signals, while system operating information can be uploaded to the monitoring platform via WiFi or LAN.</li> <li>• If the functions such as one-click upgrade and operation log export are required, please ensure that the software version of WiFi/LAN Kit-20 is V2.3 or above.</li> </ul>
	4G Kit-CN-G20 (Only for China)	<ul style="list-style-type: none"> <li>• Only applicable for single inverter scenario.</li> <li>• Device parameters can be configured and device operation information can be viewed locally via Bluetooth signals, while system operation information can be uploaded to monitoring platform through 4G signals.</li> <li>• If the functions such as one-click upgrade and operation log export are required, please ensure that the software version of 4G Kit-CN-G20 is 05 or above.</li> </ul>

### Microgrid Scenarios

When the grid-tied inverter is connected to the BACK- UP port of the hybrid inverter, it is a microgrid scenarios.

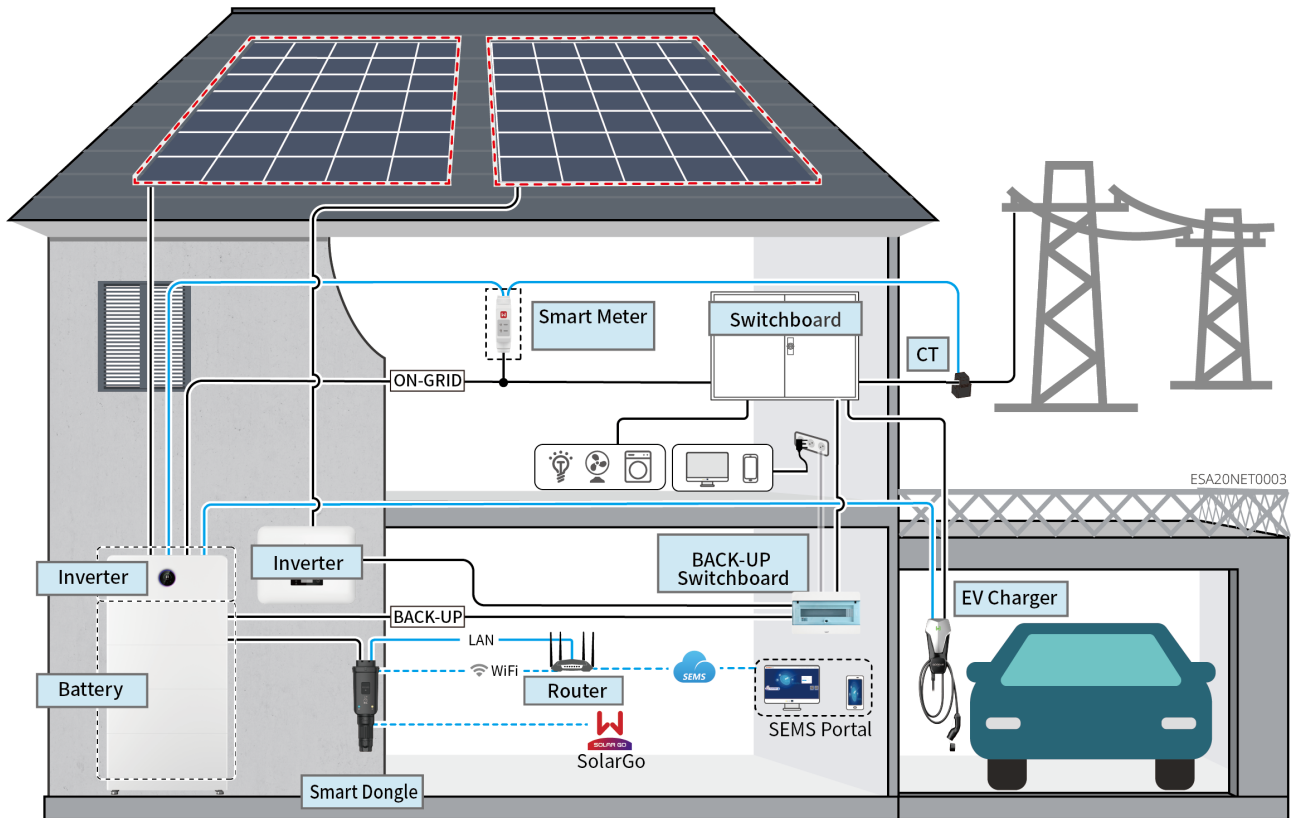

Product Type	Model	Discription
Energy Storage Inverter	GW3K-EHA-G20	<ul style="list-style-type: none"> <li>• In microgrid scenarios, only one energy storage inverter is supported for use in the system.</li> <li>• In microgrid scenarios, connection to a generator is not supported.</li> </ul>
	GW3.6K-EHA-G20	
	GW5K-EHA-G20	
	GW6K-EHA-G20	
	GW8K-EHA-G20	
	GW9.999K-EHA-G20	
	GW10K-EHA-G20	
Battery System	GW5.1-BAT-D-G20	
	GW5.1-BAT-D-G21	
	GW8.3-BAT-D-G20	

Product Type	Model	Discription
	GW8.3-BAT-D-G21	<ul style="list-style-type: none"> <li>• Battery of different models can be mixed for use. It meets the requirements of matching use with different powers and capacities.</li> <li>• The maximum available power of a single cluster is 48kWh.</li> <li>• When GW5.1-BAT-D-G20 and GW8.3-BAT-D-G20 are mixed with GW5.1-BAT-D-G21 and GW8.3-BAT-D-G21, the running ambient temperature requirements shall be based on those of GW5.1-BAT-D-G21 and GW8.3-BAT-D-G21.</li> </ul>
Smart Meter	Built-in Smart Meter (shipped with inverter)	<ul style="list-style-type: none"> <li>• Built-in Smart Meter: Connect the inverter using the delivered CT.               <ul style="list-style-type: none"> <li>◦ The default CT ratio is 120A : 40mA</li> <li>◦ When the built-in smart meter of the inverter fails to meet usage requirements, contact the dealers to purchase the GMK110 or GM330 smart meter.</li> </ul> </li> <li>• GMK110: It is not supported to change the CT to other type, CT ratio is 120A: 40mA.</li> <li>• GM330: CTs are supported to be sourced either from GoodWe or purchased independently, CT turns ratio requirement: nA : 5A</li> </ul>
	GMK110 (purchase from GoodWe)	
	GM330 (purchase from GoodWe)	

Product Type	Model	Discription
Smart Dongle	WiFi/LAN Kit-20	<ul style="list-style-type: none"> <li>• Applicable for single inverter scenario and parallel scenario.</li> <li>• Device parameters can be configured and device operating information can be viewed locally via Bluetooth signals, while system operating information can be uploaded to the monitoring platform via WiFi or LAN.</li> <li>• If the functions such as one-click upgrade and operation log export are required, please ensure that the software version of WiFi/LAN Kit-20 is V2.3 or above.</li> </ul>
	4G Kit-CN-G20 (Only for China)	<ul style="list-style-type: none"> <li>• Only applicable for single inverter scenario.</li> <li>• Device parameters can be configured and device operation information can be viewed locally via Bluetooth signals, while system operation information can be uploaded to monitoring platform through 4G signals.</li> <li>• If the functions such as one-click upgrade and operation log export are required, please ensure that the software version of 4G Kit-CN-G20 is 05 or above.</li> </ul>

Product Type	Model	Discription
On-Grid Inverter	-	<ul style="list-style-type: none"> <li>• It's recommended to use on-grid inverter sold in GOODWE, and is supported to use the third-party on-grid inverter.</li> <li>• In microgrid scenarios, make sure that the nominal output power of the on-grid inverter is <math>&lt; =</math> the nominal output power of the hybrid inverter.</li> <li>• When the microgrid system is grid connected, if power limit is required, make sure: <ul style="list-style-type: none"> <li>◦ The hybrid inverter should be set in the power limit interface of the SolarGo APP, and the on-grid inverter should be set according to the actual tools used.</li> <li>◦ In order to ensure that the on-grid inverters can continue to generate power, the output power of the hybrid inverters must be adjusted in the microgrid mode interface of the SolarGo APP.</li> </ul> </li> </ul> <p>Note: The output power control precision of different on-grid inverters varies. Please set the on-grid power limit control parameter value according to the actual situation.</p>

### Coupled Scenario

When the grid-tied inverter is connected to the ON- GRID port of the hybrid inverter, it is a coupled scenario.

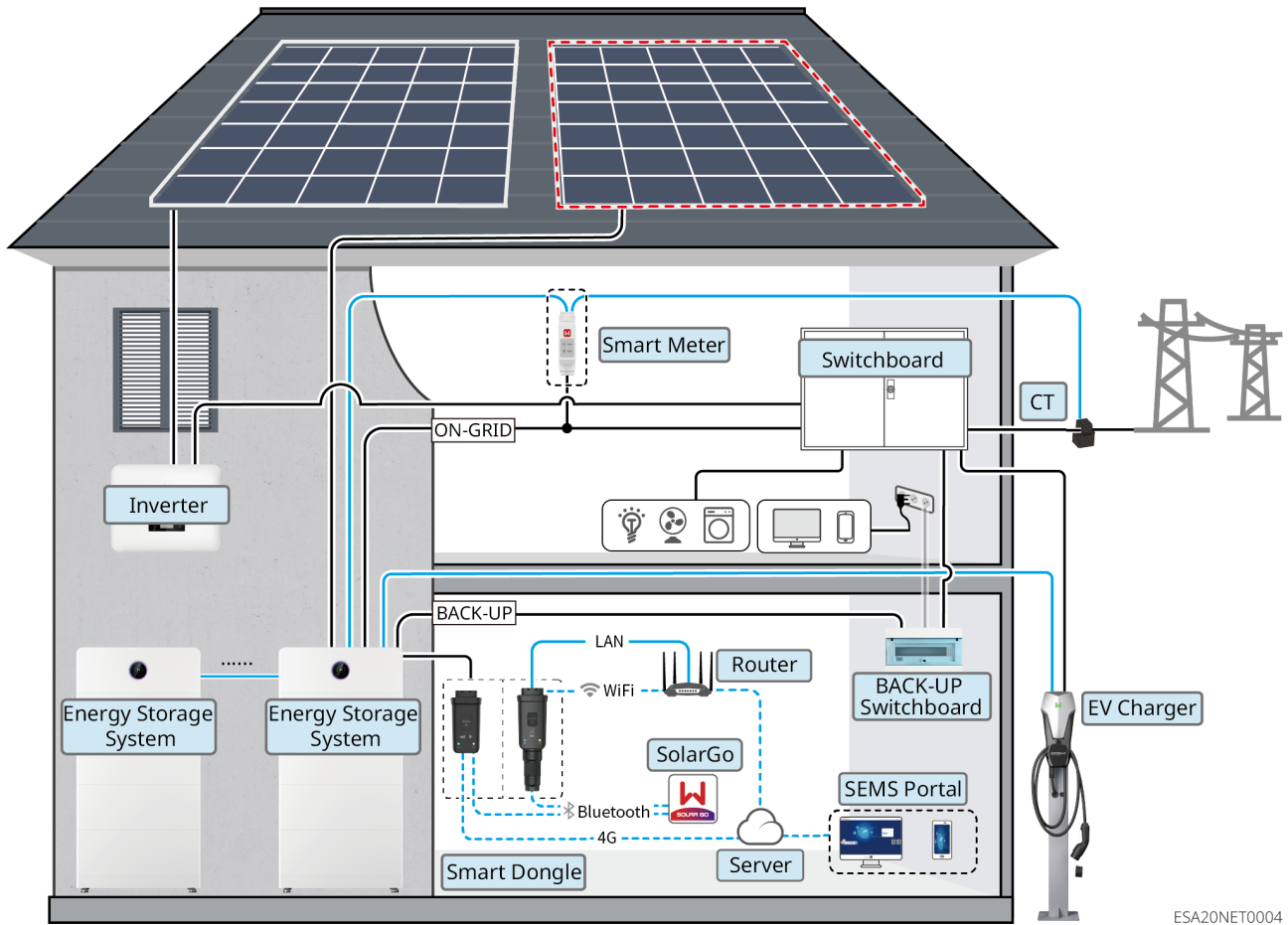

ESA20NET0004

Product Type	Model	Discription
Energy Storage Inverter	GW3K-EHA-G20	
	GW3.6K-EHA-G20	
	GW5K-EHA-G20	
	GW6K-EHA-G20	
	GW8K-EHA-G20	
	GW9.999K-EHA-G20	

Product Type	Model	Description
	GW10K-EHA-G20	<ul style="list-style-type: none"> <li>• Generator control and generator-to-battery charging are only supported in the single inverter scenario.</li> <li>• The system supports a maximum of 6 inverters to form a parallel system, and enables on/off-grid hybrid parallel inverters with different power ranges.</li> <li>• In a parallel system, if the GW3K/3.6K/5K/6K models are mixed with the GW8K/9.999K/10K models, please set the GW8K/9.999K/10K model as the master inverter.</li> <li>• If it is necessary to connect a generator or build a parallel system, please use the GMK110 or GM330 smart meter; if the number of parallel inverters exceeds 2, please use the GM330 smart meter.</li> <li>• In a parallel system, each inverter must be equipped with a WiFi/LAN Kit-20. The software version requirements are V2.5 or above.</li> <li>• The following version requirements must be met when operating in parallel for grid connection: <ul style="list-style-type: none"> <li>◦ The ARM software version of the inverter is 02.99 and above.</li> <li>◦ The DSP software version of the inverter is 02.2024 and above.</li> <li>◦ The SolarGo software version is 6.8.0 and above.</li> </ul> </li> </ul>
Battery System	GW5.1-BAT-D-G20	
	GW5.1-BAT-D-G21	
	GW8.3-BAT-D-G20	

Product Type	Model	Discription
	GW8.3-BAT-D-G21	<ul style="list-style-type: none"> <li>• Battery of different models can be mixed for use. It meets the requirements of matching use with different powers and capacities.</li> <li>• The maximum available power of a single cluster is 48kWh.</li> <li>• When GW5.1-BAT-D-G20 and GW8.3-BAT-D-G20 are mixed with GW5.1-BAT-D-G21 and GW8.3-BAT-D-G21, the running ambient temperature requirements shall be based on those of GW5.1-BAT-D-G21 and GW8.3-BAT-D-G21.</li> </ul>
Smart Meter	Built-in Smart Meter (shipped with inverter)	<ul style="list-style-type: none"> <li>• Built-in Smart Meter: Connect the inverter using the delivered CT.               <ul style="list-style-type: none"> <li>◦ The default CT ratio is 120A : 40mA</li> <li>◦ When the built-in smart meter of the inverter fails to meet usage requirements, contact the dealers to purchase the GMK110 or GM330 smart meter.</li> </ul> </li> <li>• GMK110: It is not supported to change the CT to other type, the default CT ratio is 120A : 40mA.</li> <li>• GM330: CTs are supported to be sourced either from GoodWe or purchased independently, the default CT ratio is nA : 5A.</li> <li>• If the inverter need to connect a generator, please use the GMK110 or GM330 smart meter.</li> </ul>
	GMK110 (purchase from GoodWe)	
	GM330 (purchase from GoodWe)	

Product Type	Model	Description
Smart Dongle	WiFi/LAN Kit-20	<ul style="list-style-type: none"> <li>• Applicable for single inverter scenario and parallel scenario.</li> <li>• Device parameters can be configured and device operating information can be viewed locally via Bluetooth signals, while system operating information can be uploaded to the monitoring platform via WiFi or LAN.</li> <li>• If the functions such as one-click upgrade and operation log export are required, please ensure that the software version of WiFi/LAN Kit-20 is V2.3 or above.</li> </ul>
	4G Kit-CN-G20 (Only for China)	<ul style="list-style-type: none"> <li>• Only applicable for single inverter scenario.</li> <li>• Device parameters can be configured and device operation information can be viewed locally via Bluetooth signals, while system operation information can be uploaded to monitoring platform through 4G signals.</li> <li>• If the functions such as one-click upgrade and operation log export are required, please ensure that the software version of 4G Kit-CN-G20 is 05 or above.</li> </ul>

Product Type	Model	Discription
On-Grid Inverter	-	<ul style="list-style-type: none"> <li>• It's recommended to use on-grid inverter sold in GOODWE, and is supported to use the third-party on-grid inverter.</li> <li>• In AC coupled scenarios, make sure that the nominal output power of the on-grid inverter is <math>&lt; =</math> the nominal output power of the hybrid inverter.</li> <li>• When the coupled system is in on-grid mode, If power limitation control is required, the hybrid inverter should be set in the export power limit interface of the SolarGo APP, and the on-grid inverter should be set according to the actual tools used.</li> </ul> <p>Note: The output power control precision of different on-grid inverters varies. Please set the on-grid power limit control parameter value according to the actual situation.</p>

## 3.2 Product Overview

### 3.2.1 Residential All-In-One Energy Storage System (Single Phase)

#### **Residential All-In-One Energy Storage System (Single Phase):**

Residential All-In-One Energy Storage System (Single Phase), which integrates batteries and inverters through modular design and adopts a blind plug stacking connection method.

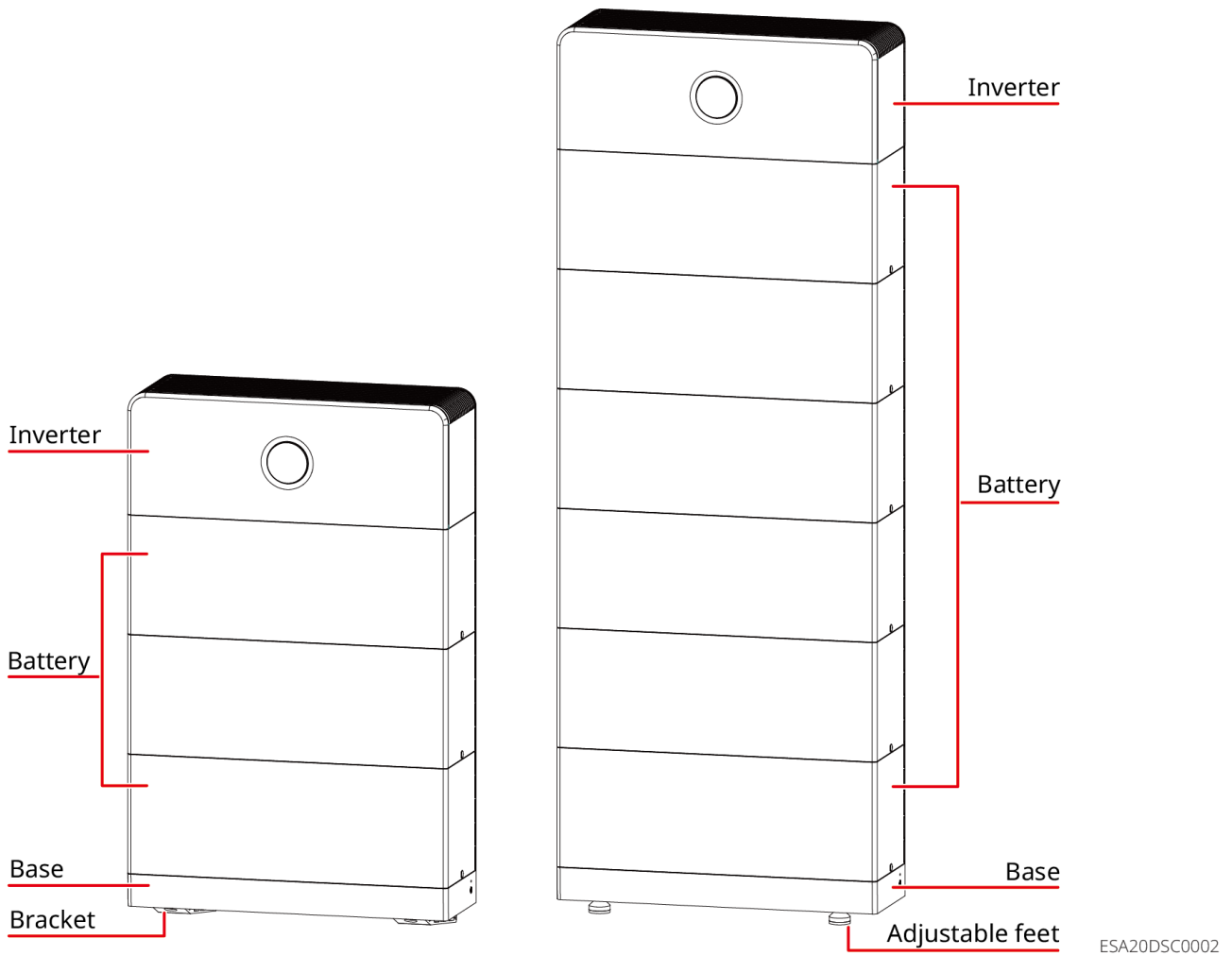

ESA20DSC0002

### Floor-mounted installation

Ground installation supports stacking up to 6 batteries.

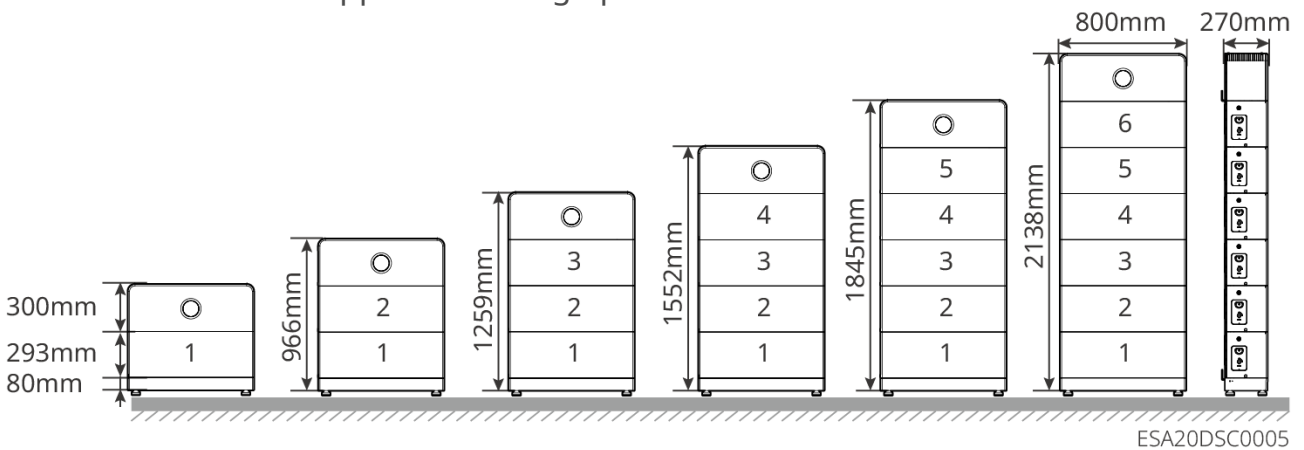

### Wall-mounted Installation

The maximum quantity of stacked units for wall-mounted installation is as follows:

A: GW5.1-BAT-D-G20    B: GW8.3-BAT-D-G20  
 GW5.1-BAT-D-G21    GW8.3-BAT-D-G21

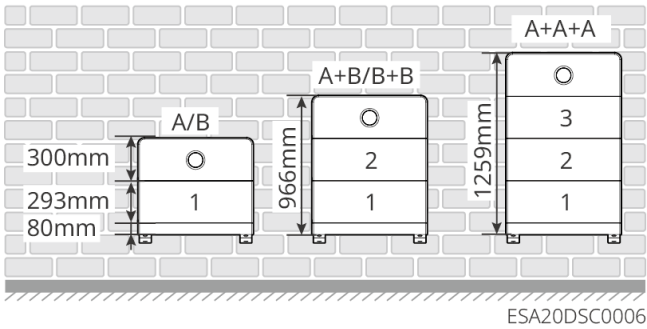

**Inverter:**

Inverters control and optimize the power in PV systems through an integrated energy management system. The electricity generated in the photovoltaic system can be used for loads, stored in batteries, output to the power grid, etc.

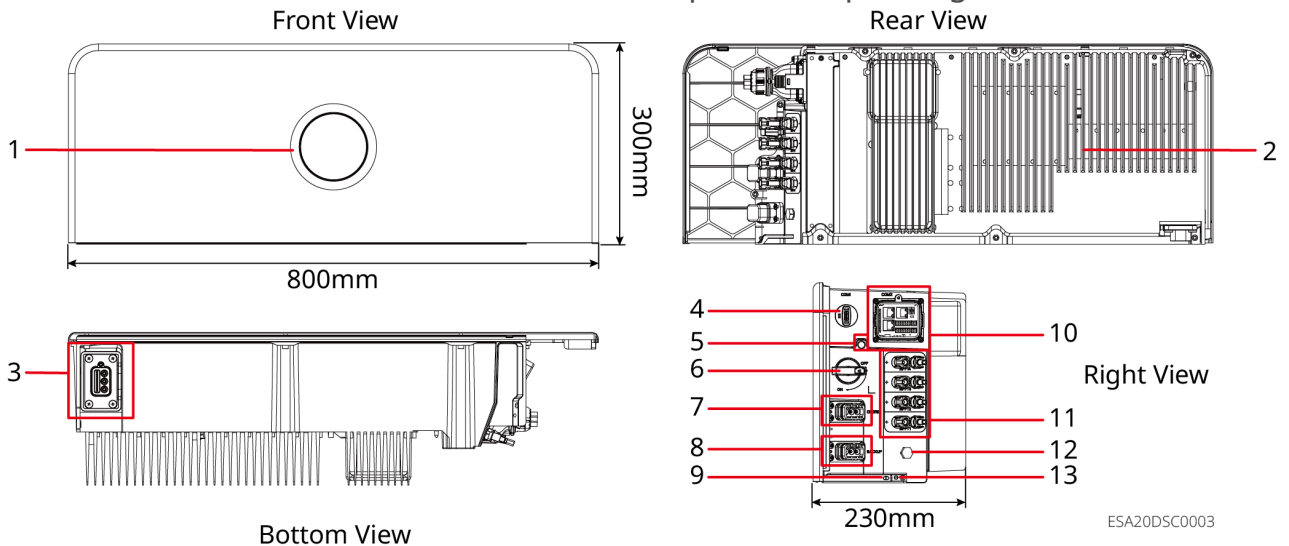

No.	Components / Silk Screen Printing	Description
1	Indicator	Indicating the working status of the inverter and the SOC of the battery.
2	Heat Sink	Uses for heat dissipation of the inverter.
3	Connector	Power and Communication Ports for Inverter-Battery Connection.

No.	Components / Silk Screen Printing	Description
4	Smart Dongle Port	<ul style="list-style-type: none"> <li>Connecting the Smart Dongle, such as WiFi/LAN Kit-20 or 4G Kit-CN-G20 and select the type of the Smart Dongle according to actual needs.</li> <li>Supporting connection with USB flash drive for local software upgrading.</li> </ul>
5	Lifting Rod Mounting Hole	(Optional) Used to install lifting rod. Used when handling inverters.
6	DC Switch	Controlling the connection or disconnection of DC input.
7	ON-GRID Port	Connecting the AC cables and connect the inverter to the utility grid.
8	BACK-UP Port	Connecting the AC cables and connect important loads or on-grid inverter.
9	Battery Mounting Holes	Secure the inverter and battery
10	Communication Port	Connecting communication cables for load control, CT, RS485, remote shutdown/rapid shutdown, DRED (Australia) /RCR (Europe) etc.
11	PV Input Terminal	<p>Used to connect the PV module DC input cables. PV Input Terminal Quantity:</p> <ul style="list-style-type: none"> <li>GW3K-EHA-G20, GW3.6K-EHA-G20, GW5K-EHA-G20, GW6K-EHA-G20 : 2</li> <li>GW8K-EHA-G20, GW9.999K, EHA-G20, GW10K-EHA-G20: 4</li> </ul>
12	Ventilation valve	-

No.	Components / Silk Screen Printing	Description
13	Protective Grounding Terminal	Connects the grounding cable of the inverter.

**Batteries:**

The battery system stores and releases electricity based on the requirements of a PV energy storage system. The input and output ports of the energy storage system are both high-voltage direct current.

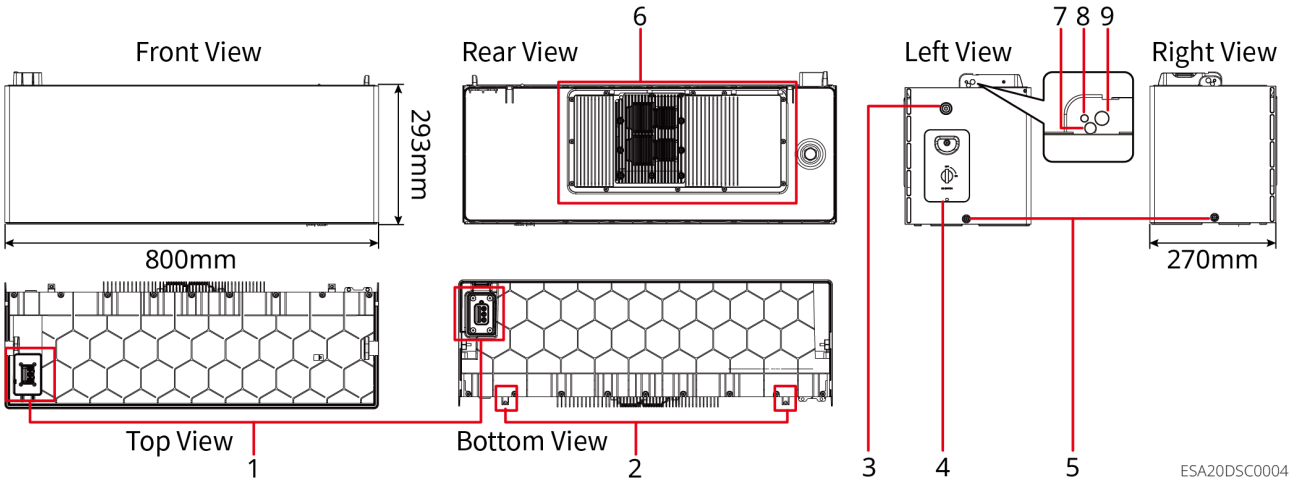

ESA20DSC0004

No.	Component	Description
1	Connector	Power and Communication Ports for Battery-Battery and Inverter-Battery Connection.
2	Anti-tip Bracket Fixing Hole	Used for securing the battery to the wall.

No.	Component	Description
3	Multi-function Button Indicator Light	<ul style="list-style-type: none"> <li>• Indicator STS work state.</li> <li>• Battery black start function: When there is no PV power generation in the photovoltaic system and the grid is abnormal, if the inverter cannot operate normally, the battery black start function can be used to force the battery to discharge and start the inverter. The inverter can then enter off-grid mode and operate, with the battery supplying power to the load.</li> <li>• Battery Power-Off Function: Press and hold the multi-function button for more than 5 seconds to power off the battery system.</li> </ul>
4	Battery Isolator Switch	Battery Power Input/Output Switch
5	Battery Mounting Holes	Used for securing two batteries together.
6	Heat Sink	Battery Heating
7	Battery Lifting Hole	Used for installing batteries. When stacking more than three batteries, a hoisting tool must be used for hoisting and installation.
8	Battery/Inverter Mounting Holes	Battery/Inverter Mounting Holes
9	Lifting Rod Mounting Hole	(Optional) Used to install lifting rod. Used when handling inverters.

### 3.2.2 Smart Meter

The smart meter can measure and monitor the data in the photovoltaic energy storage system, such as voltage, current, frequency, power factor, and power, etc.

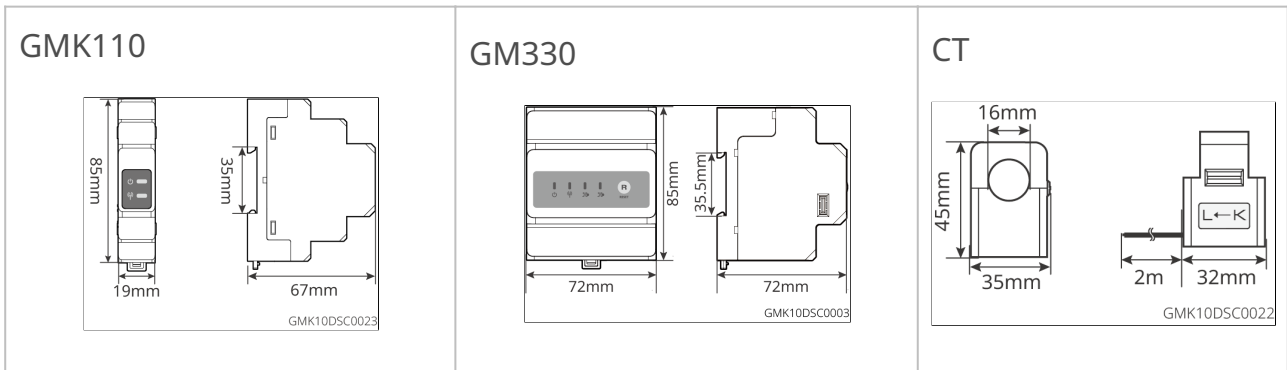

No.	Model	Applicable scenarios
1	GMK110	It is not supported to change the CT to other type, CT ratio: 120A: 40mA
2	GM330	<p>Supports purchasing from GOODWE or third-party, CT ratio requirement: nA: 5A</p> <ul style="list-style-type: none"> <li>nA: CT Primary side input current, the range of n is 200-5000</li> <li>5A: CT Secondary side output voltage.</li> </ul>

### 3.2.3 Smart Dongle

The smart dongle can transmit various power generation data to the remote monitoring platform, in real time, and can communicate with the SolarGo App to complete the near-end equipment commissioning.

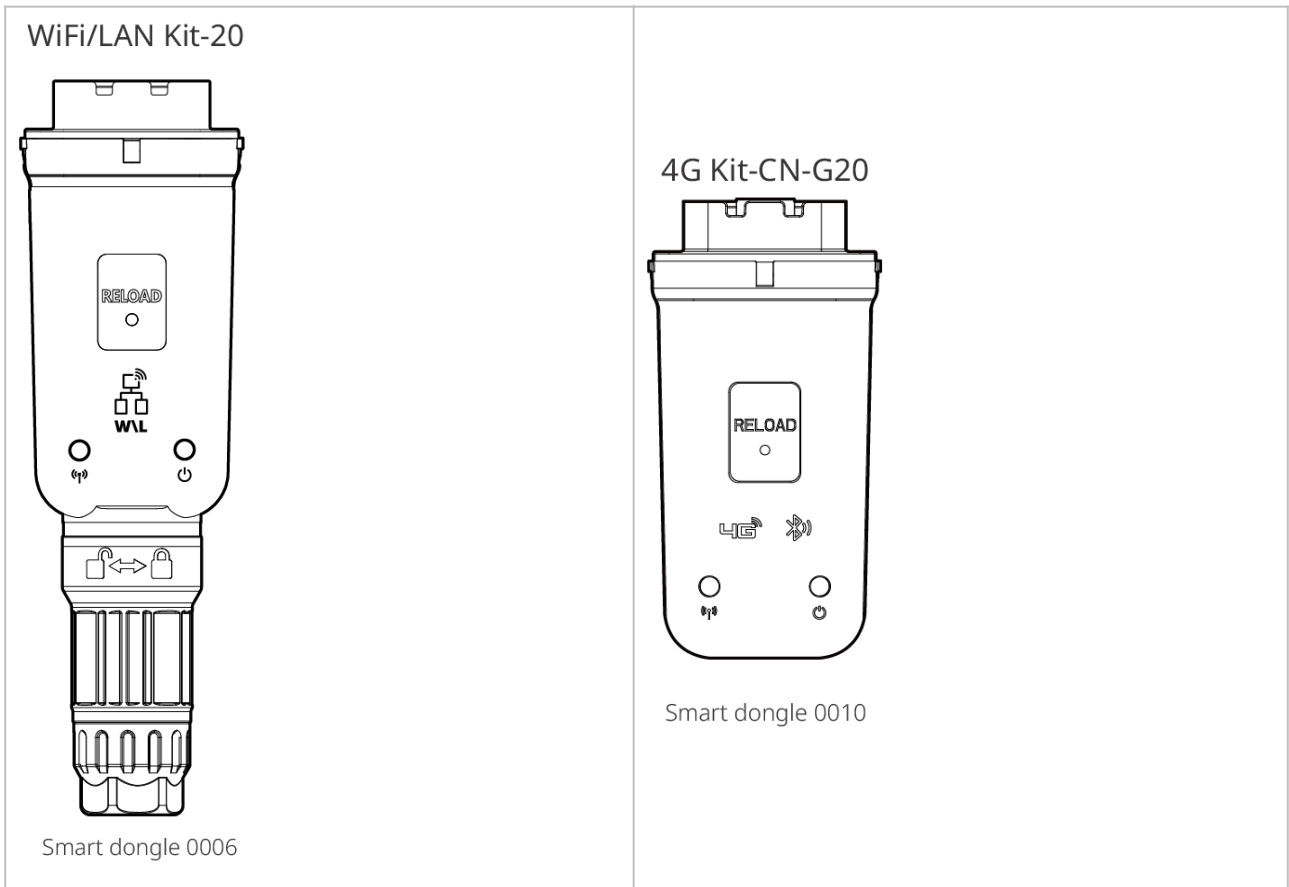

No.	Model	Signal	Applicable scenarios
1	WiFi/LAN Kit-20	WiFi, LAN, Bluetooth	Single inverter scenario, multi inverter scenario
2	4G Kit- CN-G20 (Only for China)	4G、 Bluetooth	Single inverter scenario

### 3.3 Supported Grid Types

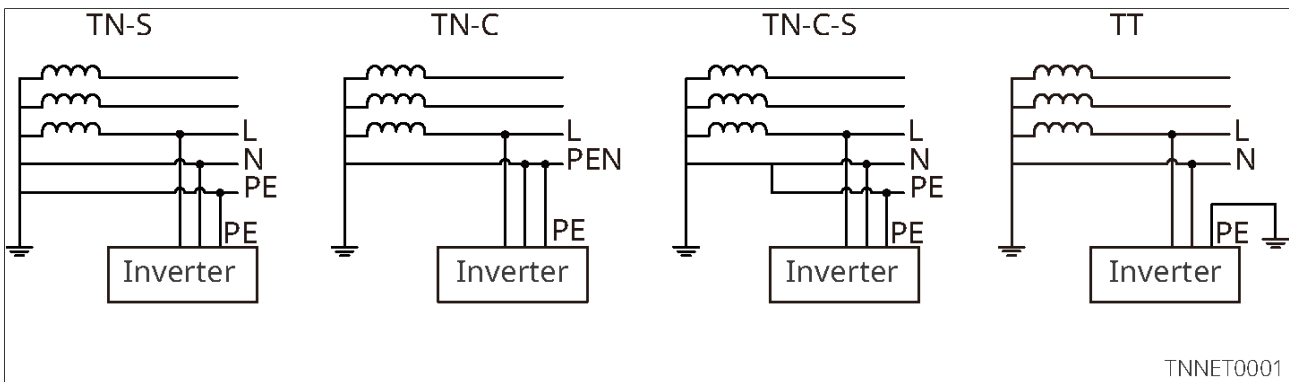

TNNET0001

## 3.4 System Working Mode

### Self-use Mode

- Self-use mode is the basic working mode of the system.
- The power generated by the PV system supply the loads in priority; the excess power will charge the batteries, and then the remaining power will be sold to the utility grid. When the power generated in the PV system is insufficient, the battery will supply the loads in priority. If the battery power is insufficient, the load will be powered by the utility grid.

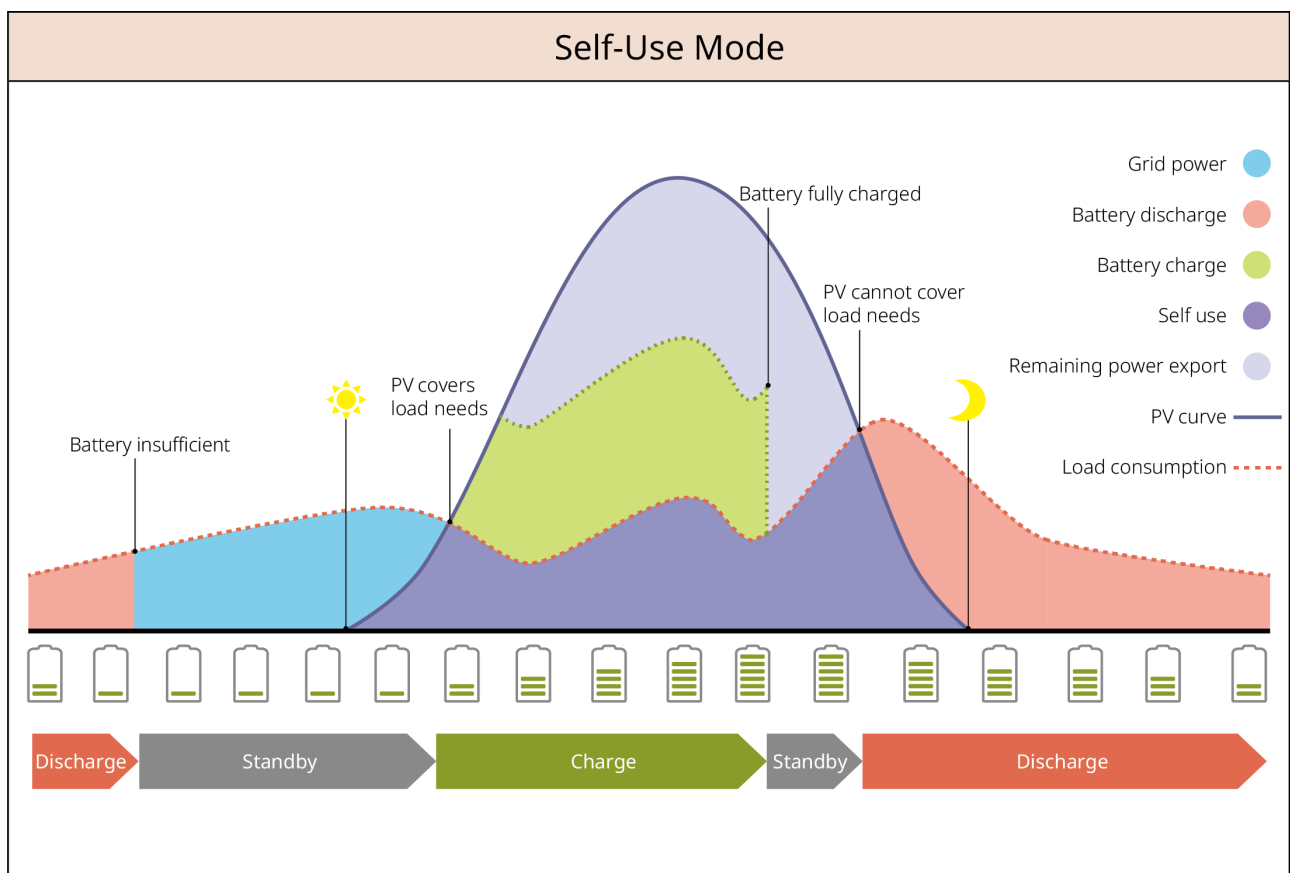

SLG00NET0009

### BACK-UP Mode

- The BACK-UP mode is mainly applied to the scenario where the grid is unstable.
- When the grid is disconnected, the inverter turns to off-grid mode and the battery will supply power to the BACK-UP loads; when the grid is restored, the inverter switches to on-grid mode.
- To ensure that the battery SOC is sufficient to maintain normal operation of the

system when it is off grid, the battery will be charged to the backup power SOC using PV or grid power during on-grid operation. If you need to purchase electricity from the power grid to charge the battery, please confirm compliance with local power grid laws and regulations.

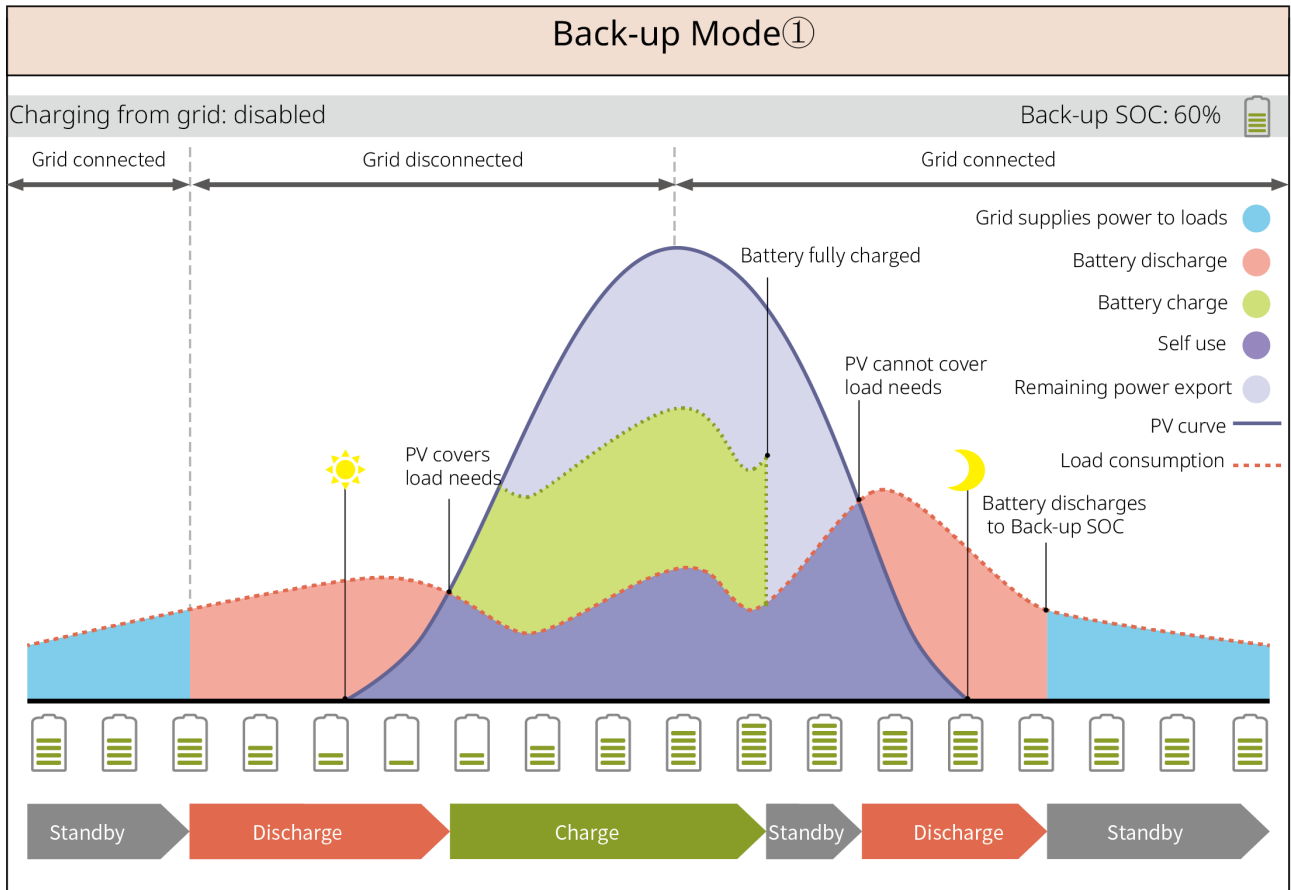

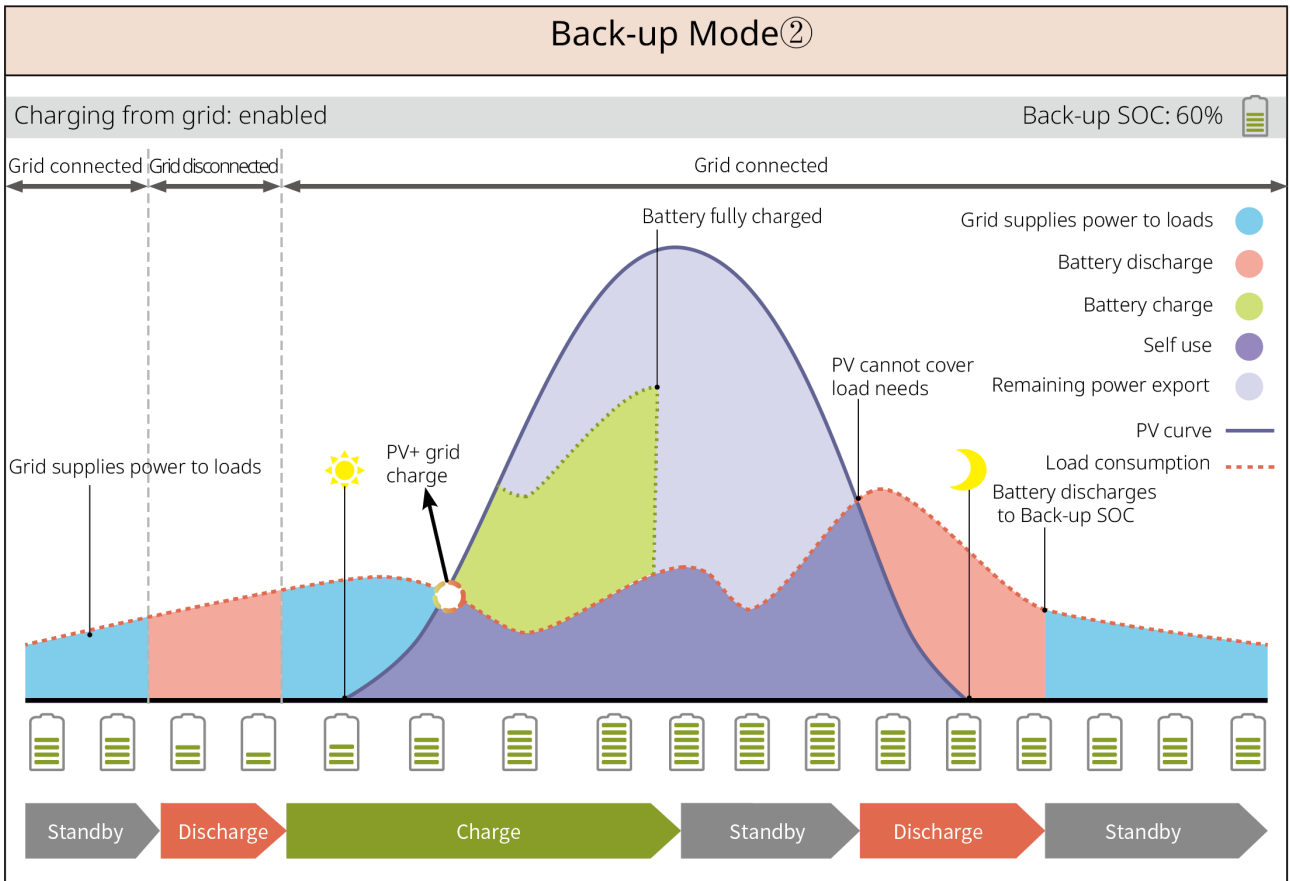

SLG00NET0003

## TOU Mode

It is recommended to use TOU mode in scenarios when the peak-valley electricity price varies a lot. Select TOU mode only when it meets the local laws and regulations. For example, set the battery to charge mode during Valley period to charge battery with grid power. And set the battery to discharge mode during Peak period to power the load with the battery.

# TOU Mode①

PV: Charge battery in priority

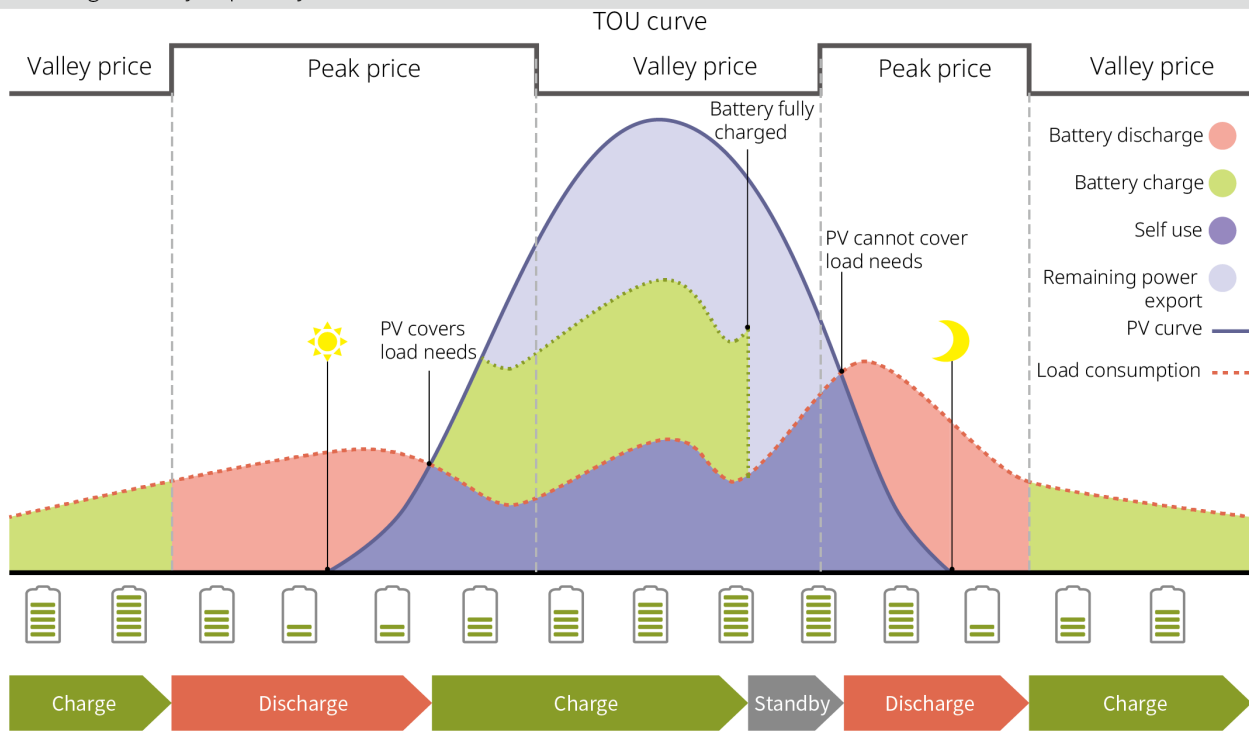

SLG00NET0004

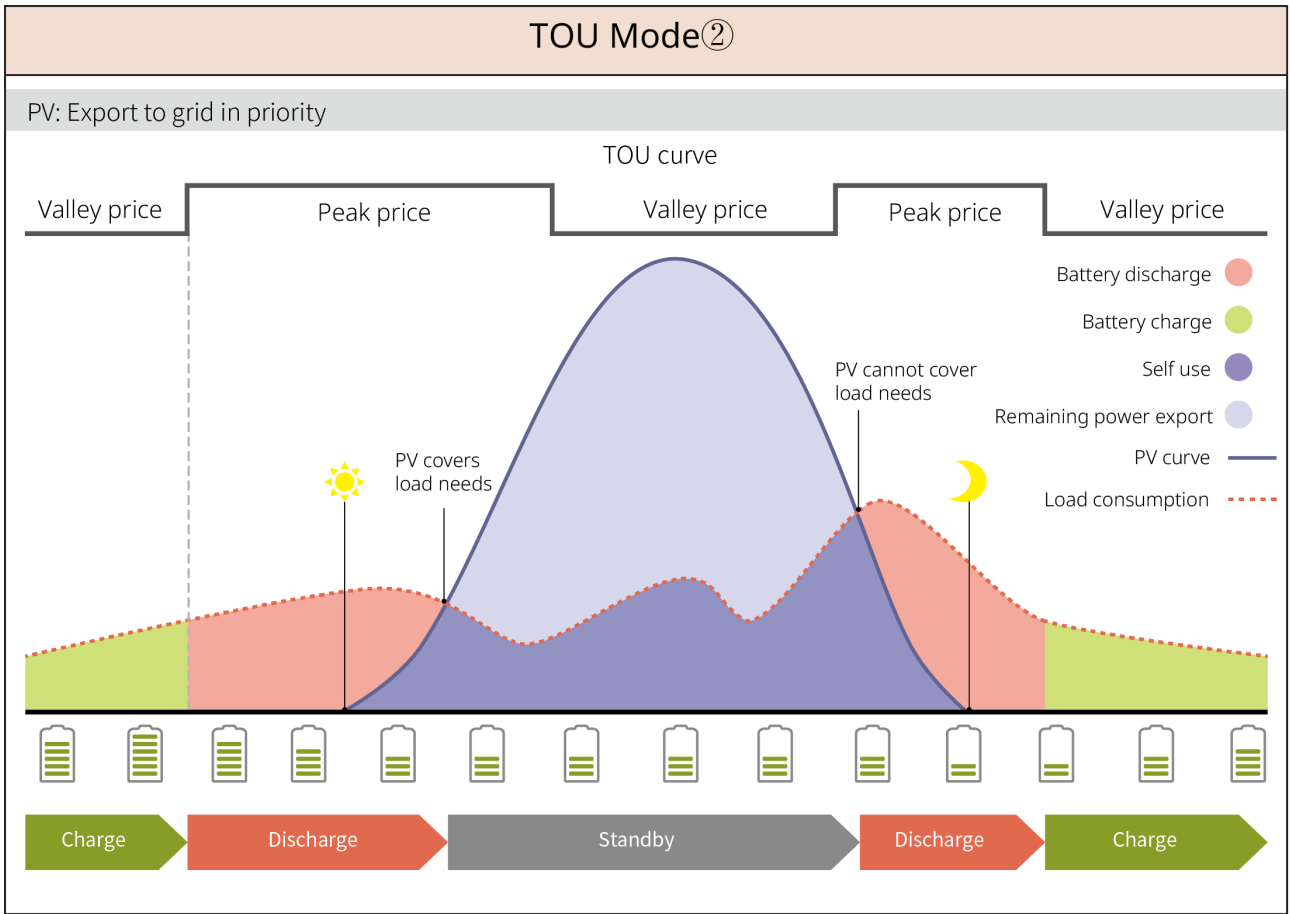

SLG00NET0005

### Delayed Charging Mode

- Suitable for areas with on-grid power output restrictions.
- Setting a peak power limit allows the PV power that exceeds the on-grid limit to be used to charge the battery; or setting a PV charging time period, during which the PV power is utilized to charge the battery.

# Smart Charging ①

PV > Peak Limit

Switch to Charge: enabled/disabled

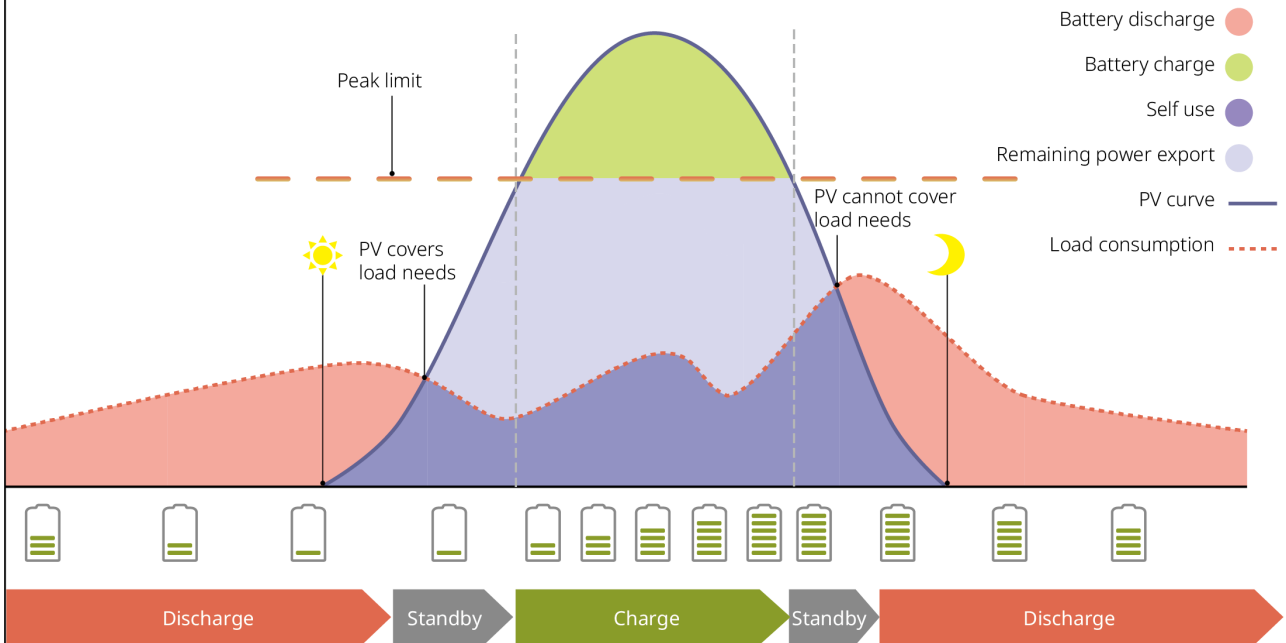

SLG00NET0006

## Smart Charging ②

PV < Peak Limit

Switch to Charge: enabled

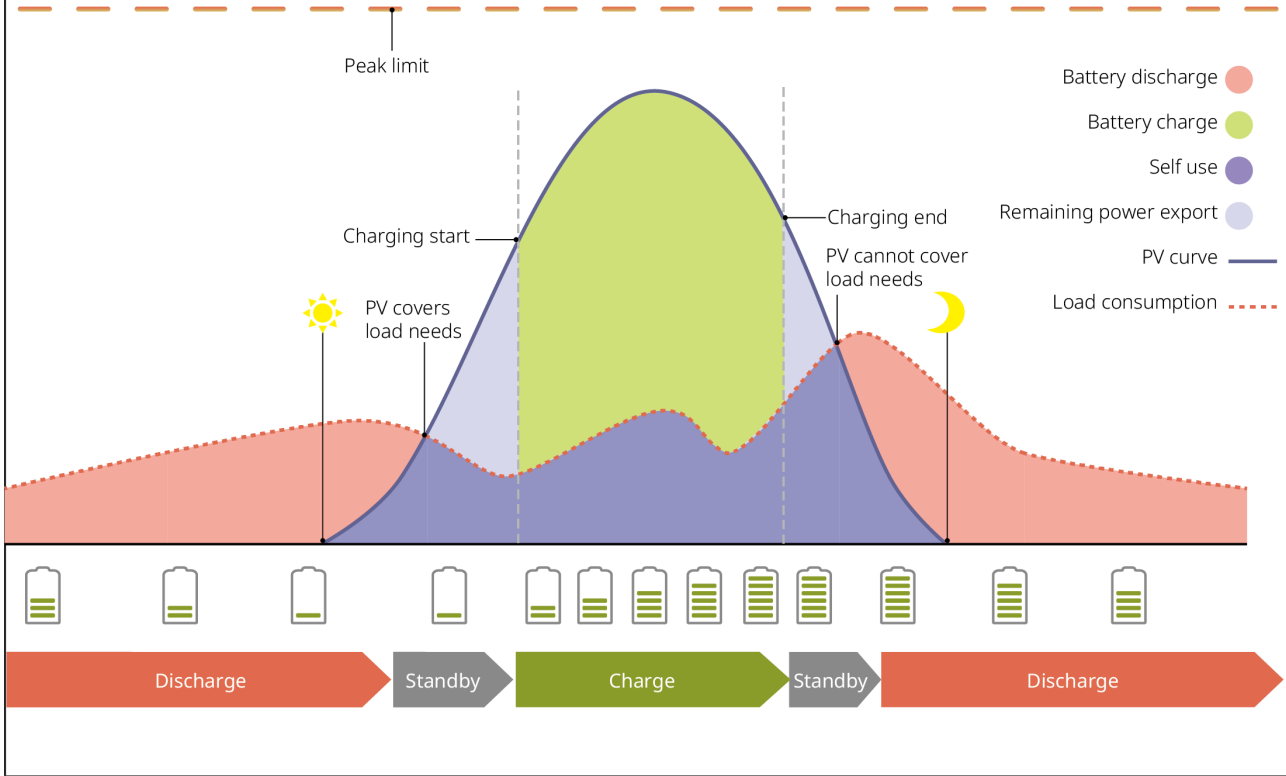

SLG00NET0007

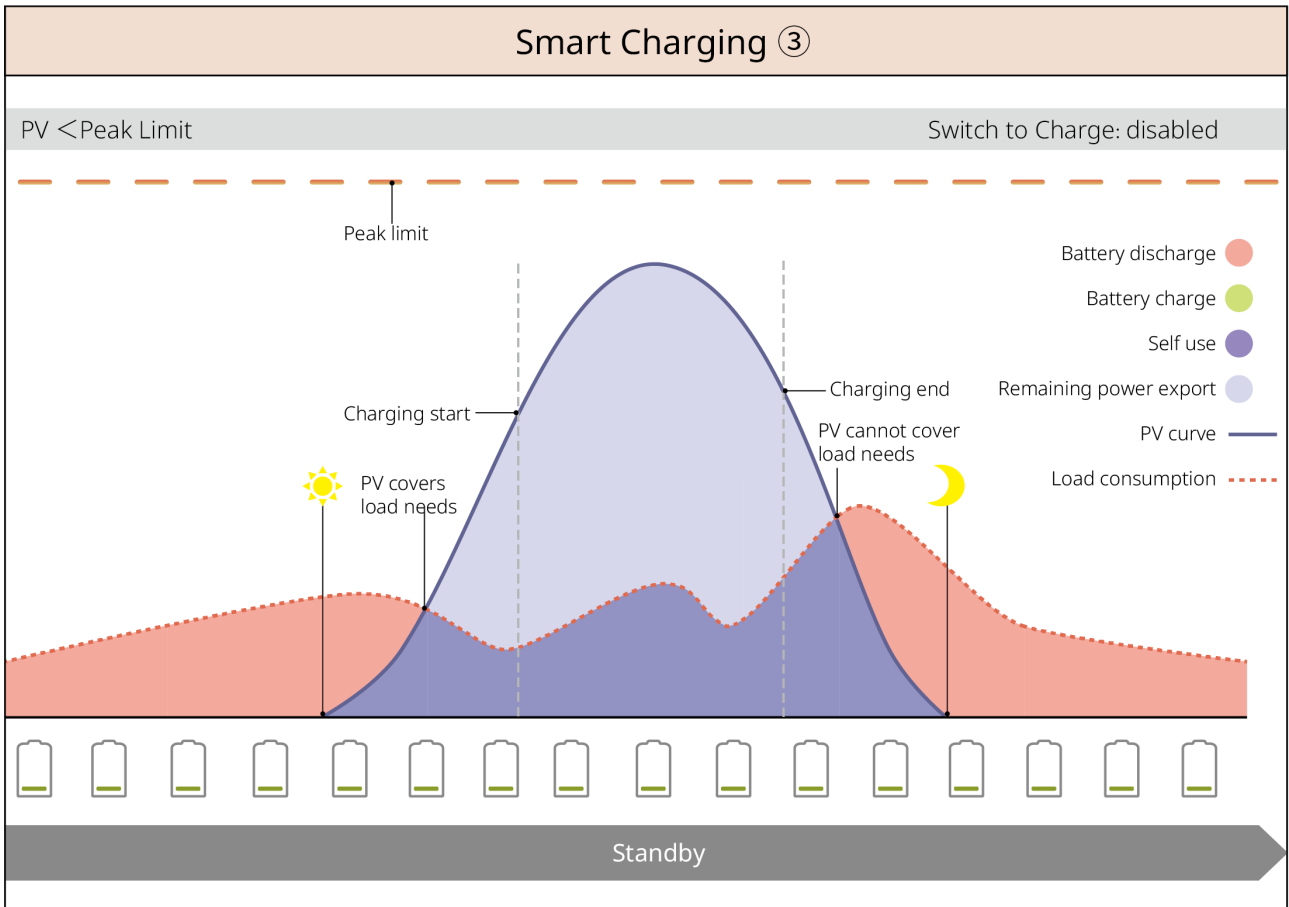

SLG00NET0008

### Demand Management Model

- It is mainly applicable to industrial and commercial scenarios.
- When the total power consumption of the load exceeds the power quota within a short period of time, battery discharge can be used to reduce the amount of power consumption exceeding the quota.
- When the battery SOC is below the reserved SOC for demand management, the system buys power from the grid based on the time period, load power usage, and the peak power buy limit.

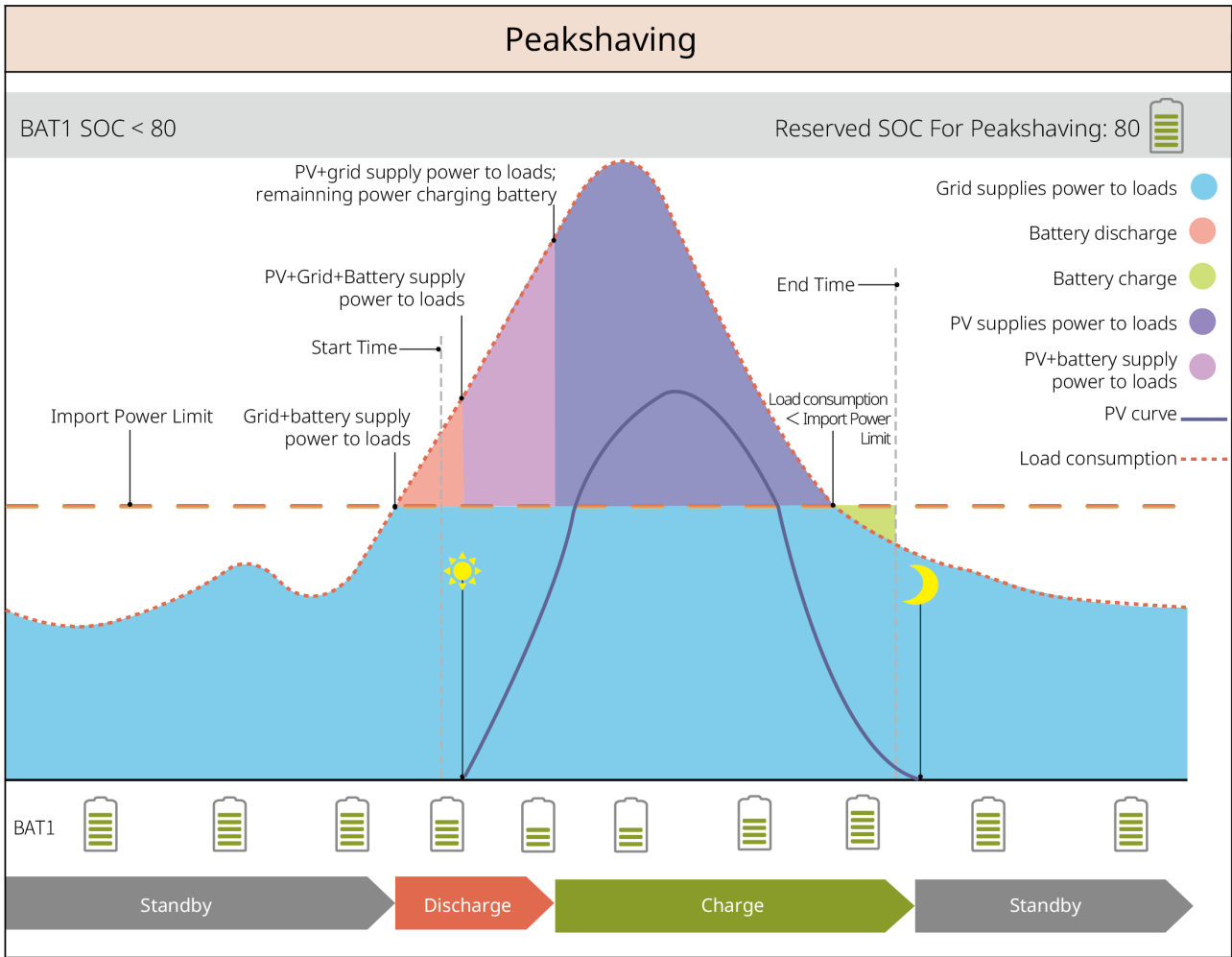

SLG00NET0001

## Off-grid Mode

### NOTICE

Please do not operate the energy storage system in pure off-grid mode for long periods of time, otherwise there is a risk of over-discharge when the battery cannot be charged in low temperature or low light conditions.  
 Do not operate in pure off-grid mode when the inverter is not connected to the battery system.

When the power grid fails, the inverter switches to off-grid mode.

- During the day, PV power generation is prioritized for supplying power to loads, and excess power is used to charge batteries.
- Nighttime battery discharge powers the load to ensure uninterrupted power supply to the backup load.

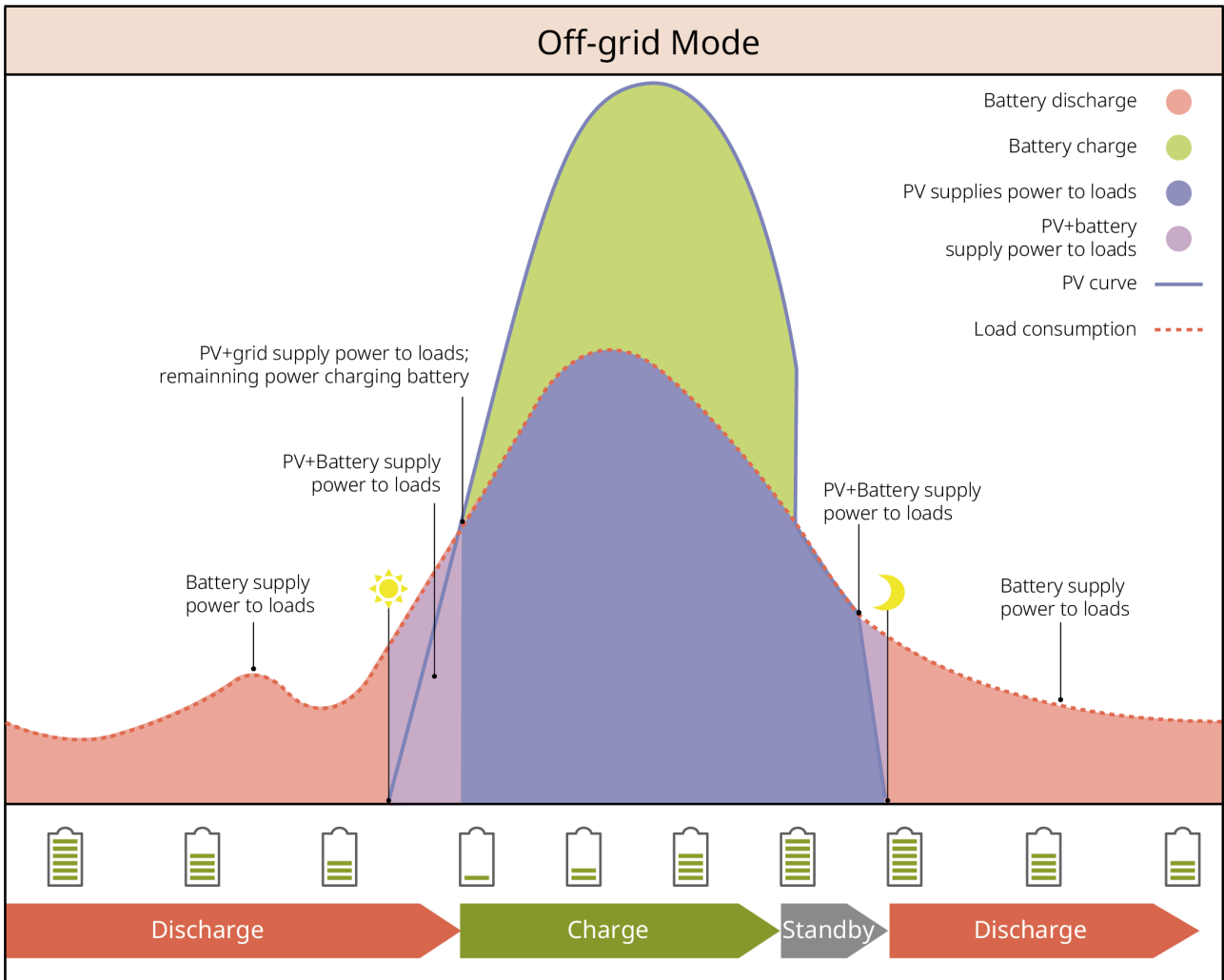

SLG00NET0012

### 3.5 Features

#### Notice

Please refer to the actual product configuration for specific functional features.

#### AFCI

The inverter is integrated with an AFCI (Arc-Fault Circuit Interrupter) protection device used to detect arc faults and rapidly disconnect the circuit to avoid electrical fires.

Reason to occur electric arcs:

- Damaged connectors in PV or battery system.
- Wrong connected or broken cables.

- Aging of connectors and cables.

Troubleshooting:

1. When the inverter detects an arc, the type of fault can be viewed through the display screen of the inverter or App.
2. The alarm can be cleared automatically in 5 minutes if the inverter triggers a fault for less than 5 times within 24 hours. The inverter will shutdown for protection after the 5th electric arc fault. The inverter can operate normally after the fault is solved. For more details, refer to the SolarGo APP User Manual.

Model	Label	Description
GW3K-EHA-G20 GW3.6K-EHA-G20 GW5K-EHA-G20 GW6K-EHA-G20	AFCI: F-I-AFPE-1-2-1	F: Full coverage I: Integrated AFPE: Detection and interruption capability provided 1: 1 monitored string per input port 2: 2 input ports per channel 1: 1 monitored channel
GW8K-EHA-G20 GW9.999K-EHA-G20 GW10K-EHA-G20	AFCI: F-I-AFPE-1-2/2-2	F: Full coverage I: Integrated AFPE: Detection and interruption capability provided 1: 1 monitored string per input port 2/2: 2/2 input ports per channel(AFD1: 2: AFD2: 1) 2: 2 monitored channels

Load Control

The inverter has a dry contact controlling port, which supports connecting additional contactors to enable/disable the load. It supports domestic loads, heat pumps, etc.

Load control methods are as follows:

- Time control: Set the time to turn the load on or off, and the load will automatically turn on or off within the set time period.

- Switch control: When the control mode is set to ON, the load turns on; when set to OFF, the load turns off.
- BACK-UP load control: The inverter is equipped with a built-in relay dry contact control port, which enables load on/off control via the relay. In off-grid mode, if the BACK-UP terminal is detected to be overloaded and the battery SOC is lower than the set value for battery off-grid protection, the load connected to the relay port can be turned off.

### Rapid Shutdown (RSD)

In the rapid shutdown system, the receiver and transmitter work together to shutdown the PV system rapidly. The receiver maintains the modules working by continuously receiving a heartbeat signal from a transmitter. The transmitter can be external or integrated into the inverter. In case of an emergency, you can enable the external initiator to shut down the transmitter, by which the RSD will stop working and the modules be shut down.

- External Transmitter
  - Transmitter Model: GTP-F2L-20, GTP-F2M-20  
[https://admin.goodwe.com/Ftp/EN/Downloads/User%20Manual/GW\\_RSD-20-Transmitter\\_User-Manual-EN.pdf](https://admin.goodwe.com/Ftp/EN/Downloads/User%20Manual/GW_RSD-20-Transmitter_User-Manual-EN.pdf)
  - Receiver Model: GR-B1F-20, GR-B2F-20  
[https://en.goodwe.com/Ftp/EN/Downloads/User%20Manual/GW\\_RSD-20\\_Quick-Installation-Guide-POLY.pdf](https://en.goodwe.com/Ftp/EN/Downloads/User%20Manual/GW_RSD-20_Quick-Installation-Guide-POLY.pdf)
- Integrated Transmitter
  - External initiator: external Switch
  - Receiver Model: GR-B1F-20, GR-B2F-20  
[https://en.goodwe.com/Ftp/EN/Downloads/User%20Manual/GW\\_RSD-20\\_Quick-Installation-Guide-POLY.pdf](https://en.goodwe.com/Ftp/EN/Downloads/User%20Manual/GW_RSD-20_Quick-Installation-Guide-POLY.pdf)

## 4 Check and Storage

### 4.1 Check Before Receiving

Check the following items before accept.





1. Check the outer packing box for damage, such as holes, cracks, deformation, and other signs of equipment damage. Do not unpack the package and contact the supplier as soon as possible if any damage is found.
2. Check the product model. If the product model is not what you requested, do not unpack the product and contact the supplier.



### 4.2 Deliverables

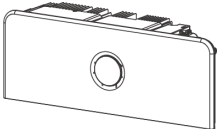

**⚠ WARNING**

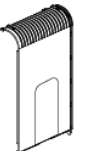
Check the deliverables for correct model, complete contents, and intact appearance. Contact the supplier as soon as possible if any damage is found.

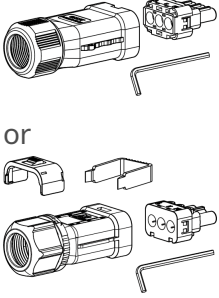
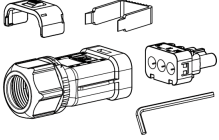
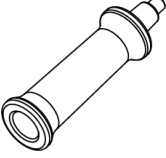
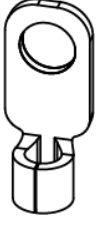
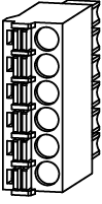
#### 4.2.1 Inverter Deliverables

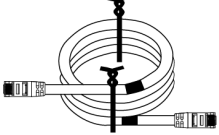
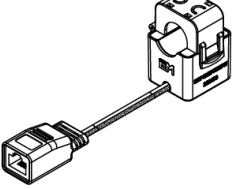
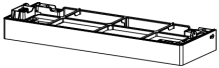
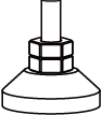
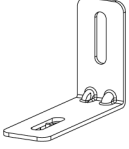
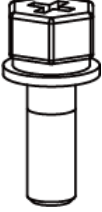
Component	Description	Component	Description
	Inverter x 1		Decorative cover x 1
	Left decorative cover x 1	<div style="display: flex; justify-content: space-around;"> <div style="border: 1px dashed black; padding: 2px;">  </div> <div style="border: 1px dashed black; padding: 2px;">  </div> </div>	Right decorative cover x 1

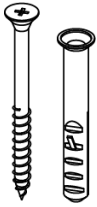
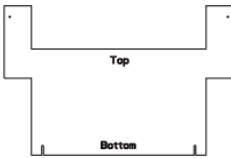
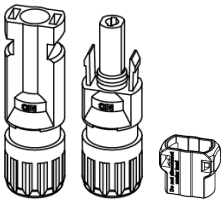
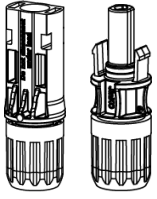
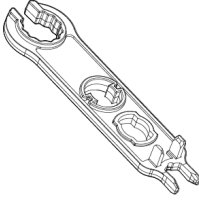
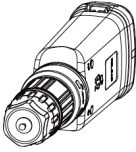
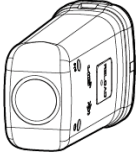
Component	Description	Component	Description
 <p>or</p> 	AC terminal x 2		Handle x 2
	OT grounding terminal x 1		6PIN Communication terminal x 2
	2PIN Communication terminal x 2		PIN terminal x 16
	CT connection cable x 1		CT x 1
	Battery Base x 1		Adjustable feet x 4
	Anti-tip bracket x 4		M5*16 bolt x 9

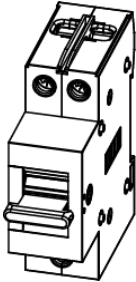

Component	Description	Component	Description
	M5*60 Expansion bolt x 4		Punch-marked paper x 2
 or 	PV terminal and PV terminal tamper-proof cover x N GW3K-EHA-G20, GW3.6K-EHA-G20, GW5K-EHA-G20, GW6K-EHA-G20 : 4 GW8K-EHA-G20, GW9.999K-EHA-G20, GW10K-EHA-G20 : 8 Note: There is no PV terminal tamper-proof cover in the China region.	   or 	PV terminal unlocking tool x 1 N: China Region x 0; Other Regions x 1  Smart dongle x 1
	Documents x 1		Manual switch (only for Australia) x 1 Note: Only for single inverter scenario.

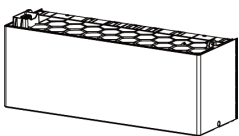
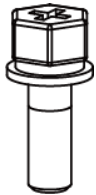
#### 4.2.2 Batteries Deliverables

Component	Description	Component	Description
	Battery x1		M5*16 bolts x 2

Component	Description	Component	Description
	Silicone cap x 2	-	-

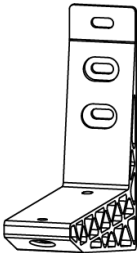
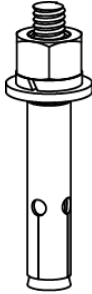



#### Hangar installation (optional)

Component	Description	Component	Description
	Bracket x 2		M10 Expansion bolts x 6
	M10 bolts x 4	-	-

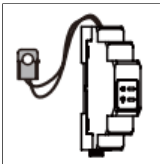
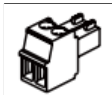



### 4.2.3 Smart Meter Deliverables

#### 4.2.3.1 GMK110

Component	Description	Component	Description
	Smart Meter and CT x 1		RS485 communication terminals x 1

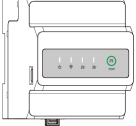
Component	Description	Component	Description
	Voltage input side terminal x 1		PIN terminal x 4
	Screw driver x 1		Documents x 1

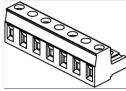
#### 4.2.3.2 GM330

Component	Description	Component	Description
	Smart Meter x1		2 PIN terminal x1
	PIN terminal x 6		7 PIN terminal x1
	Screw driver x 1		Documents x 1

### 4.3 Storage

- If the inverter has been stored for more than two years or has not been in operation for more than six months after installation, it is recommended to be inspected and tested by professionals before being put into use.
- To ensure good electrical performance of the internal electronic components of the inverter, it is recommended to power it on every 6 months during storage. If it has not been powered on for more than 6 months, it is recommended to be inspected and tested by professionals before being put into use.
- In order to protect the performance and service life of the battery, it is recommended to avoid unused storage for a long period of time. Prolonged storage may cause deep discharging of the battery, resulting in irreversible

chemical loss, leading to capacity degradation or even complete failure, timely use is recommended. If the battery needs to be stored for a long period of time, please maintain it according to the following requirements:

### Notice

[1] The storage time starts from the SN date on the outer packaging of the battery and requires charging and discharging maintenance after the storage cycle is exceeded. (Battery maintenance time = SN date + charging/discharging maintenance cycle). For SN date, refer to [14.4.Battery SN Code Meaning\(Page 376\)](#)

[2] After passing the charging/discharging maintenance, if there is a Maintaining Label attached to the outer box, then please update the maintenance information on the Maintaining Label. if there is no Maintaining Label, please record the maintenance time and SOC of the batteries and keep the data to facilitate the keeping of maintenance records.

Battery type	Initial SOC Range for Battery Storage	Storage Temperature (°C)	Charge and Discharge Maintaining Period <sup>[1]</sup>	Battery Maintenance Method <sup>[2]</sup>
GW5.1-BAT-D-G20	35~45%	0~35°C	-20~35°C, 12months 35~45°C, 6 months	Contact the dealer or the after-sales service for maintenance method.
GW8.3-BAT-D-G20				
GW5.1-BAT-D-G21				
GW8.3-BAT-D-G21				

Packing requirements:

Do not unpack the outer package or throw the desiccant away.

Environment Requirements:

1. Place the equipment in a cool place where away from direct sunlight.
2. Store the equipment in a clean place. Make sure the temperature and humidity are appropriate and no condensation. Do not install the equipment if the ports or terminals are condensed. Battery storage temperature range:

3. Keep the equipment away from flammable, explosive, and corrosive matters.

Stacking requirements:

1. The height and direction of the stacking inverter should follow the instructions on the packing box.
2. The inverter must be stacked with caution to prevent them from falling.

## 5 Installation



Install and connect the equipment with the deliverables included in the package. Otherwise, the manufacturer shall not be liable for the damage.

### 5.1 Installation Requirements

#### 5.1.1 Installation Environment Requirements

1. Do not install the equipment in a place near flammable, explosive, or corrosive materials.
2. The temperature and humidity at the installation site should be kept within the appropriate range.
3. Keep away from children.
4. High temperatures may exist on the surface of the equipment during operation to prevent burns.
5. Install the equipment in a sheltered place to avoid direct sunlight, rain, and snow. Build a sunshade if it is needed.
6. The place to install the equipment shall be well-ventilated for heat radiation and large enough for operations.
7. Check the protection rating of the equipment and ensure that the installation environment meets the requirements. The inverter, battery system, and smart dongle can be installed both indoors and outdoors, but the smart meter can only be installed indoors.
8. Install the equipment at a height that is convenient for operation and maintenance, electrical connections, and checking indicators and labels.
9. The altitude to install the inverter shall be lower than the maximum working altitude of the system.
10. Consult the manufacturer before installing the equipment outdoors in salt affected areas. A salt-affected area refers to the region within 500 meters offshore, and will be related to the sea wind, precipitation and topography.
11. This inverter has not been tested and verified in accordance with the AS/NZS 4777.2:2020 standard for combinations of multiple inverters and/or multi-phase inverter combinations. Therefore, such combination schemes should not be used.
12. Install the equipment away from electromagnetic interference. If there is any radio or wireless communication equipment below 30MHz near the equipment, you have

to:

- Inverter: add a multi-turn winding ferrite core at the AC output cable of the inverter, or add a low-pass EMI filter. Or the distance between the inverter and the wireless EMI equipment should be more than 30m.
- Other equipment: the distance between the equipment and the wireless EMI equipment should be more than 30m.

## NOTICE

- Inverter Operating Temperature Range:  $-35^{\circ}\text{C}$ - $60^{\circ}\text{C}$ .
- GW5.1-BAT-D-G20, GW8.3-BAT-D-G20: Charging temperature range:  $-18^{\circ}\text{C}$ - $55^{\circ}\text{C}$ ; Discharging temperature range:  $-20^{\circ}\text{C}$ - $55^{\circ}\text{C}$ . If installed in an environment below  $-18^{\circ}\text{C}$ , the battery will not be able to continue charging to restore energy after being discharged, resulting in undervoltage protection.
- GW5.1-BAT-D-G21, GW8.3-BAT-D-G21: Charging temperature range:  $2^{\circ}\text{C}$ - $55^{\circ}\text{C}$ ; Discharging temperature range:  $-20^{\circ}\text{C}$ - $55^{\circ}\text{C}$ . If installed in an environment below  $2^{\circ}\text{C}$ , the battery will not be able to continue charging to restore energy after being discharged, resulting in undervoltage protection.

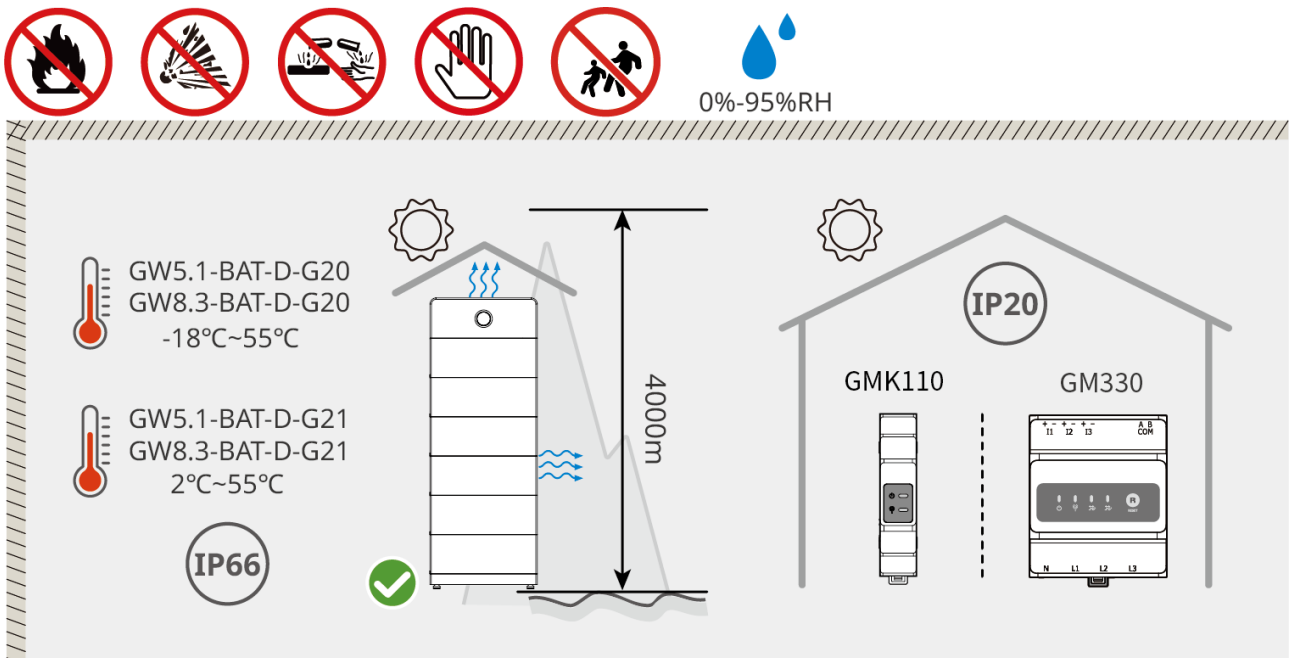

ESA20INT0007

## 5.1.2 Installation Space Requirements

Reserve enough space for operations and heat dissipation when installing the system.

- When using CAT 7E communication cables among inverters, the maximum distance can reach 10 meters, while using CAT 5E or CAT 6E communication cables, the maximum distance can reach 5 meters. The length of the communication cable should not exceed 10 meters; otherwise, it may cause communication abnormality.
- For the installation of the CT, a shielded network cable of CAT 5E or higher grade must be used, and the cable length should not exceed 30 meters.
- For the RS485 twisted-pair shielded cable used for communication between the inverter and the smart meter, the cable length should not exceed 100 meters.

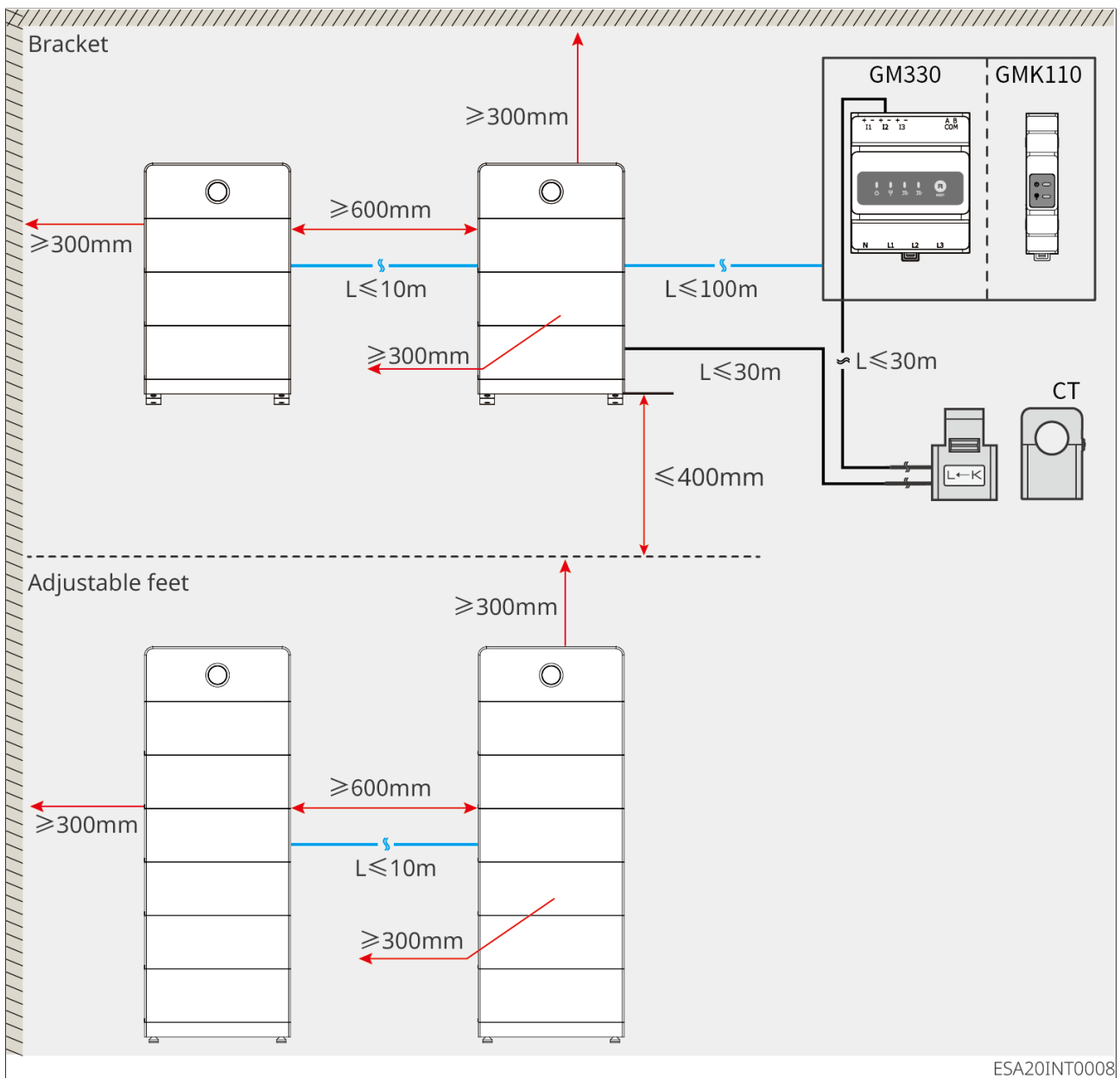









### 5.1.3 Tool Requirements

#### NOTICE

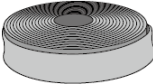

The following tools are recommended when installing the equipment. Use other auxiliary tools on site if necessary.

#### Installation Tools

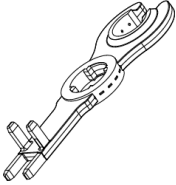
Tool Type	Description	Tool Type	Description
	Diagonal pliers		RJ45 crimping tool
	Wire stripper		Level ruler
	Adjustable wrench		PV connector tool PV-CZM-61100
	Impact drill (drill bits Φ12mm)		Torque wrench M4, M5, M6, M10
	Rubber hammer		Socket wrench set
	Marker		Multimeter Range≤600V
	Heat shrink tube		Heat gun

Tool Type	Description	Tool Type	Description
	Cable tie		Vacuum cleaner
	(Only for China) PV Unlocking tool x1	-	-

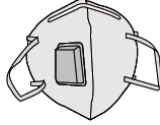
### Personal Protective Equipment

Tool Type	Description	Tool Type	Description
	Insulating gloves, protective gloves		Dust mask
	Goggles		Safety shoes

## 5.2 Equipment Handling

## ⚠ CAUTION

- Operations such as transportation, turnover, installation and so on must meet the requirements of the laws and regulations of the country or region where inverters are installed.
- Move the equipment to the site before installation. Follow the instructions below to avoid personal injury or equipment damage.
  1. Consider the weight of the equipment before moving it. Assign enough personnel to move the equipment to avoid personal injury.
  2. Wear safety gloves to avoid personal injury.
  3. Keep balance to avoid falling down when moving the equipment.
  4. The battery system can be transported to the installation site by crane.
  5. When moving equipment using a hoisting method, please use flexible slings or straps. The load-bearing capacity of a single strap must meet the following requirements:
    - GW5.1-BAT-D-G20, GW5.1-BAT-D-G21  $\geq 180\text{KG}$
    - GW8.3-BAT-D-G20, GW8.3-BAT-D-G21  $\geq 240\text{KG}$

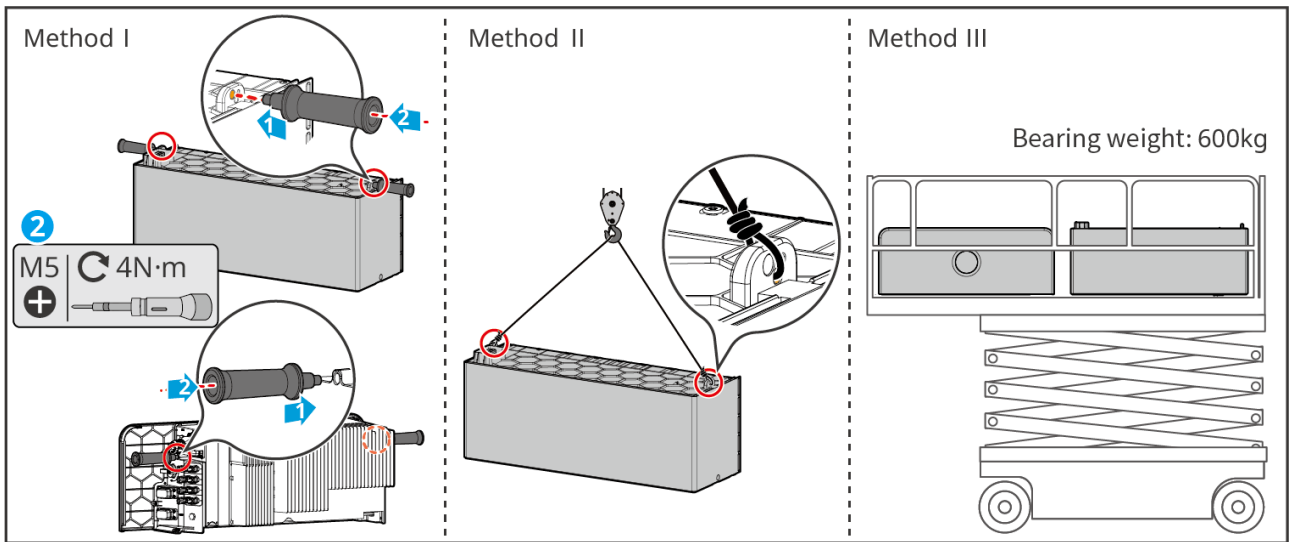

## 5.3 Equipment Installation

## CAUTION

- Avoid the water pipes and cables buried in the wall when drilling holes to avoid risks.
- Wear goggles and a dust mask to prevent the dust from being inhaled or contacting eyes when drilling holes.
- Install the inverter above the battery, do not install the battery above the inverter.
- Ensure that the battery system is installed vertically and securely. Ensure that the holes of the upper and lower layers are aligned when placing the battery base, battery, and inverter. The anti-tip bracket should be vertically attached to the ground, wall, or battery system surface.
- Cover the equipment with a cardboard to prevent foreign matters when drilling holes. Otherwise, the system may be damaged.

## Notice

- The battery must be installed on the base, which can be installed on the ground or on a hanging bracket.
- When using the base for installation, up to six batteries can be stacked.
- The maximum stacking quantity when using a mounting bracket is specified as follows:
  - Identical Energy Stack:
    - GW5.1-BAT-D-G20, GW5.1- BAT-D-G21: Maximum of 3 pieces.
    - GW8.3-BAT-D-G20, GW8.3- BAT-D-G21: Maximum of 2 pieces.
  - Energy Overlap:
    - When GW5.1-BAT-D-G20, GW5.1-BAT-D-G21 are stacked, GW8.3-BAT-D-G20, and GW8.3-BAT-D-G21, a maximum of two units can be stacked.
- The base, bracket, and top battery must be secured to the wall with anti-tip brackets.
- When marking the drilling positions for the hanger installation, one person should hold the base firmly, while the other uses a marker pen to mark the drilling positions.
- When installing the battery and inverter, remove the protective cover from the blind mating connector before stacking.

## Installing the brackets

**Step 1:** Install the base on the hanger.

**Step 2:** Hang the hanger close to the wall. Ensure that the hanger is securely in place and check the level bubble in the center of the base.

**Step 3:** After adjusting the position and level of the hanger, use a marker pen to mark the drilling positions. Once marking is done, remove the hanger. (A: PACK fixing holes; B: Bracket fixing holes.)

**Step 4:** Drill holes and install expansion screws.

Step 5 Secure the mounting plate using the expansion bolts.

1. Drill holes with the impact drill.
2. Clean the holes.
3. Use a rubber mallet to install the expansion screws into the holes.
4. Use an Allen wrench to tighten the nut clockwise to expand the screw.
5. Remove the nut by turning it counterclockwise.
6. Use a torque screwdriver to secure the anti-tip bracket to the wall.

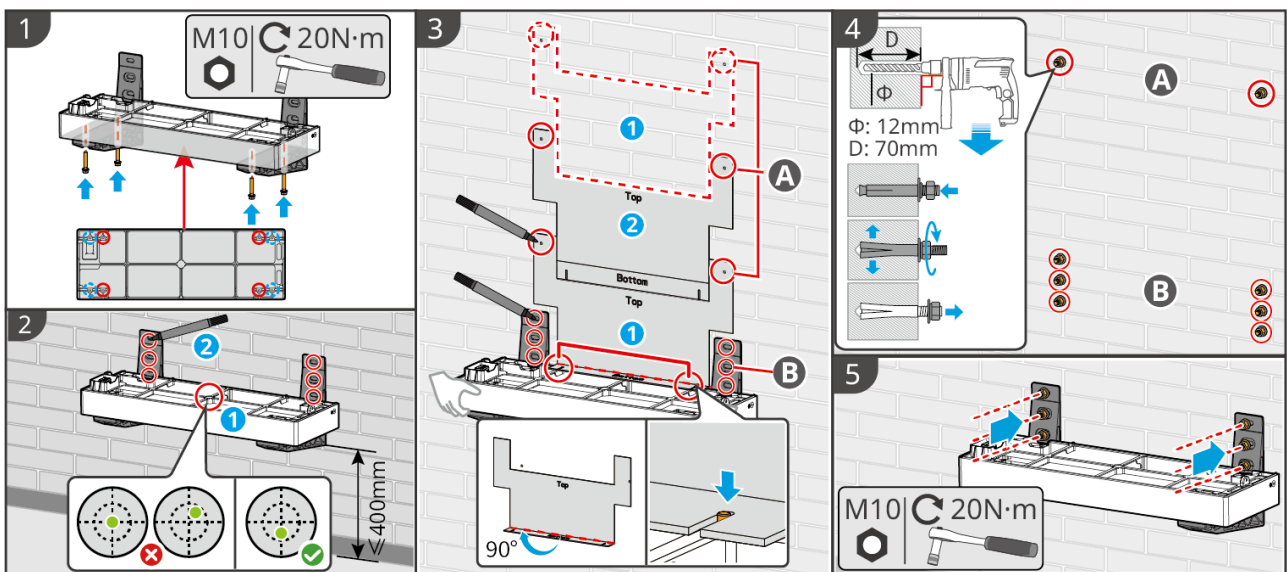

ESA20INT0003

## Installation base

**Step 1:** Install the adjustable feet on the bottom of the base and secure the anti-tip bracket to the base.

**Step 2:** Place the base 35-55mm away from the wall, keeping it parallel to the wall. Observe the level bubble in the center of the base. If the bubble is not centered, use the adjustable feet to level the base.

**Step 3:** After adjusting the position and level of the base, use the hole marking paper

to mark the hole positions. Once the marking is complete, remove the base. (A: PACK fixing holes; B: Bracket fixing holes.)

**Step 4:** Use an impact drill to drill holes and clean them.

**Step 5:** Use a Phillips screwdriver to secure the anti-tip bracket to the wall.

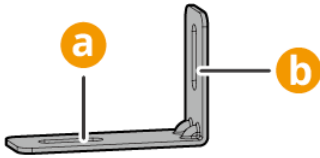

a: Fixed to the base; b: Fixed to the wall.

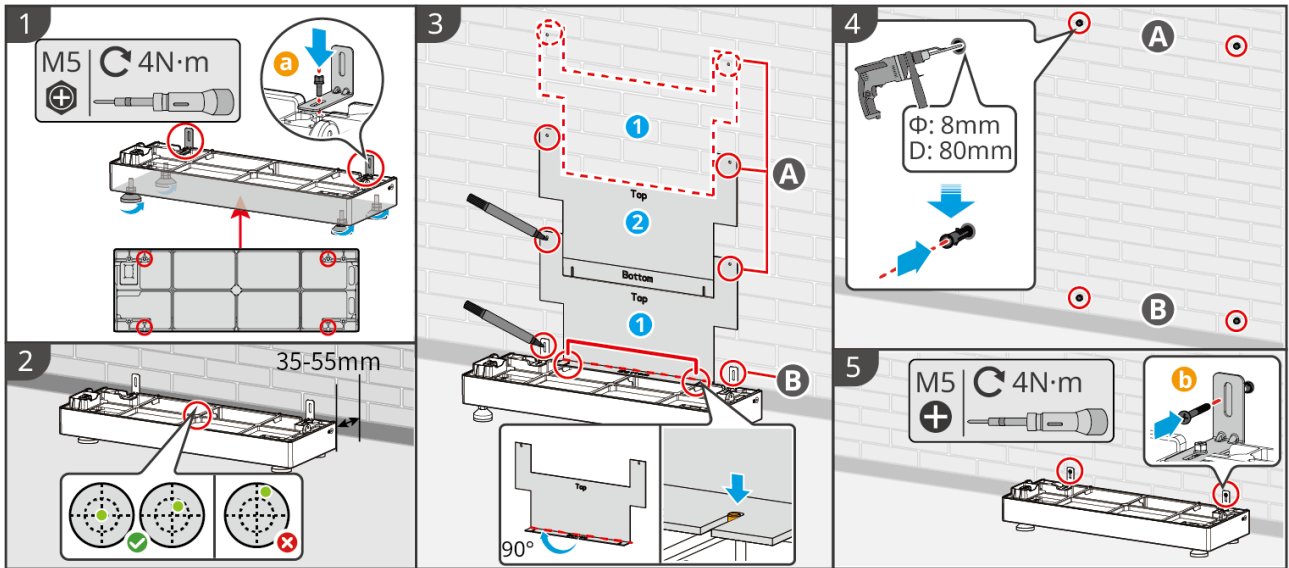

ESA20INT0004

### Installing the Battery and the Inverter

**Step 1:** Install the handle (optional), remove the protective cover from the battery blind mating connector, and stack the batteries on the base.

If installing more than three battery, please use lifting equipment.

**Step 2:** Tighten the screws securing the battery to the base or between batteries.

If you need to install multiple batteries, repeat **step 1 and step 2** to complete the installation of all batteries. Do not stack more than 6 batteries in a single group.

**Step 2:** The base, bracket, and top battery must be secured to the wall with anti-tip brackets.

**Step 4:** Remove the protective cover from the blind mating connector at the bottom of the inverter.

**Step 5:** Lift the inverter and stack it on top of the battery, then tighten the screws between the inverter and the battery.

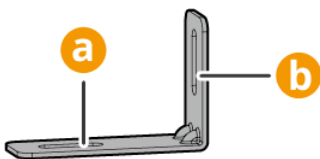

a: Fixed to PACK; b: Fixed to the wall.

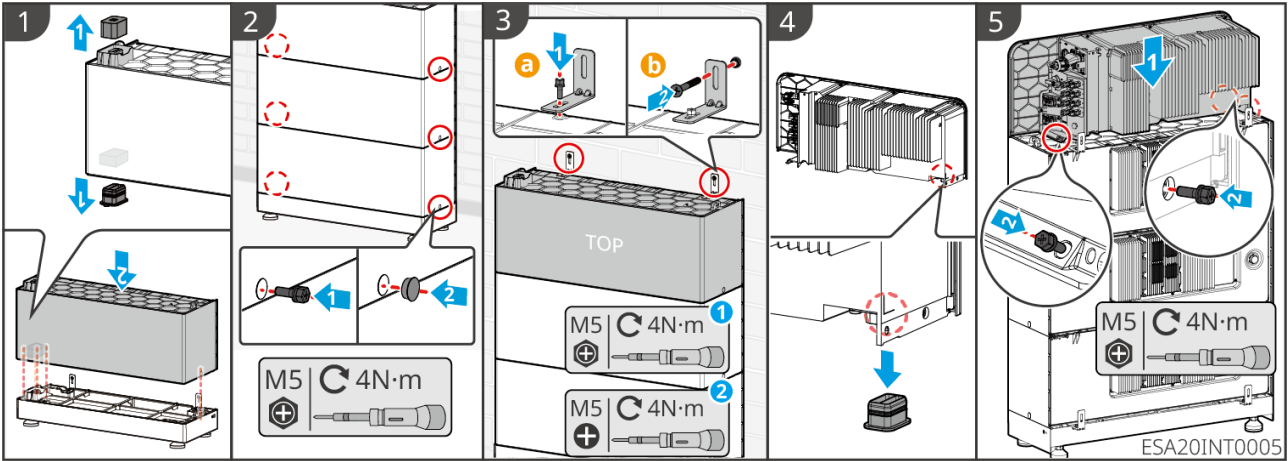

## 5.4 Installing the Smart Meter

### ⚠ WARNING

In areas at risk of lightning, if the meter cable exceeds 10m and the cables are not wired with grounded metal conduits, you are recommended to use an external lightning protection device.

GMK110

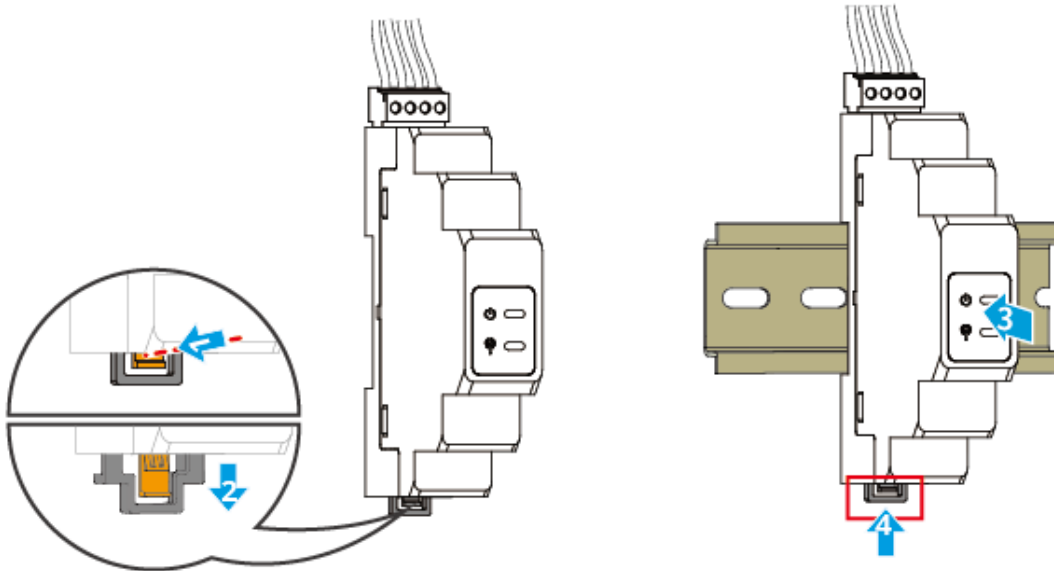

GM330

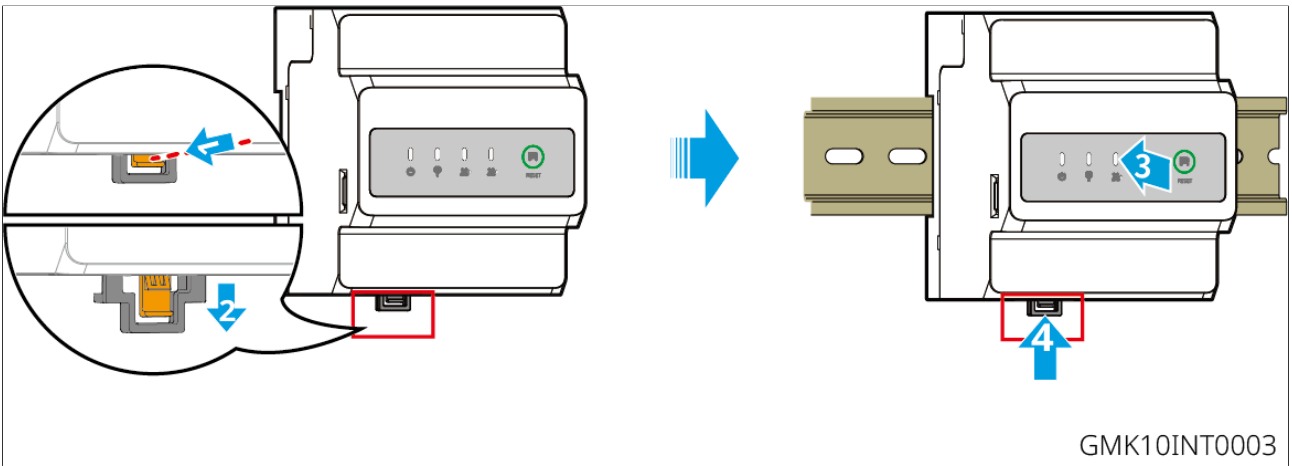

## 6 System Wirings

### DANGER

- The erection, routing, and connection of cables must be in compliance with local laws and regulations.
- Perform electrical connections in compliance with local laws and regulations, including operations, cables, and component specifications.
- Disconnect the DC switches and the AC output switches to power off the equipment before any electrical connections. Do not work with power on. Otherwise, an electric shock may occur.
- Tie the same type cables together, and place them separately from cables of different types. Do not place the cables entangled or crossed.
- If the cable bears too much tension, the connection may be poor. Reserve a certain length of the cable before connecting it to the inverter cable port.
- Make sure that the cable conductor is in full contact with the terminal and the cable insulation part is not crimped with the terminal when crimping the terminal. Otherwise, the device may not be able to work properly, or the connection may be unreliable during working, which may cause terminal block damage, etc..

### NOTICE

- Wear personal protective equipment like safety shoes, safety gloves, and insulating gloves during electrical connections.
- All electrical connections should be performed by qualified professionals.
- Cable colors in this document are for reference only. The cable specifications shall meet local laws and regulations.

### 6.1 System Wiring Electrical Block Diagram

## NOTICE

- N and PE wiring of ON-GRID and BACK-UP ports of the inverter are different according to the regulation requirements of different regions. Refer to the specific requirements of local regulations.
- The inverter has a built-in electric meter that can be directly connected to a CT for use. The CT network cable included in the box is 10 meters long. If you need a longer cable, you can use a CAT5E or higher shielded network cable to extend it to 30 meters.
- When the length of the connection between the CT and the inverter exceeds 30 m, accuracy will decrease. If high accuracy is required, an external smart meter can be connected.
- The inverter features built-in relays for the ON\_GRID and BACK\_UP AC ports. When the inverter is in off-grid mode, the built-in ON\_GRID state relay is disconnected; when the inverter is in on-grid operation mode, the built-in ON-GRID relay is connected.
- When the inverter is powered on, the BACK-UP AC port is energized. Power off the inverter first if maintenance is required on the BACK-UP loads. Otherwise, it may cause electric shock.

### **N and PE cables are connected together in the Main Panel.**

## NOTICE

- To maintain neutral integrity, the neutral lines on the grid-connected side and the off-grid side must be connected together, otherwise the off-grid function will not work properly.
- The figure below shows a schematic diagram of the power grid systems in Australia, New Zealand, and other regions:

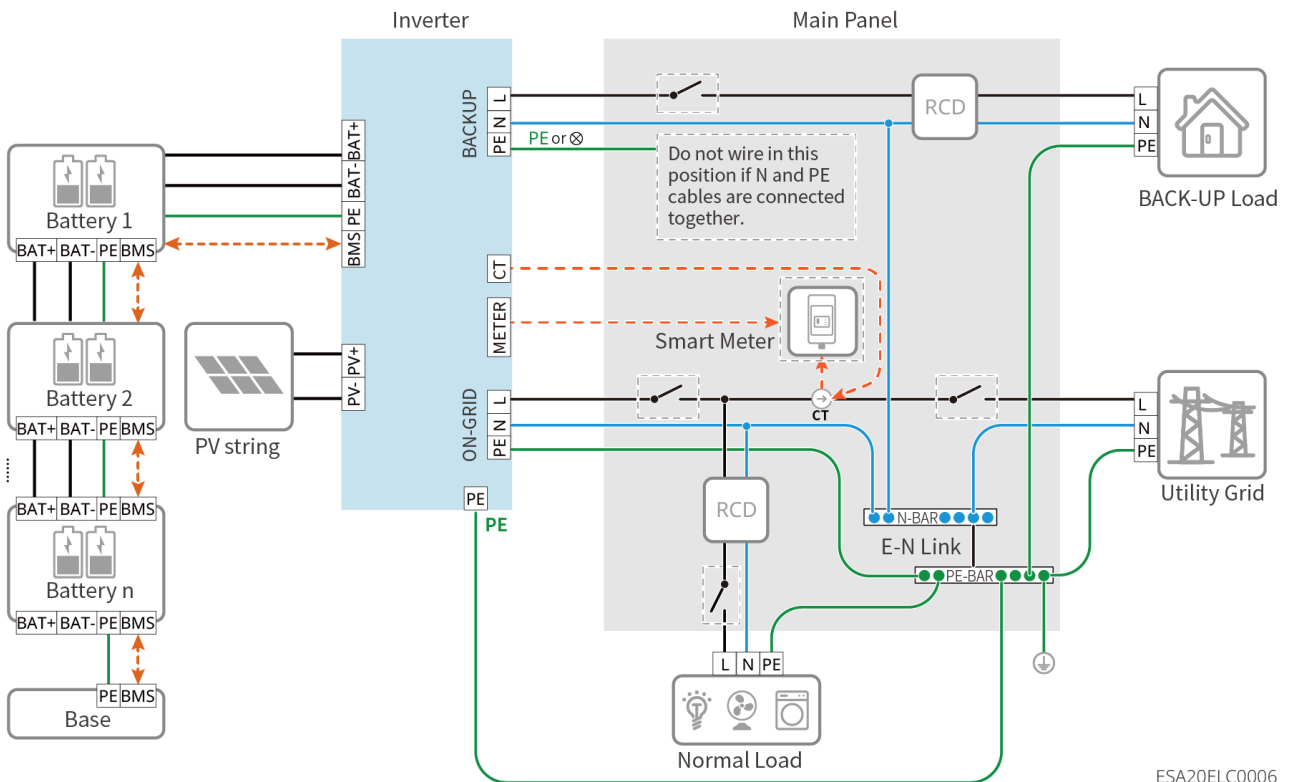

ESA20ELC0006

**N and PE cables are separately wired in the Main Panel.**

### NOTICE

- Ensure that the grounding of BACK-UP is correctly tightened. Otherwise, the BACK-UP function may be abnormal in case of grid failure.
- The following diagram is applicable to areas except Australia or New Zealand.

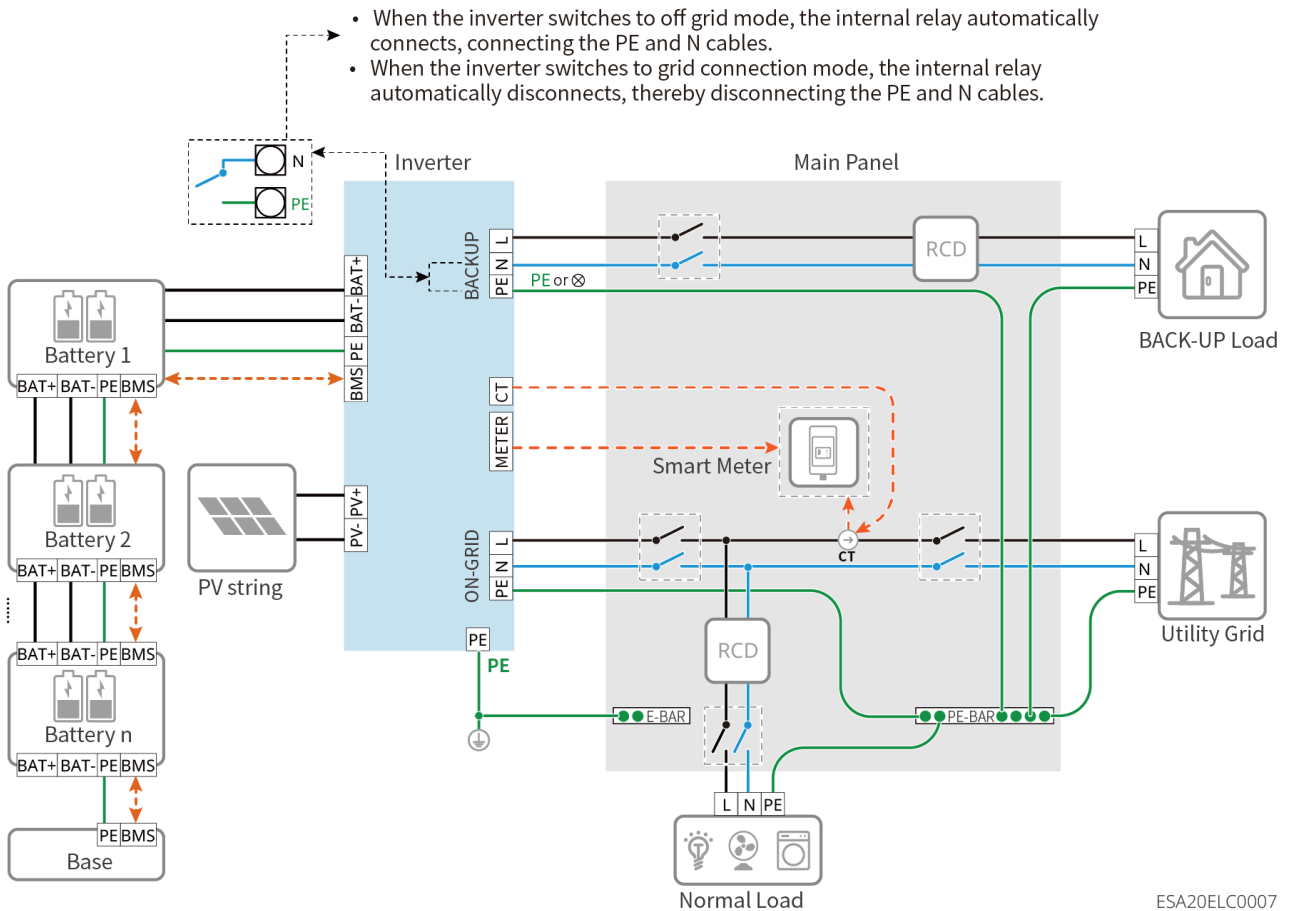

## 6.2 Detailed System Wiring Diagram

When all loads in a photovoltaic system are unable to consume the electricity generated by the system, the remaining electricity is fed into the grid. At this point, a smart meter or a CT can be used in conjunction to monitor the system's power generation and control the amount of electricity fed into the grid.

- Connecting a smart meter enables the functions of output power limitation and load monitoring.
- After connecting a smart meter, please enable the on-grid power limitation function via the SolarGo App.

In the single-unit system wiring diagram, only some models of equipment are used for wiring demonstration. Please perform wiring according to the actual equipment in use and refer to the corresponding wiring guide chapter.

## Notice

- When implementing load monitoring functions in microgrids and coupled scenarios, a dual-meter network must be used.
  - Electric meter 1 or built-in electric meter is used for system output power limitation.
  - Electricity meter 2 is used for load monitoring.
  - By integrating the data from Meter 1 and Meter 2, the monitoring platform can realize real-time monitoring of the load's power consumption.
- In microgrid scenarios, only one energy storage inverter is supported for use in the system.
- If output power limitation is required for the grid-connected inverter, please connect a separate device such as a smart meter or CT.
- Microgrid scenarios and coupled scenarios are paired with dual electricity meters, and the wiring methods for the meters are consistent.
- When not using integrated smart meter, do not connect the CT port of the inverter.
- Manual conversion switches are optional. Please choose whether to install them based on the actual usage scenario. If you have your own ATS or STS switch, this switch must have an interlock function.

### Dual electricity meter pairing scenario

Smart Meter 1 (Grid end)	Smart Meter 2 (AC side of on-grid Inverter)
Integrated Meter (Single inverter)	GMK110
Integrated Meter (Single inverter)	GM330
GMK110	GMK110
GM330	GM330
GMK110	GM330
GM330	GMK110

## 6.2.1 Detailed System Wiring Diagram for Single Inverter

## General Scenario

With integrated smart meter scenarios

Connection to a generator is not supported.

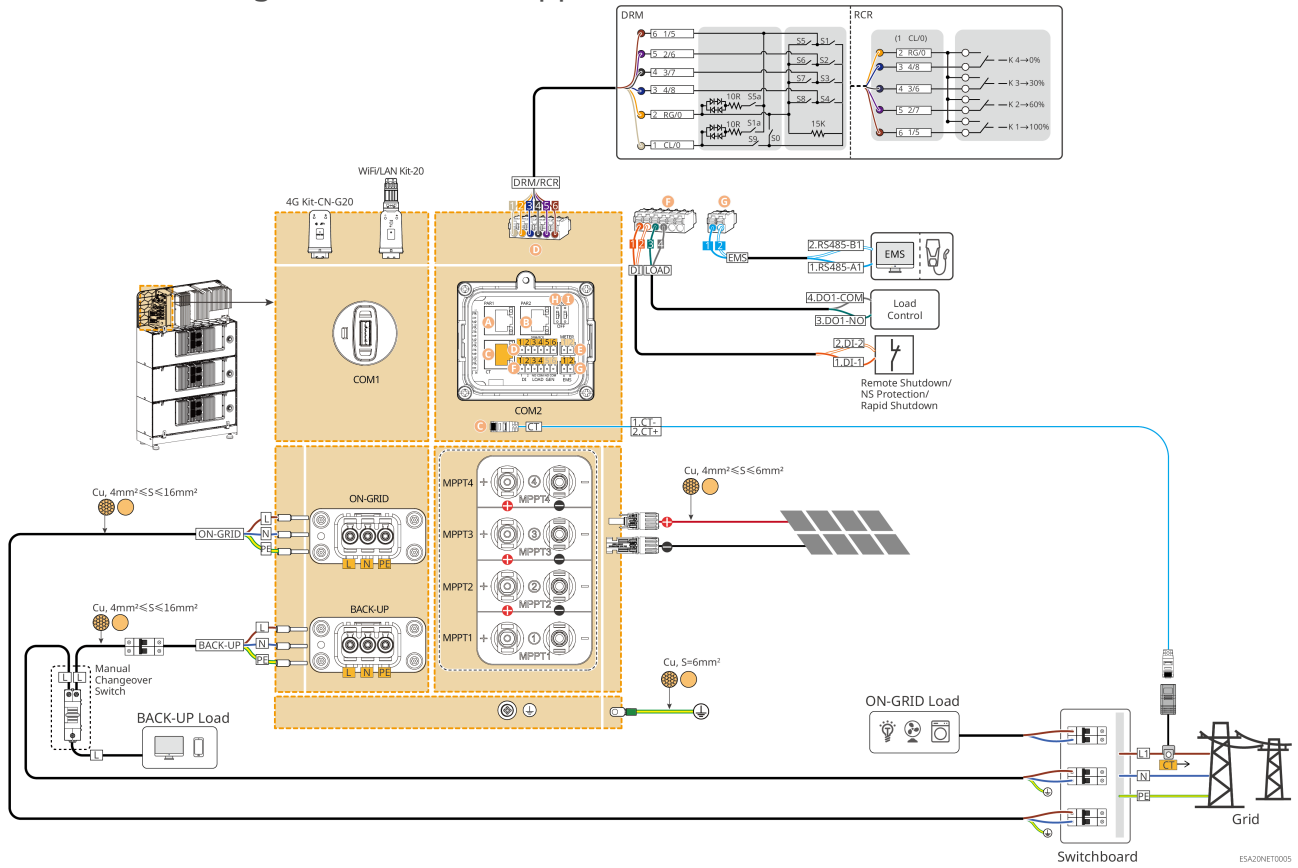

With GMK110 Smart Meter

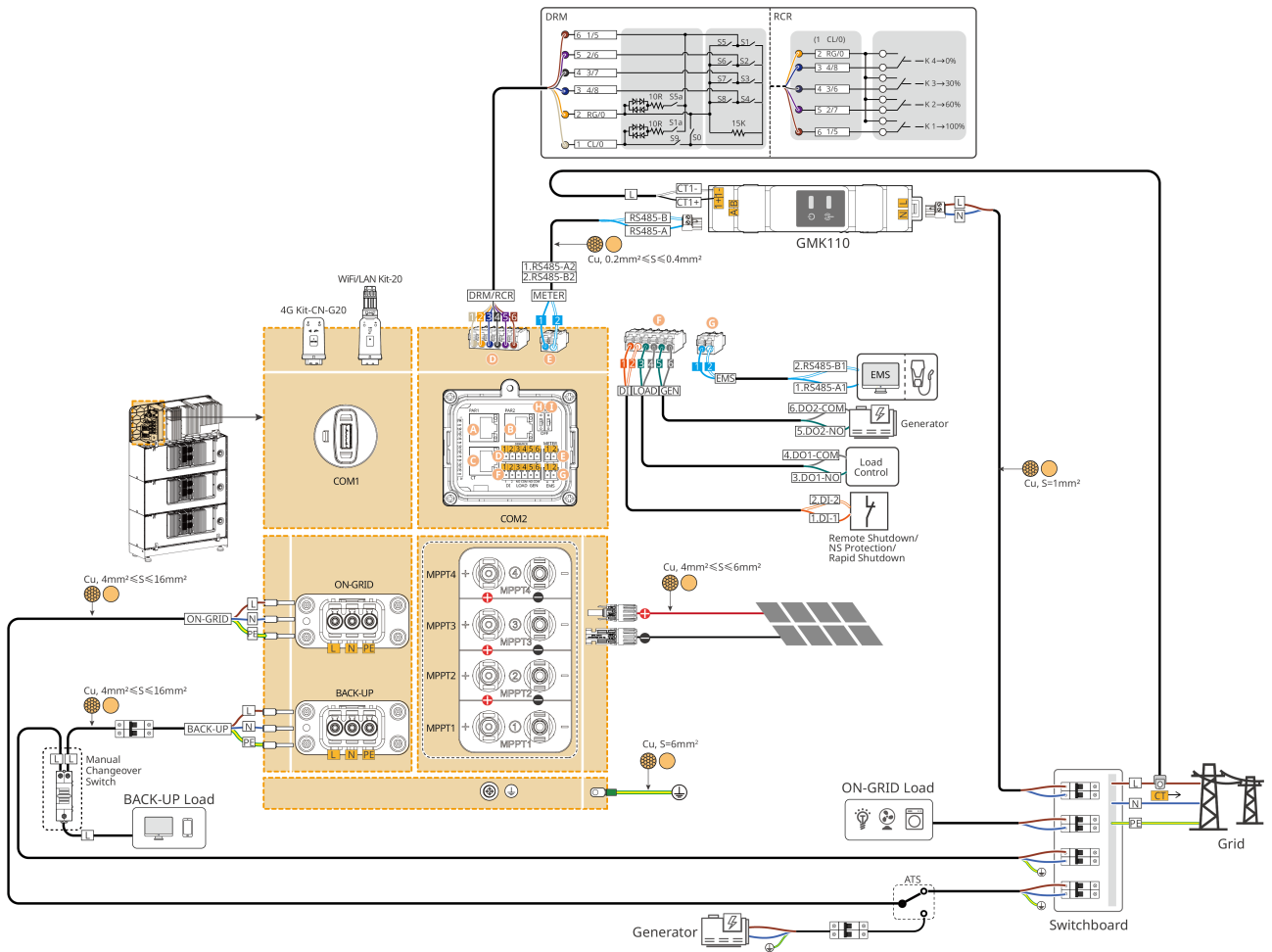

ESA0NET0002

With GM330 Smart Meter

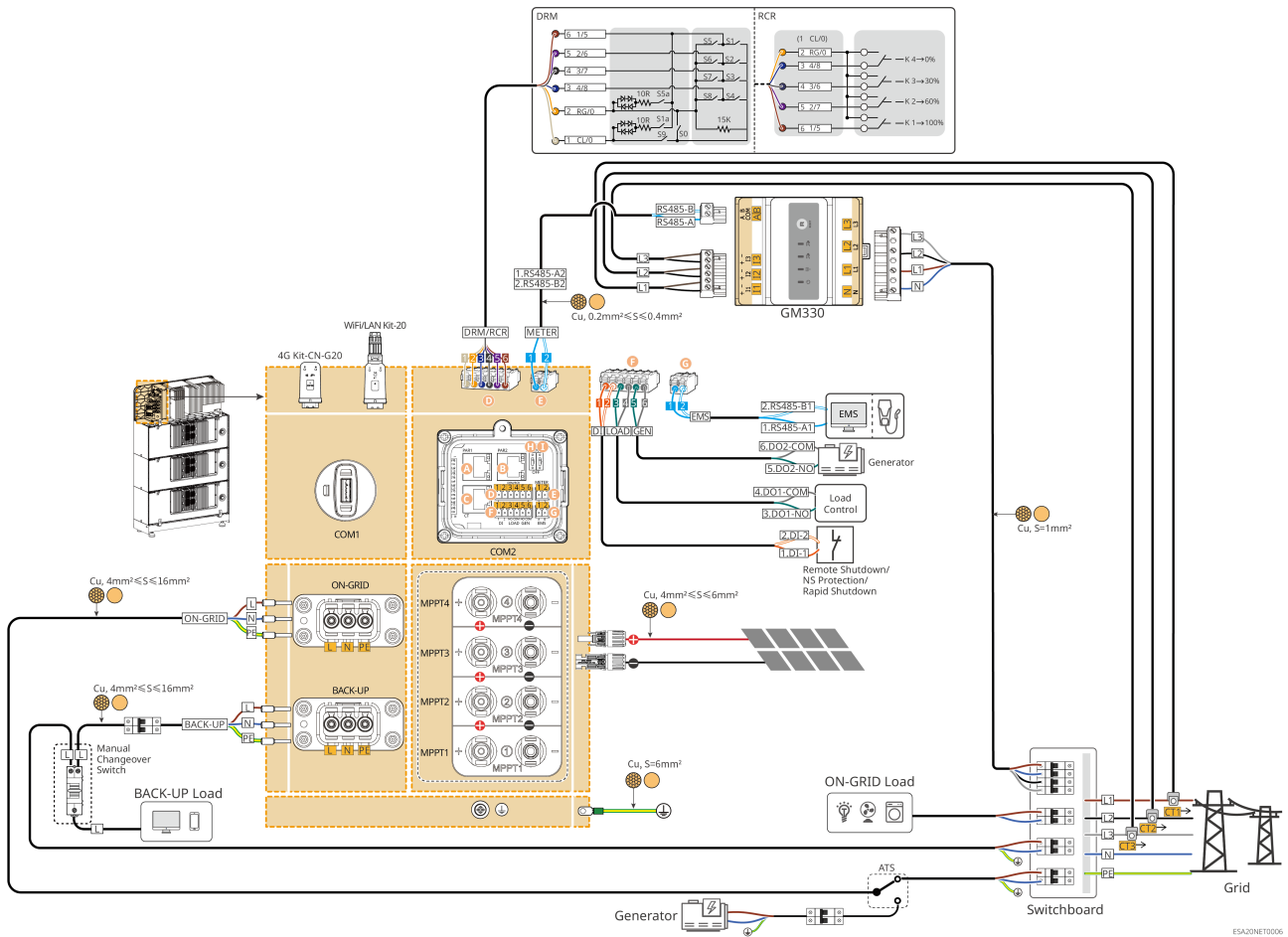

## Microgrid Scenario

- In microgrid scenarios, connection to a generator is not supported.
- Manual conversion switches are optional. Please choose whether to install them based on the actual usage scenario.

## Integrated Smart Meter+GM330 Smart Meter Networking Diagram

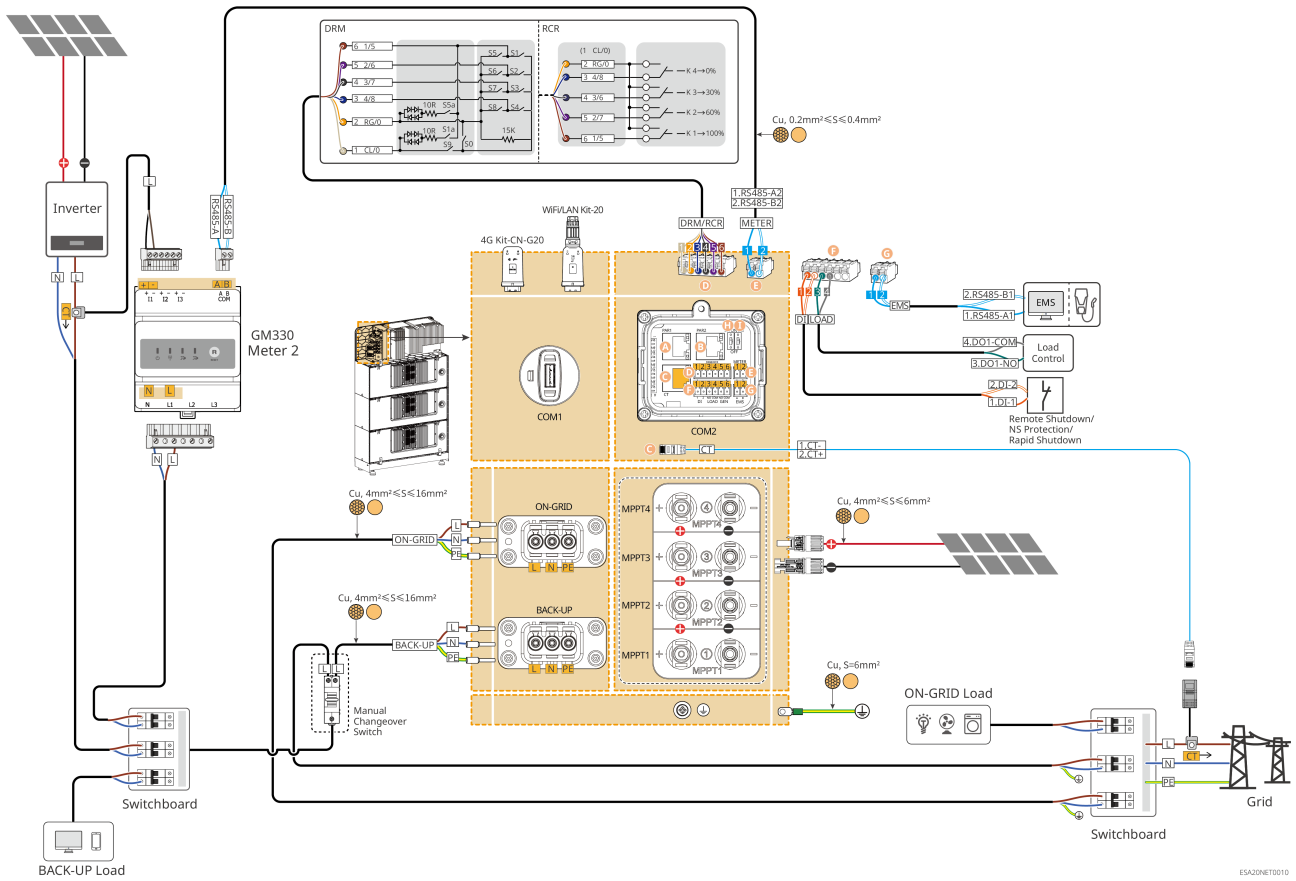

GMK110+GMK110 Networking Diagram

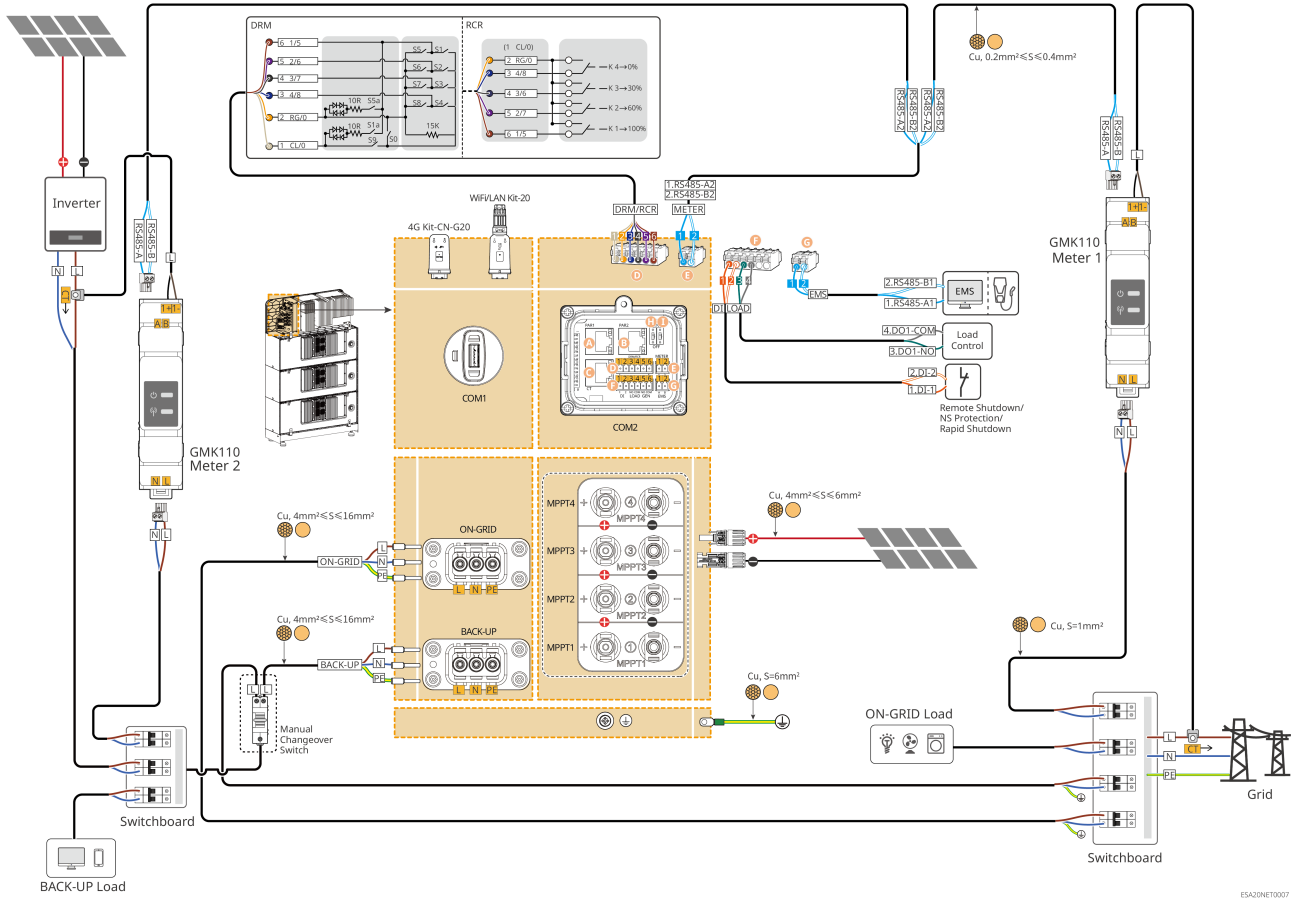

**Microgrid Scenario. On-grid Inverter Power Limitation Networking Diagram**

If output power limitation is required for the on-grid inverter, please connect a separate device such as a smart meter or CT.

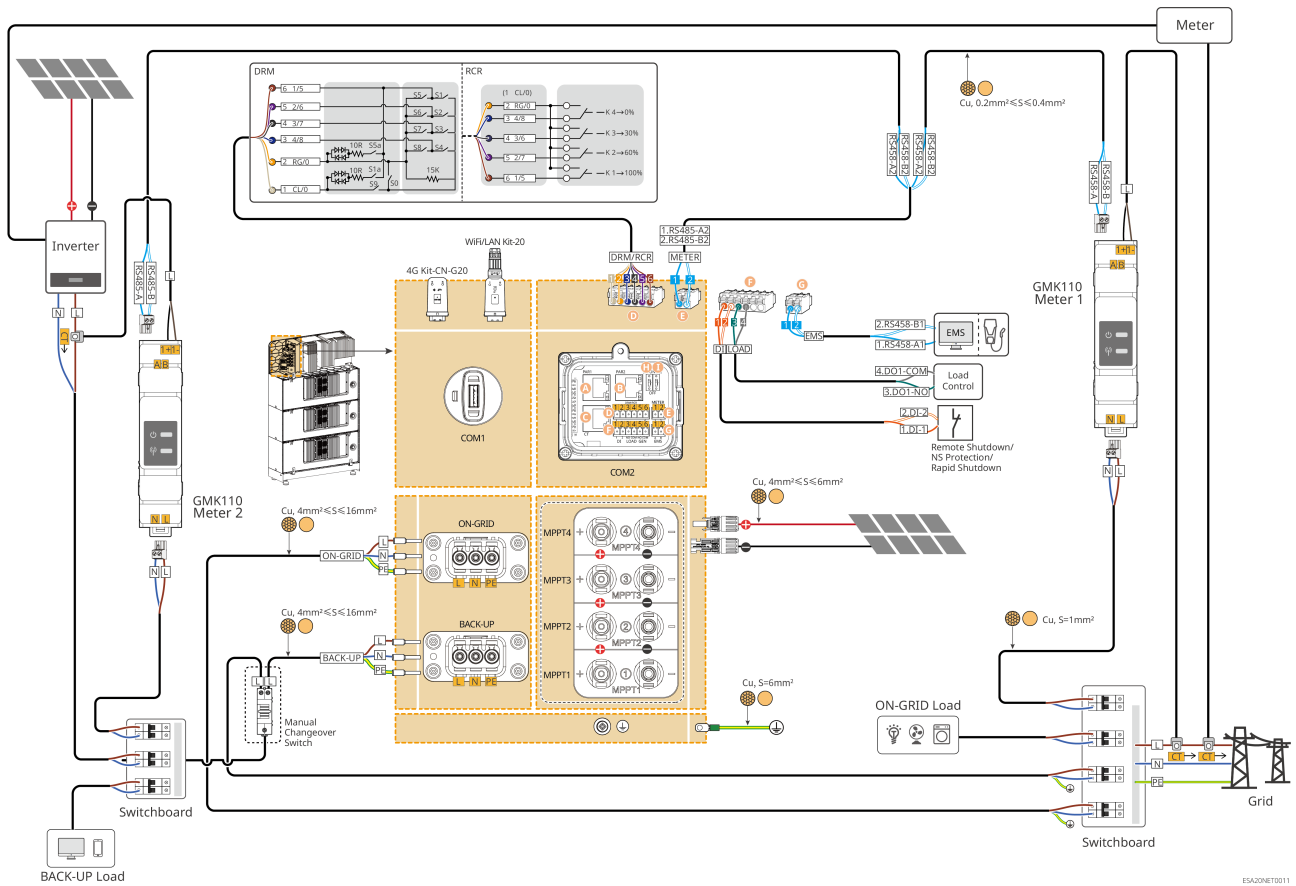

### Coupled Scenario. Dual Smart Meter Networking Diagram

- Manual conversion switches are optional. Please choose whether to install them based on the actual usage scenario.
- Connection to a generator is not supported.

### Integrated Smart Meter+GMK110 Smart Meter Networking Diagram

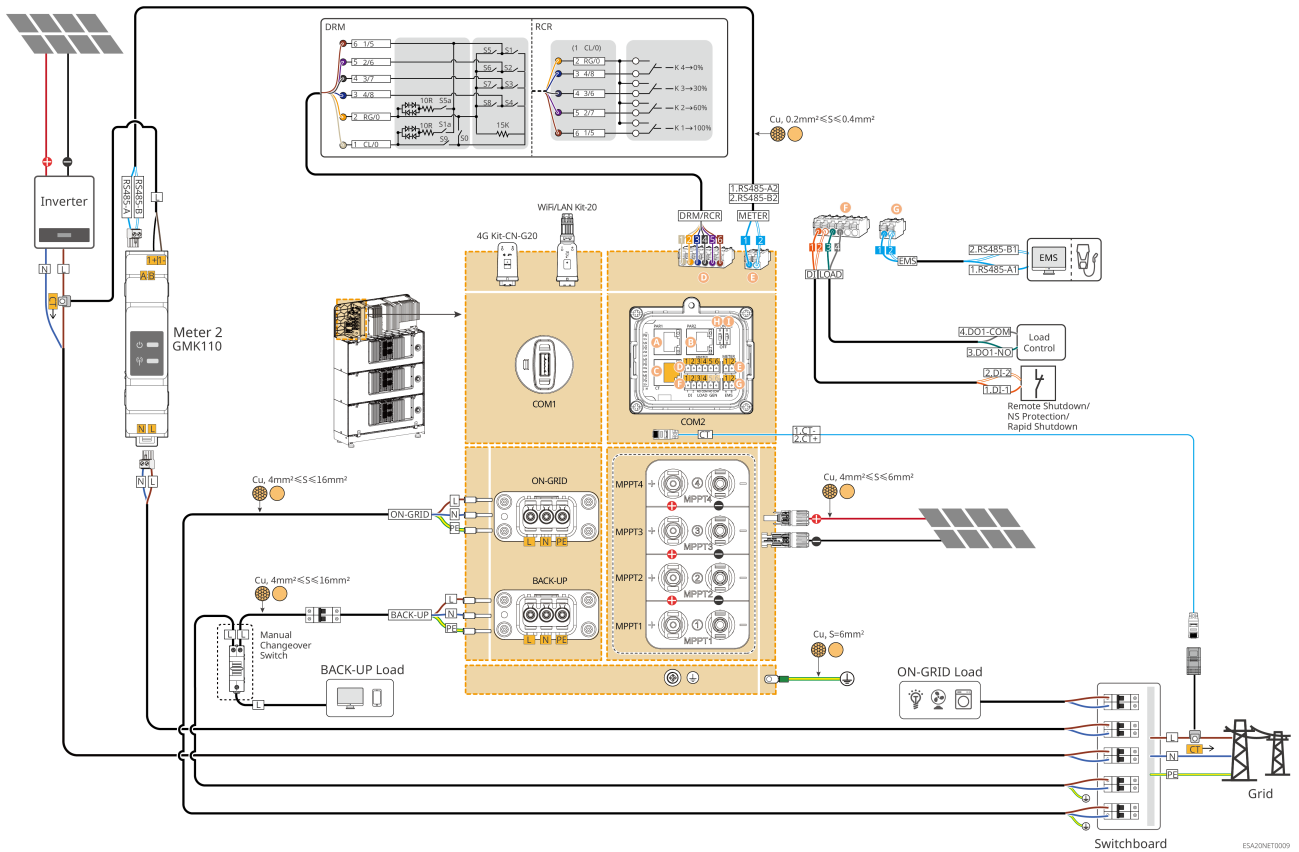

## GM330+GM330 Networking Diagram

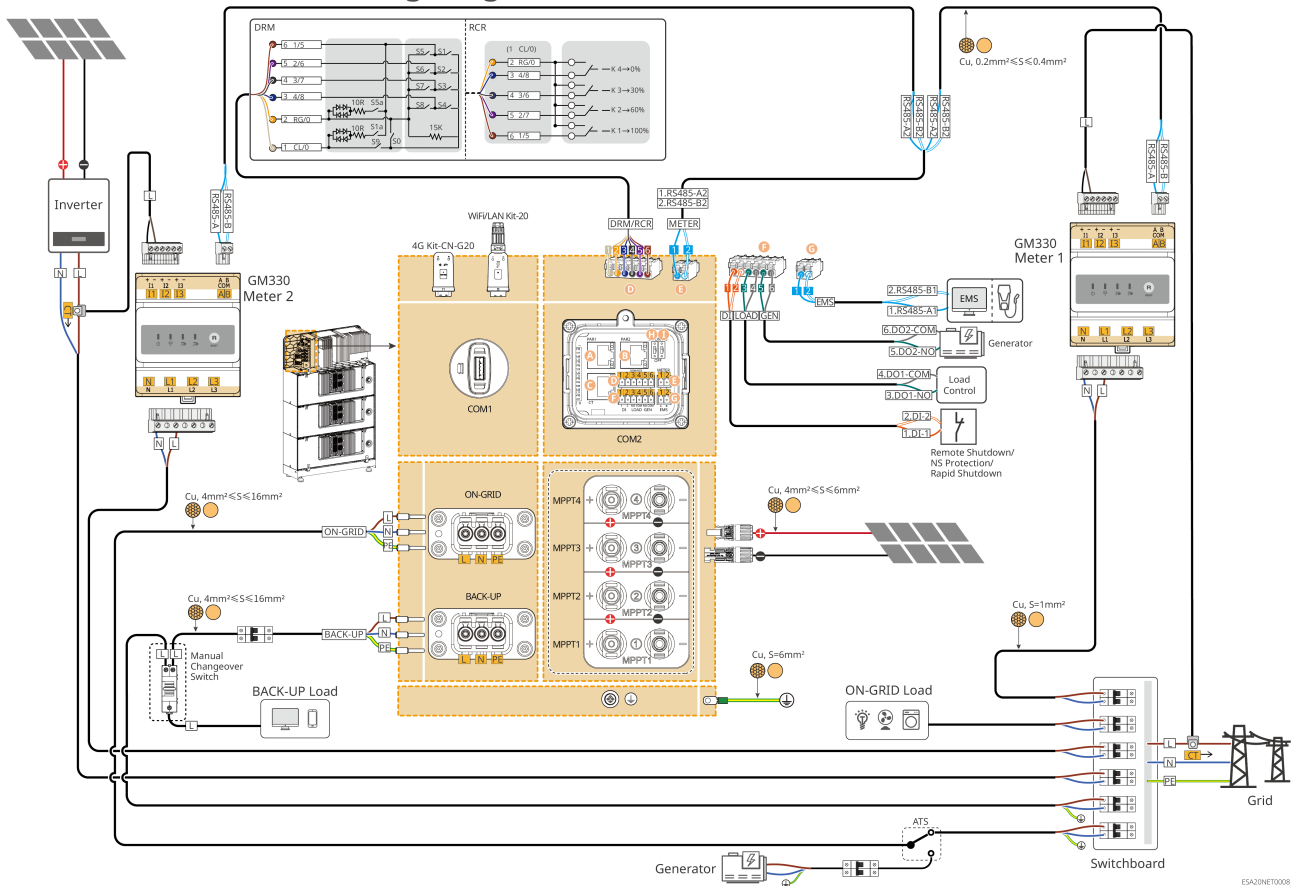

## Coupled Scenario. On-grid Inverter Power Limitation Networking Diagram

In the coupled scenario, if output power limitation is required for the on-grid inverter, please connect a separate device such as a smart meter or CT.

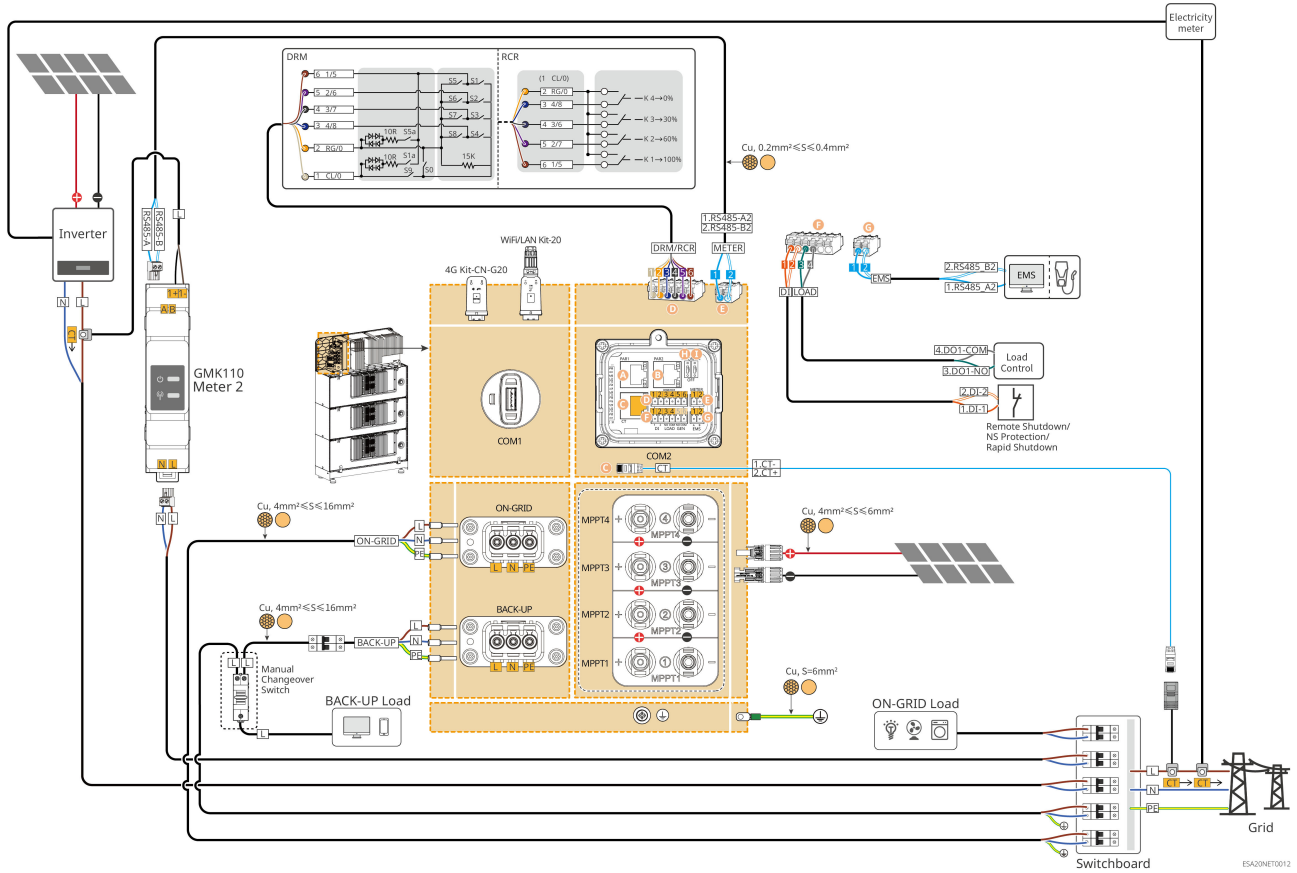

## 6.2.2 Detailed System Wiring Diagram for Parallel System

## NOTICE

- If devices such as DRED equipment, RCR equipment, remote shutdown equipment, NS Protection, and SG Ready heat pumps need to be connected in the system, please connect them to the main inverter.
- Remote shutdown/NS Protection Function: please connect the communication cable to the master inverter. Rapid shutdown function: please connect the communication cable to each inverter respectively. If the rapid shutdown function and remote shutdown/NS protection function need to be used at the same time, please contact the after-sales service center.
- The GM330 Smart Meter is standard for 2 or more inverters are paralleled.
- The following diagram mainly introduces parallel connections. For other port connections, refer to the single system.

In parallel scenarios, the inverter connected to the Ezlink and smart meter is considered as the master inverter, while all the others are slavery inverters. The master inverter must be set as the master unit through the parallel system settings in the **"SolarGo App"**. For specific settings, please refer to [9.2.6."Setting Up the RS485 Parallel System"\(Page 152\)](#).

### **General Scenarios**

With GMK110 scenarios

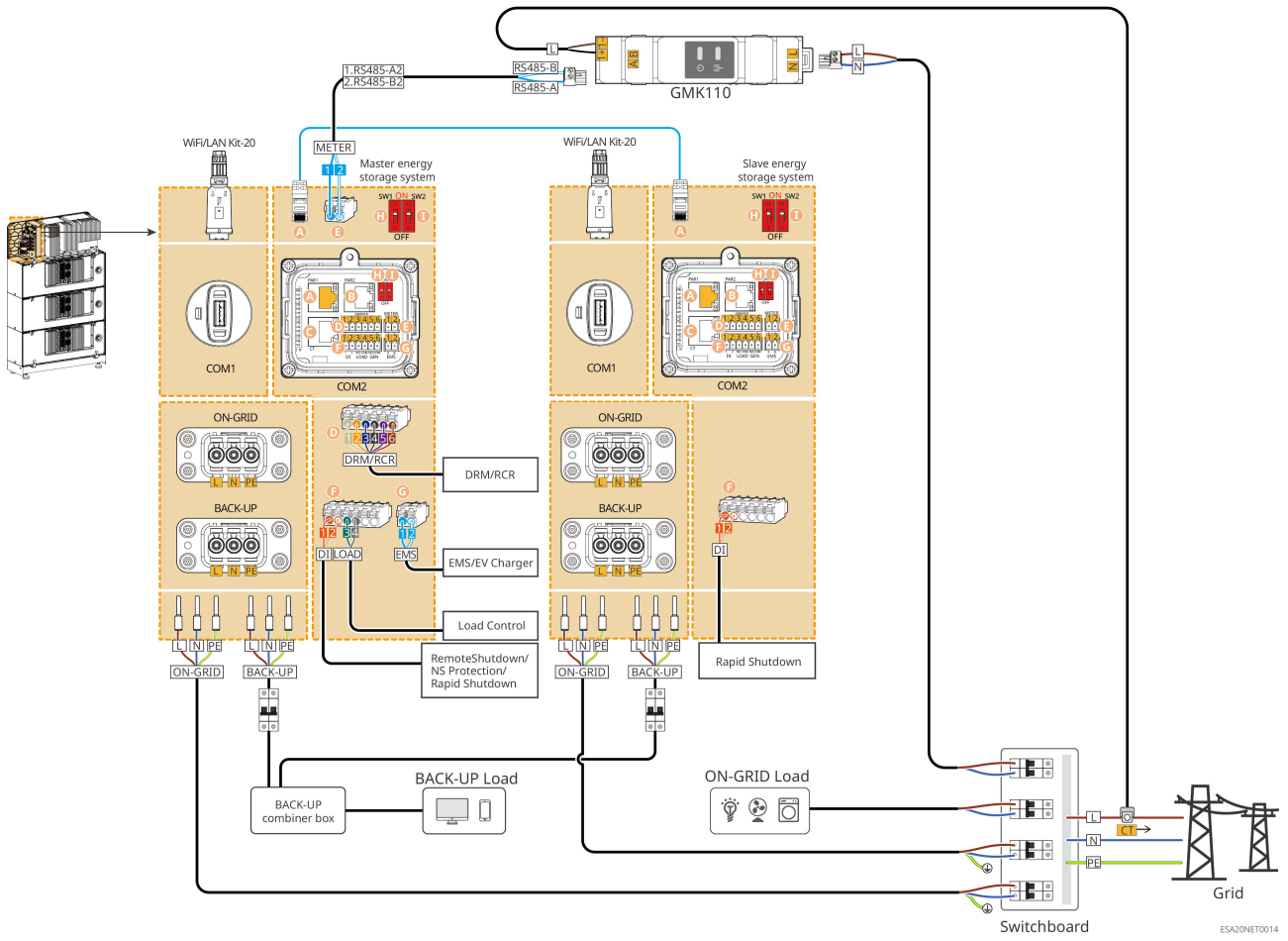

With GM330 scenarios

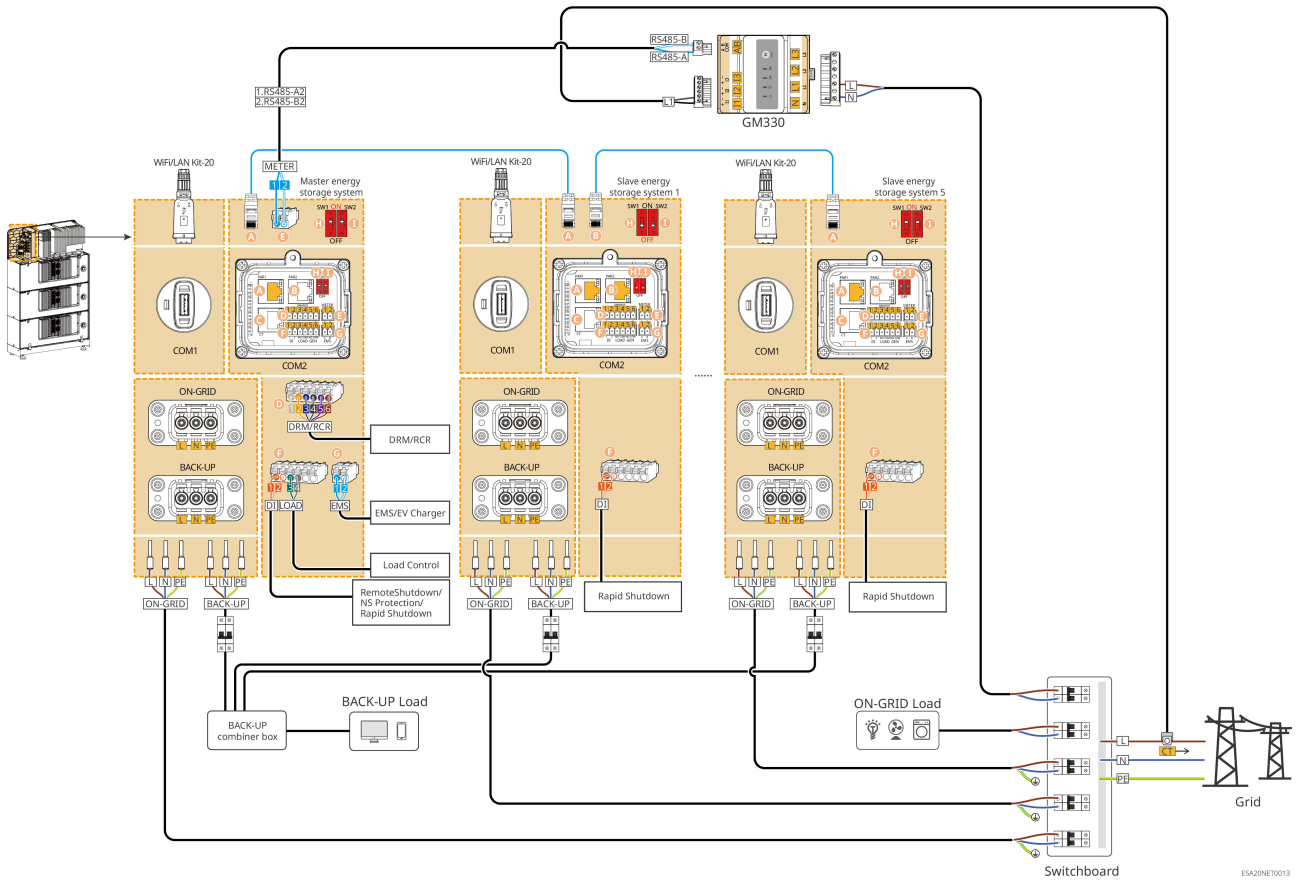

**Coupled Scenarios**  
 GM330+GM330 Networking Diagram

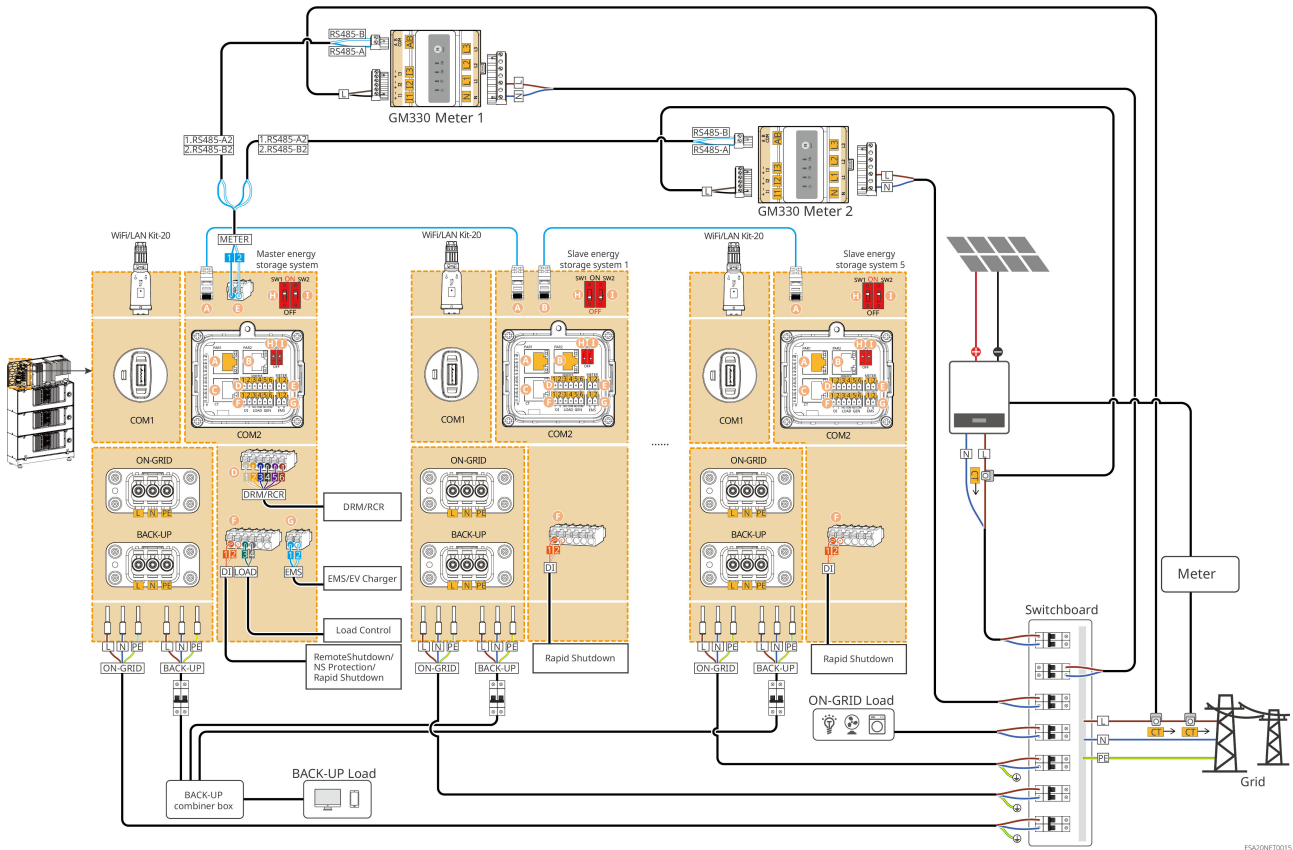

In the coupled system scenarios, the paralleling wiring method for the configuration with GMK110 can refer to the scenario of configuring GMK110 in the general paralleling scenario; the wiring method for the grid-connected inverter can refer to the single-unit coupling scenario for wiring.

## 6.3 Preparing Materials



- Do not connect loads between the inverter and the AC switch directly connected to the inverter.
- Install one AC output circuit breaker for each inverter. Multiple inverters cannot share one AC circuit breaker.
- An AC circuit breaker shall be installed on the AC side to make sure that the inverter can safely disconnect the grid when an exception happens. Select the appropriate AC circuit breaker in compliance with local laws and regulations.
- When the inverter is powered on, the BACK-UP AC port is charged. Power off the inverter first if maintenance is required on the BACK-UP loads. Otherwise, it may cause electric shock.
- For cables used in the same system, it is recommended that the conductor material, cross sectional area, length, etc. of the cables should be consistent.
  - The AC cable for BACK-UP port of each inverter
  - The AC cable for ON-GRID port of each inverter
- In single inverter scenario, the inverter supports connection to a generator via an ATS switch, enabling switching between grid and generator power supply. The ATS switch is connected to the power grid by default.

### 6.3.1 Preparing Breakers

No.	Circuit breaker	Recommended specifications	Acquisition method	Comment
1	ON-GRID circuit breaker BACK-UP circuit breaker	<p>The partial power scenario are recommended as follows:</p> <ul style="list-style-type: none"> <li>• Nominal Voltage <math>\geq 230\text{Vac}</math></li> <li>• The rated current requirements are as follows:               <ul style="list-style-type: none"> <li>◦ GW3K-EHA-G20 : 20A</li> <li>◦ GW3.6K-EHA-G20 : 20A</li> <li>◦ GW5K-EHA-G20 : 32A</li> <li>◦ GW6K-EHA-G20 : 40A</li> <li>◦ GW8K-EHA-G20 : 50A</li> <li>◦ GW9.999K-EHA-G20 : 63A</li> </ul> </li> </ul>	Prepared by customers	When selecting a circuit breaker, you can also choose one that meets local installation regulations based on the actual working current.

No.	Circuit breaker	Recommended specifications	Acquisition method	Comment
		<ul style="list-style-type: none"> <li>◦ GW10K-EHA-G20 : 63A</li> </ul> <p>The whole-house backup power scenario are recommended as follows:</p> <ul style="list-style-type: none"> <li>• Nominal Voltage<math>\geq</math>230Vac</li> <li>• The rated current requirements are as follows:               <ul style="list-style-type: none"> <li>◦ GW3K-EHA-G20 : 40A</li> <li>◦ GW3.6K-EHA-G20 : 40A</li> <li>◦ GW5K-EHA-G20 : 63A</li> <li>◦ GW6K-EHA-G20 : 63A</li> <li>◦ GW8K-EHA-G20 : 63A</li> <li>◦ GW9.999K-EHA-G20 : 63A</li> <li>◦ GW10K-EHA-G20 : 63A</li> </ul> </li> </ul> <p>Note: If the inverter's BACK-UP port is not used, the ON-GRID circuit breaker can be selected according to the maximum grid-connected current.</p>		
2	ATS switch	The load breaker specifications for the ATS and ON-GRID for one inverter model shall be the same.	Prepared by customers	Single inverter only

No.	Circuit breaker	Recommended specifications	Acquisition method	Comment
3	Residual Current Protector (RCD)	<p>RCD device installation and RCD specification selection: It is recommended to connect an A-type RCD with a residual current trip threshold of <math>\geq 300\text{mA}</math> to the AC output side of the inverter (for inverters with a capacity <math>&lt; 30\text{kVA}</math>, the residual current trip threshold should be selected as <math>300\text{mA}</math>; for inverters with a capacity <math>\geq 30\text{kVA}</math>, the residual current trip threshold should be selected as <math>10\text{mA/kVA}</math>). Alternatively, the appropriate RCD specifications may be selected in accordance with local regulatory requirements.</p>	Prepared by customers	-
4	(Optional) Manual conversion switch	<ul style="list-style-type: none"> <li>• Nominal Voltage <math>\geq 230\text{Vac}</math></li> <li>• Nominal Current: <math>63\text{A}</math></li> </ul>	Prepared by customers Shipped with inverter. (Only for Australia)	Integrated Meter (Single inverter)

### 6.3.2 Preparing Cables

No.	Cable	Recommended specifications	Acquisition method
1	Inverter PE cable	<ul style="list-style-type: none"> <li>• Single-core outdoor copper cable</li> <li>• Cross-sectional area: <math>S=5.2\text{mm}^2</math>-<math>6\text{mm}^2</math></li> </ul>	Prepared by customers
2	PV DC cable	<p>Only for EHA model:</p> <ul style="list-style-type: none"> <li>• Commonly used outdoor photovoltaic cable</li> <li>• Cross-sectional area: <math>4\text{mm}^2</math>-<math>6\text{mm}^2</math></li> <li>• Outer diameter: 5.9mm-8.8mm</li> </ul>	Prepared by customers
3	AC cable	<ul style="list-style-type: none"> <li>• AC input and output cables of inverter (BACK UP/ ON GRID):</li> <li>• Cross-sectional area: <math>4\text{mm}^2</math>-<math>16\text{mm}^2</math> <ul style="list-style-type: none"> <li>◦ GW3K-EHA-G20, GW3.6K-EHA-G20: <math>4\text{mm}^2</math>-<math>6\text{mm}^2</math></li> <li>◦ GW5K-EHA-G20, GW6K-EHA-G20: <math>6\text{mm}^2</math>-<math>10\text{mm}^2</math></li> <li>◦ GW8K-EHA-G20, GW9.999K, EHA-G20, GW10K-EHA-G20: <math>10\text{mm}^2</math>-<math>16\text{mm}^2</math></li> </ul> </li> <li>• Outer diameter of multi-core outdoor copper cable: 10mm-21mm</li> </ul>	Prepared by customers
4	Smart meter power cable	<ul style="list-style-type: none"> <li>• Outdoor copper cable</li> <li>• Conductor Cross-sectional area: <math>1\text{mm}^2</math></li> </ul>	Prepared by customers
5	Smart meter RS485 communication cable	<ul style="list-style-type: none"> <li>• Shielded twisted pair cable</li> <li>• Cross-sectional area: <math>0.2\text{mm}^2</math>-<math>0.4\text{mm}^2</math></li> </ul>	Prepared by customers

No.	Cable	Recommended specifications	Acquisition method
6	EMS or charging pile RS485 communication port		
7	Remote shutdown and NS Protection communication line	<ul style="list-style-type: none"> <li>• Shielded cable that meets local standards</li> <li>• Cross-sectional area: 0.2mm<sup>2</sup>-0.4mm<sup>2</sup></li> <li>• Outer diameter: 5mm-8mm</li> </ul>	Prepared by customers
8	Load control and generator control DO communication cable		
9	RCR/DRED signal cable		
10	CT communication cable	Standard Network Cable: CAT 5E or higher specification standard network cable and RJ45 connectors	Prepared by customers
11	Communication cable for parallel connected inverters	<ul style="list-style-type: none"> <li>• RJ45 crimping tool</li> <li>• Straight-through network cable of CAT 5E or higher specification <ul style="list-style-type: none"> <li>◦ The recommended length for CAT 5E or CAT 6E shall not exceed 5 meters.</li> <li>◦ The recommended length for CAT 7E shall not exceed 10 meters.</li> </ul> </li> </ul>	Prepared by customers

## 6.4 Connecting the PE Cable



- The PE cable connected to the enclosure of the inverter cannot replace the PE cable connected to the AC output port. Make sure that both of the two PE cables are securely connected.
- To improve the corrosion resistance of the terminal, you are recommended to apply silica gel or paint on the ground terminal after installing the PE cable.
- Connect the PE cable first before installing the equipment. Disconnect the PE cable before dismantling the equipment.
- The battery grounding is integrated into the blind-plug connector connected to the inverter. The system is uniformly grounded through the inverter, eliminating the need for separate battery grounding during installation.

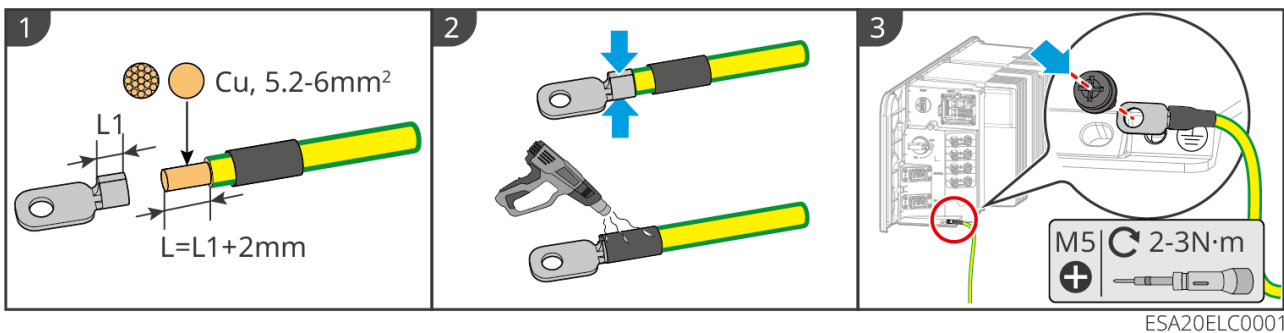

## 6.5 Connecting the PV cable

### DANGER

- Do not connect the same PV string to multiple inverters at the same time. Otherwise, the inverters may be damaged.
- Confirm the following information before connecting the PV string to the inverter. Otherwise, the inverter may be damaged permanently or even cause fire and cause personal and property losses.
  1. Make sure that the max short circuit current and the maximum input voltage per MPPT are within the permissible range.
  2. Make sure that the positive pole of the PV string connects to the PV+ of the inverter. And the negative pole of the PV string connects to the PV- of the inverter.

### WARNING

- The PV strings cannot be grounded. Ensure the minimum insulation resistance of PV string to the ground meets the minimum insulation resistance requirements before connecting the PV string to the inverter ( $R = \text{maximum input voltage} / 30\text{mA}$ ).
- Ensure the DC cables are connected tightly, securely and correctly.
- Measure the positive and negative terminals of the DC cable using a multimeter to avoid reverse polarity connection. Also, the voltage should be within the permissible range.

### NOTICE

- The two input strings per MPPT should be of the same type, the same number of PV panels, the same tilt and angle to ensure the best efficiency.

#### Type I:

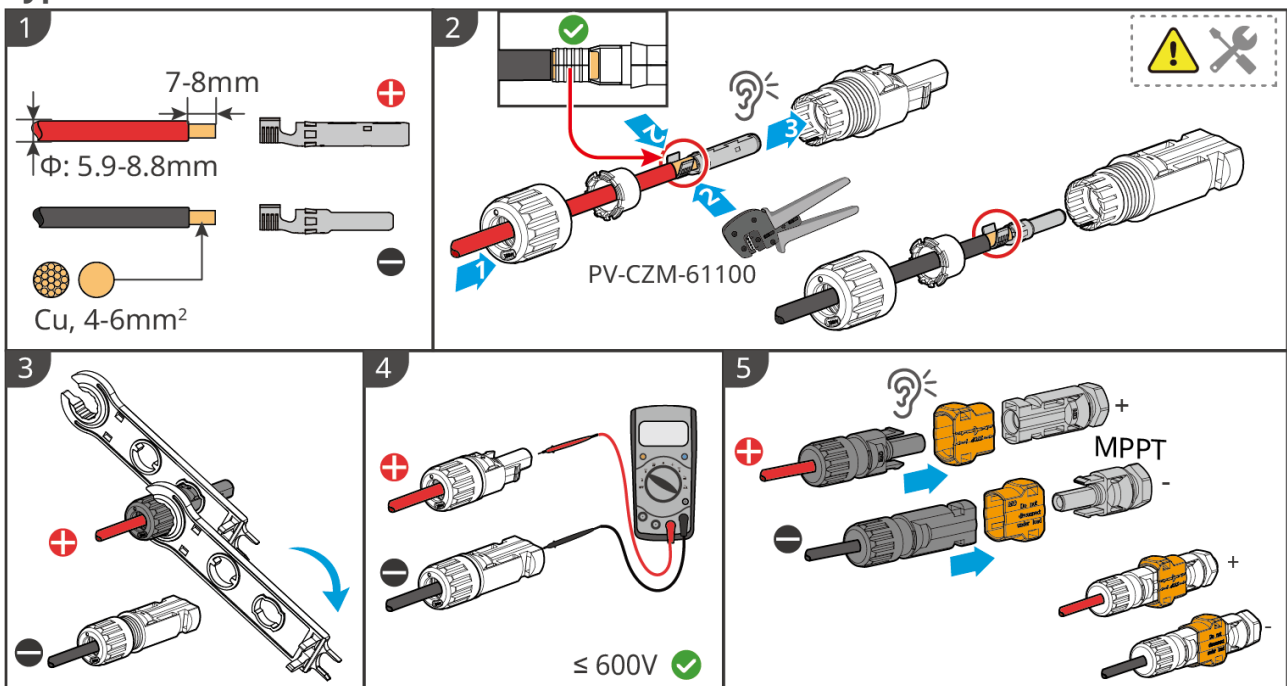

ESA20ELC0004

If disassembly of the PV terminal is required, please refer to the following steps:

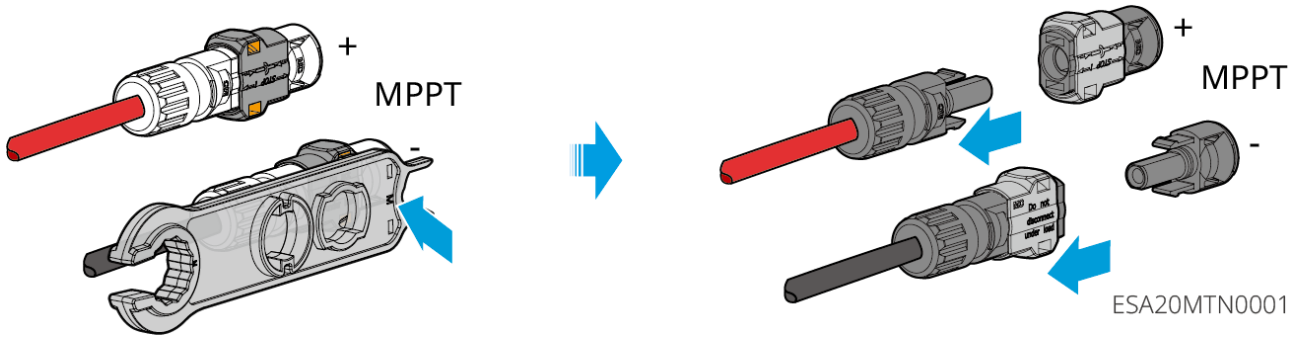

**Type II:**

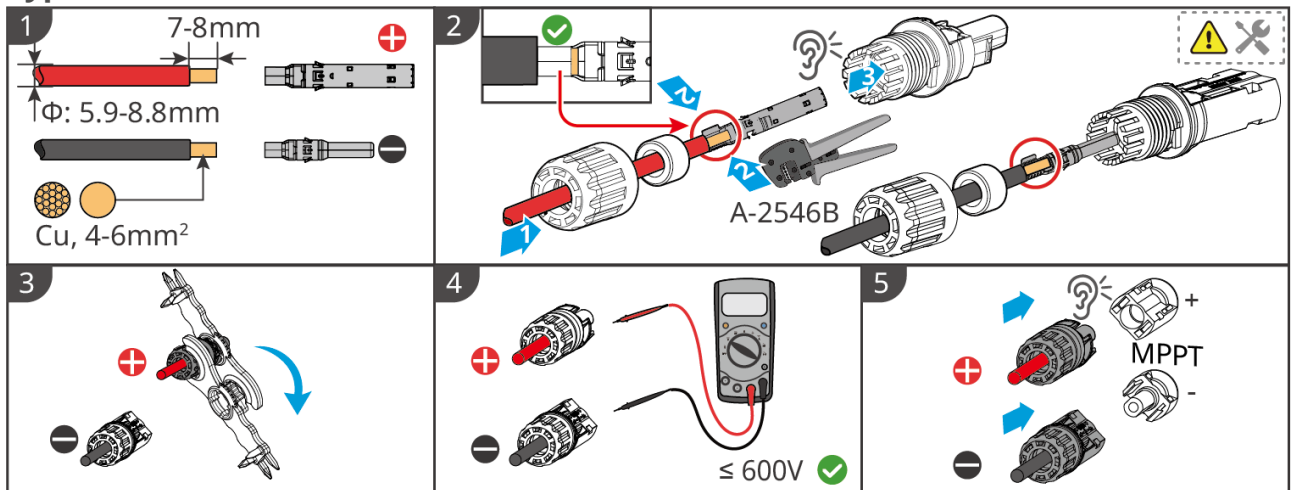

ESA20ELC0013

If disassembly of the PV terminal is required, please refer to the following steps:

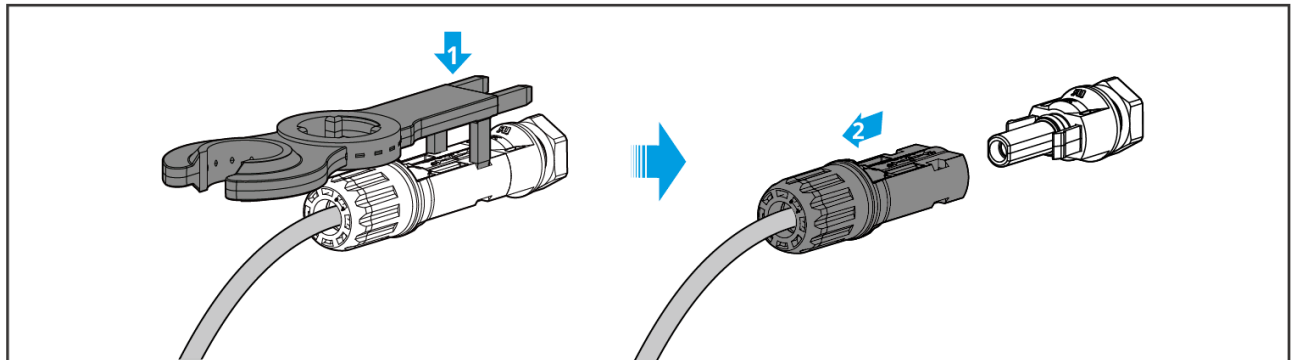

ESA20ELC0014

## 6.6 Connecting the AC Cable



- The residual current monitoring unit (RCMU) is integrated into the inverter to avoid the residual current exceeds the limit. The inverter will disconnect the utility grid quickly once it found the residual current exceeds the limit.
- Connect the AC cables to the corresponding terminals such as “BACKUP”, “ON-GRID” correctly. Otherwise it will cause damage to the inverter.
- Ensure that the whole cable cores are inserted into the terminal holes, and no part of the cable core can be exposed.
- Ensure that the insulation board is inserted into the AC terminal tightly.
- Ensure that the cables are connected securely. Otherwise it will cause damage to the inverter due to overheat during its operation.

A: GW3K-EHA-G20, GW3.6K-EHA-G20

B: GW5K-EHA-G20, GW6K-EHA-G20

C: GW8K-EHA-G20, GW9.999K-EHA-G20, GW10K-EHA-G20

### Type I:

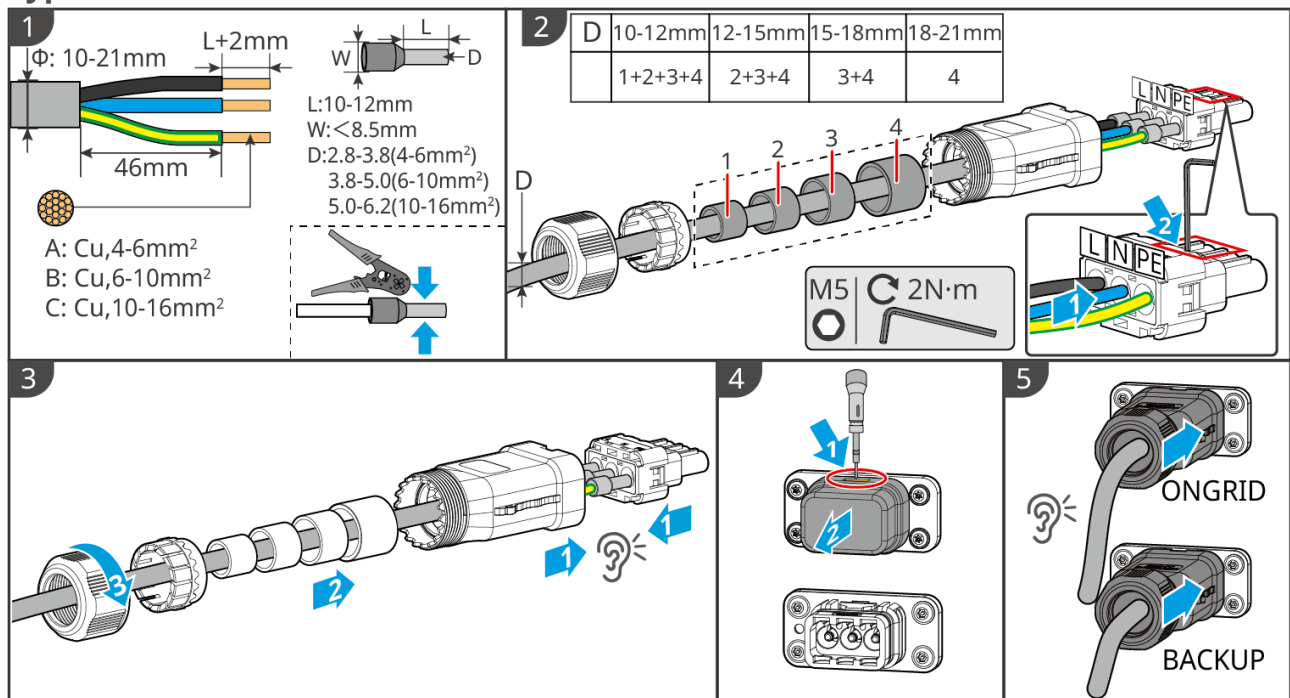

If disassembly of the AC terminal is required, please refer to the following steps:

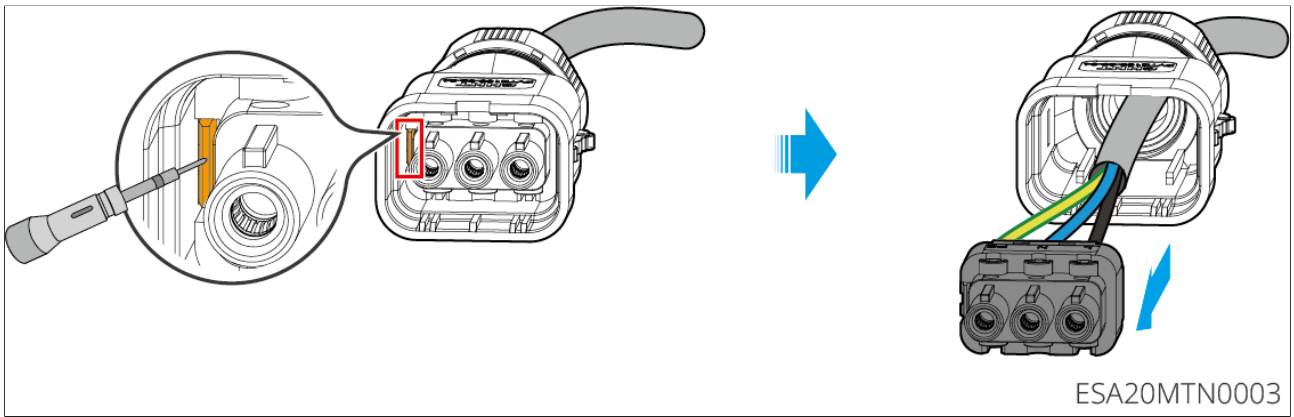

### Type II:

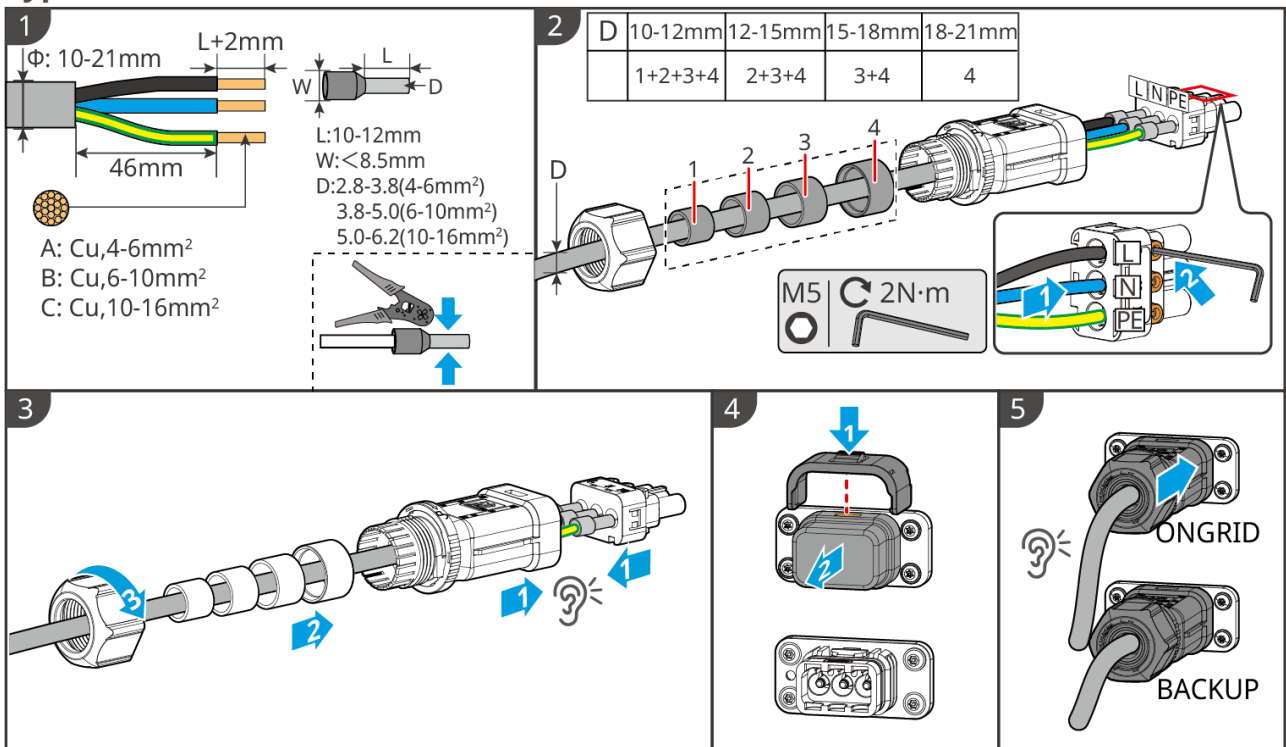

ESA20ELC0011

If disassembly of the AC terminal is required, please refer to the following steps:

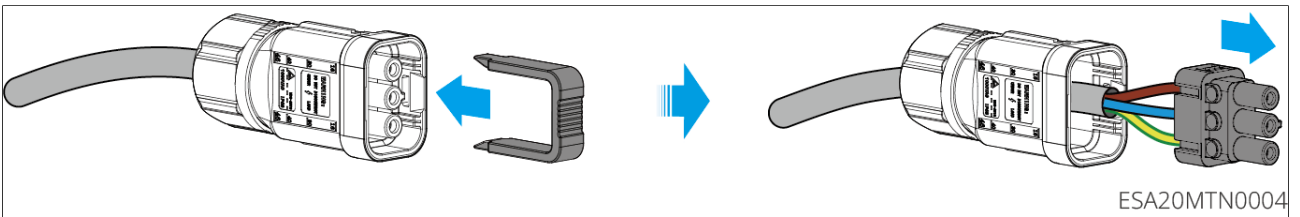
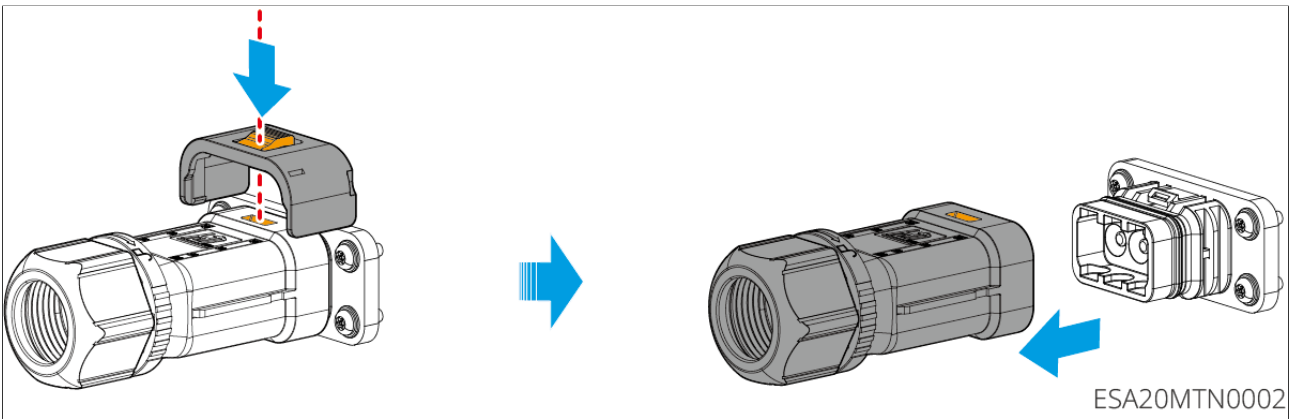

**(Optional) Connect manual conversion switch**

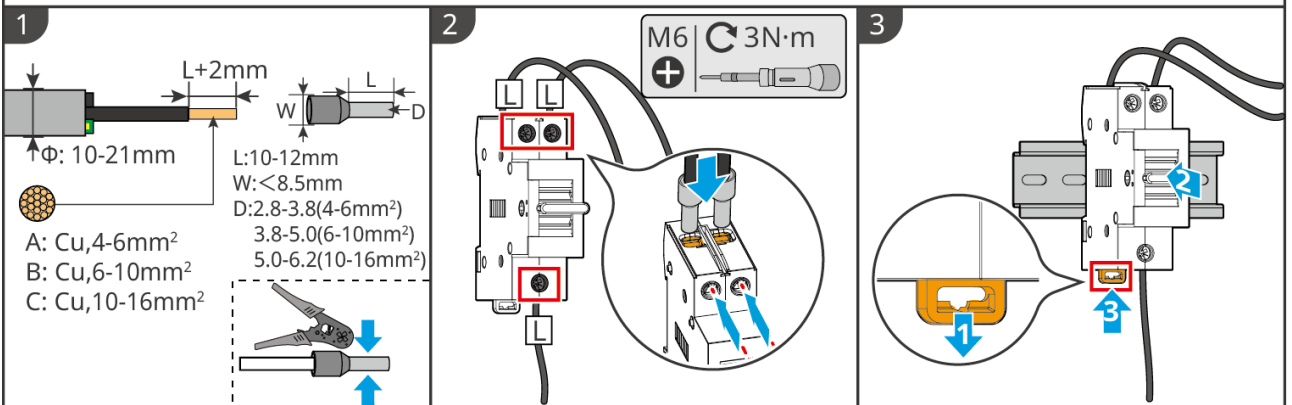
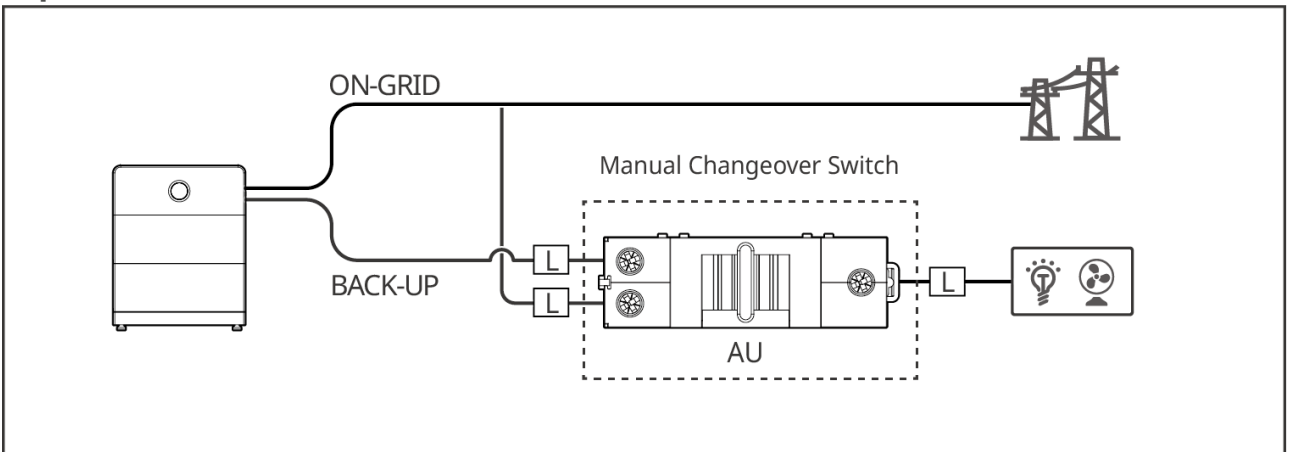

ESA20ELC0003

**6.7 Connecting the Meter Cable**

## NOTICE

- Contact the manufacturer for additional smart meters if multiple inverters are connected.
- Ensure that the CT is connected in the correct direction and phase sequences, otherwise the monitoring data will be incorrect.
- Ensure all cables are connected tightly, securely, and correctly. Inappropriate wiring may cause poor contacts or high impedances, and damage the inverter.
- In areas at risk of lightning, if the meter cable exceeds 10m and the cables are not wired with grounded metal conduits, you are recommended to use an external lightning protection device.

### Wiring of GMK110

## NOTICE

- Outer diameter of the AC cable should be smaller than the holes diameter of the CT, so that the AC cable can be routed through the CT.
- To ensure accurate current detection, the CT cable is recommended to be shorter than 30m.
- Do not use network cable as the CT cable, otherwise the smart meter may be damaged due to high current.
- The CTs vary slightly in dimensions and appearance depending on the model, but they are installed and connected in the same way.

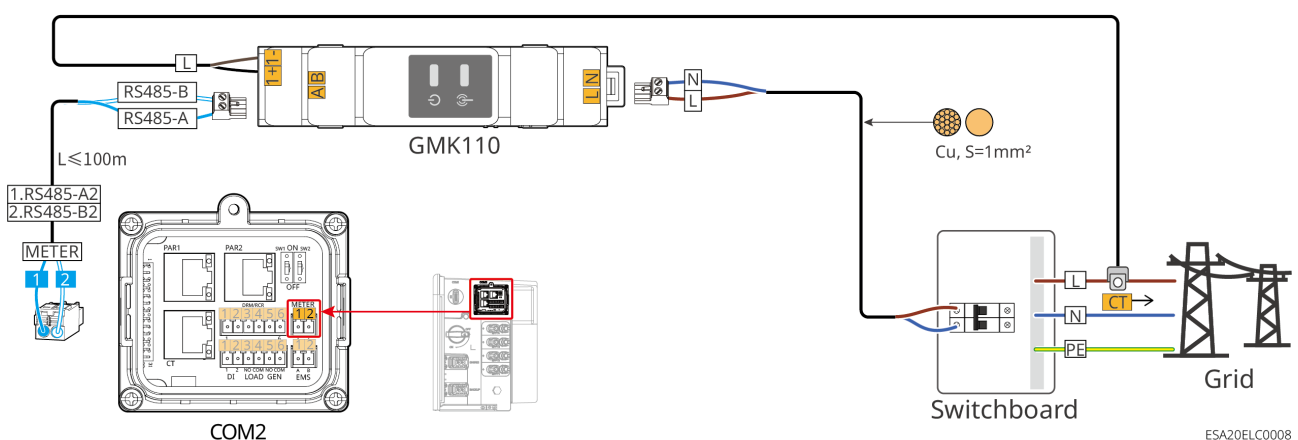

### Connection steps

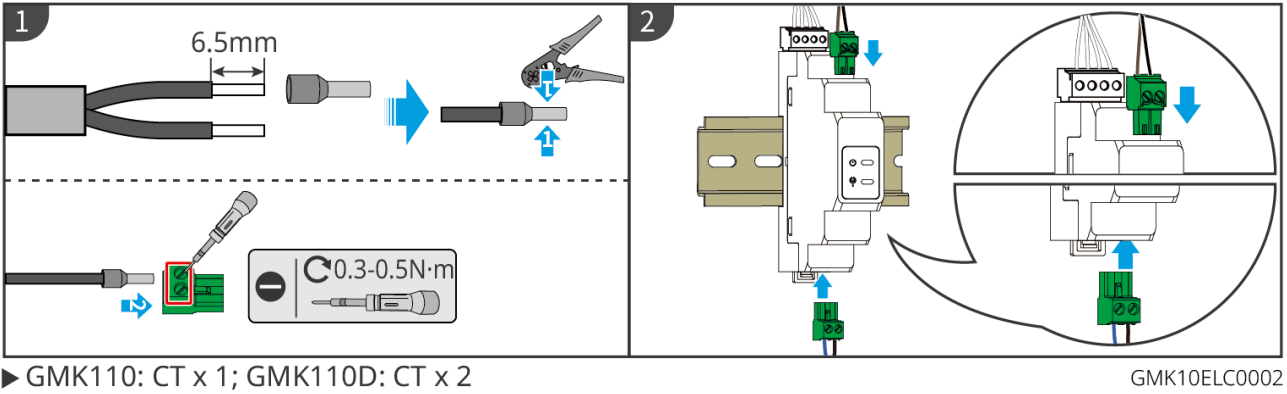

### Wiring of GM330 smart meter

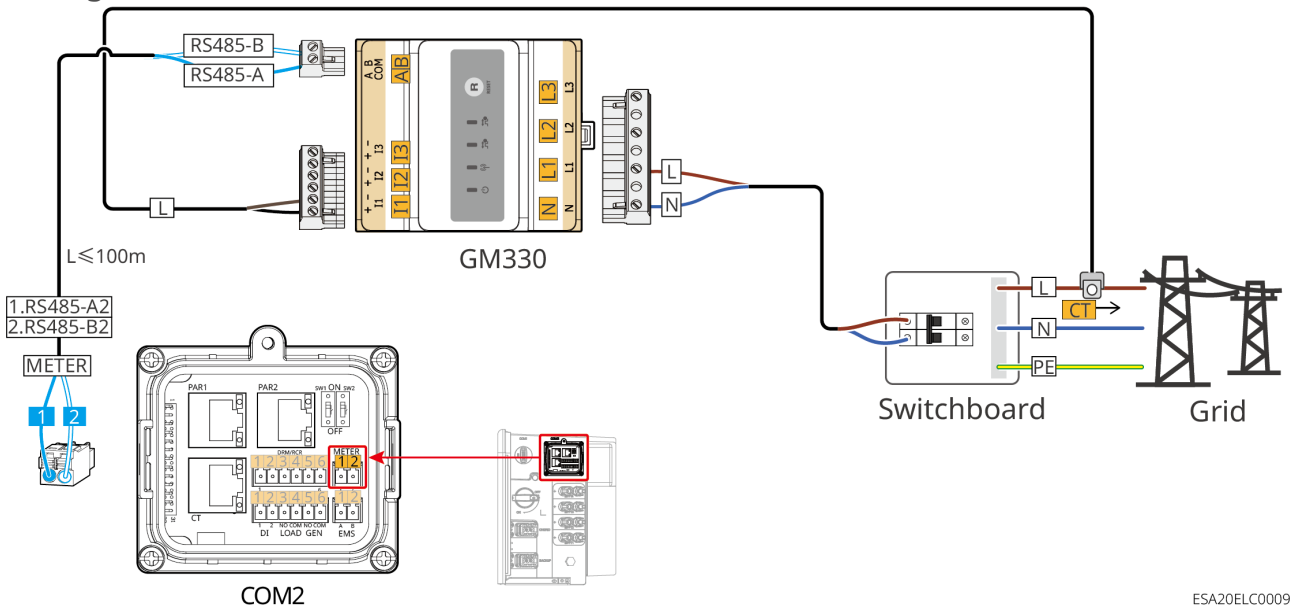

### Connection steps

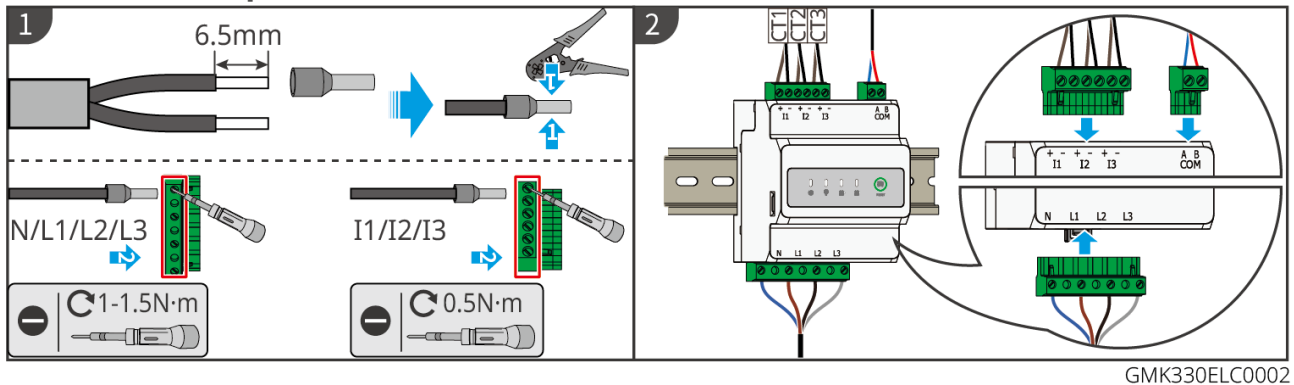

### Installing the CT (Type I)

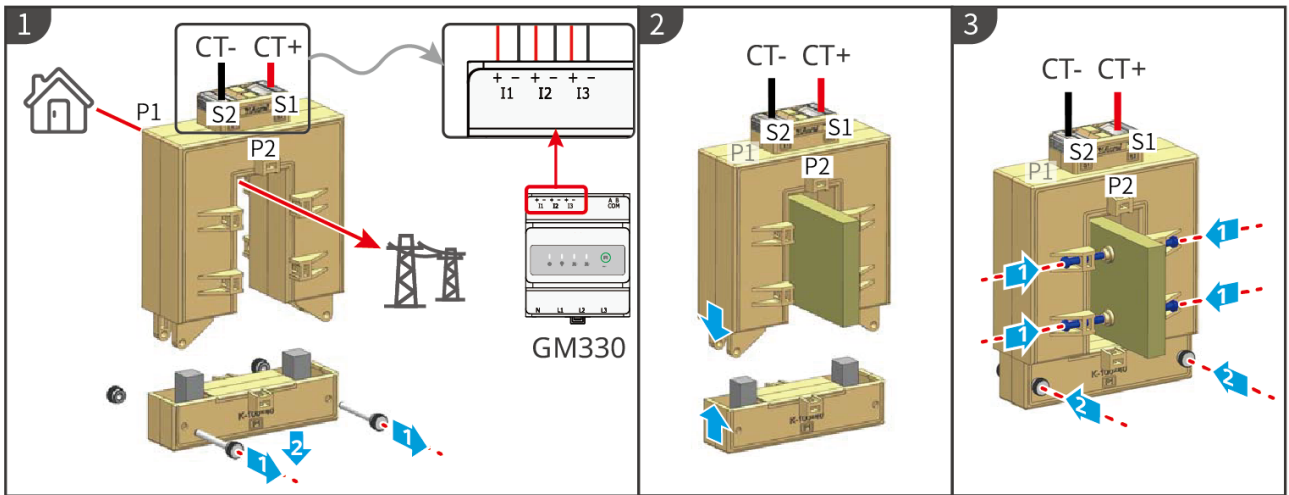

GMK330ELC0003

Installing the CT (Type II)

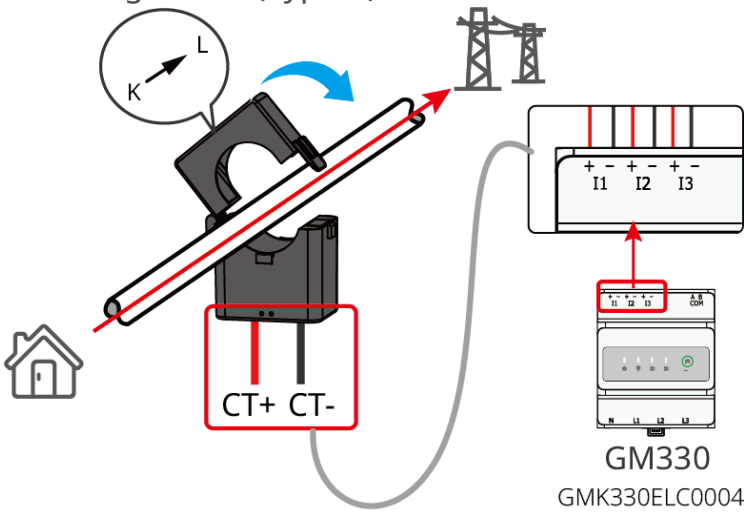

## 6.8 Connecting the Inverter Communication Cable

## NOTICE

- When using the built-in smart meter, please use the delivered CT.
- If you need to use the DRED, RCR or remote shutdown function, turn it on in the SolarGo App after wiring.
- Do not turn on the remote shutdown function in the SolarGo App if the inverter is not connected to a DRED device, otherwise the inverter will be unable to operate on-grid.
- In a parallel system, please connect the DRED, RCR communication cable to the master inverter to achieve the DRED、RCR function.
- To ensure the inverter's waterproof rating, do not remove the waterproof plugs from the unused communication ports on the inverter.
- For the DO signal communication port of the inverter, which connect dry contact signals, the specification are as follows: Max  $\leq$  24Vdc, 1A.
- The communication functions are optional. Connect the cables based on actual needs.
- The inverter supports parameter setting via Bluetooth nearby. It also supports connecting to mobile phones or WEB interfaces through communication modules such as WiFi and LAN to set device-related parameters, view device operation information and error messages, and keep abreast of the system status in a timely manner.
- In the single inverter system, installation of the WiFi/LAN Kit-20 or 4G Kit-CN-G20 smart dongle is supported.
- In a parallel system, both the master and slave inverters must be installed with the WiFi/LAN Kit-20 smart dongle for networking.
- When using the 4G Kit- CN-G20:
  - If parallel operation and networking are required, please contact GoodWe to purchase the WiFi/LAN Kit-20.
  - The built-in SIM card of the 4G smart dongle is a mobile communication card, please confirm whether the device is installed in an area covered by mobile 4G signals. If the installation area is not covered by mobile signal, please contact the operator to optimize the signal.
  - It supports connection to a third-party monitoring platform via the MQTT communication protocol.
- 4G Kit-CN-G20 is an LTE single-antenna device, suitable for application scenarios with low requirements for data transmission rate.

### Communication Function Description

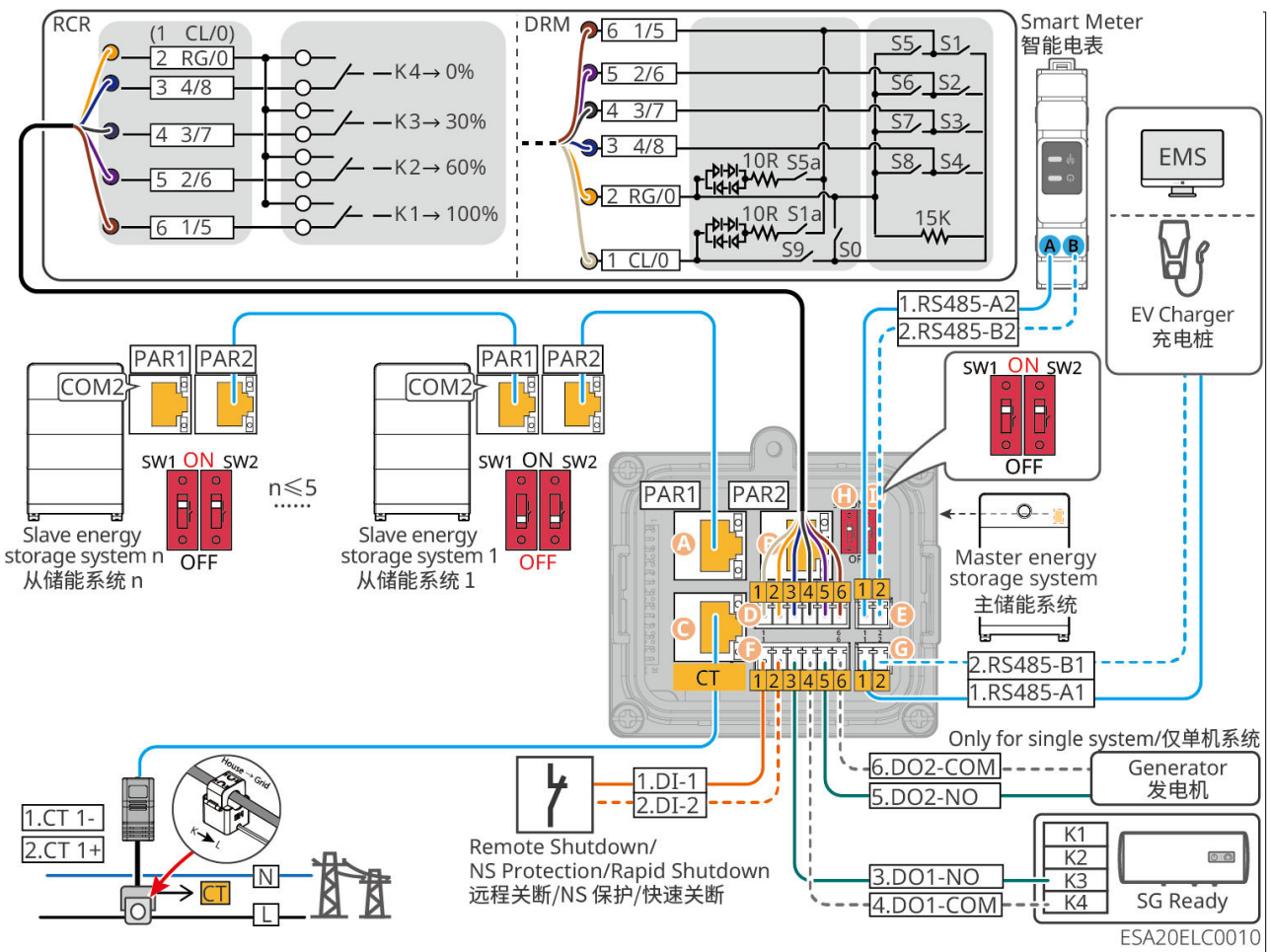

Port (Silk screen printing)		Function	Description
A	PAR1	Parallel Communication Port 1	Parallel communication port. Please use CAT 5E and above standard network cable and RJ45 connector
B	PAR2	Parallel Communication Port 2	
C	CT	CT connection port	CT communication cables only need to be connected when using the inverter's built-in meter.

Port (Silk screen printing)		Function	Description
D	DRM/RCR	RCR, DRE or EnWG 14 functional connection port	<ul style="list-style-type: none"> <li>RCR (Ripple Control Receiver): It provides an RCR signal control port to meet the grid dispatching requirements in Europe.</li> <li>DRED (Demand Response Enabling Device): It provides an DRED signal control port to meet DERD certification requirements in Australia and other regions..</li> </ul>
E	METER	Smart Meter Connection Port	Use RS485 communication to connect external smart meters.
F	DI	Remote shutdown /NS protection/Rapid shutdown	<ul style="list-style-type: none"> <li>External remote shutdown or local NS protection devices are turned off by default.</li> <li>In a rapid shutdown system, the rapid shutdown transmitter and receiver work together to achieve rapid system shutdown. The receiver maintains the modules output by continuously receiving a heartbeat signal from a transmitter. The transmitter can be external or integrated into the inverter. In case of an emergency, you can enable the external initiator to shut down the transmitter, by which the RSD will stop working and the modules be shut down.</li> </ul>
	LOAD	Load Control	<ul style="list-style-type: none"> <li>Support connecting dry contact signals to achieve load control and other functions. DO contact capacity is 12V DC@1A, NO/COM normally open contact.</li> <li>Support SG Ready heat pump connection, control the heat pump through dry contact signal to control the heat pump.</li> </ul>

Port (Silk screen printing)		Function	Description
	GEN	Generator Control Port	A single unit in the network supports accessing the generator control signal to control the generator's start and stop. In microgrid scenarios, connection to a generator is not supported.
G	EMS	EMS/Charging Pile Communication Port	Connecting to a third-party EMS device for energy control or connect to a GoodWe charging pile.
H	SW1	Parallel DIP Switches	In a multi-inverter parallel operation scenario, set the parallel DIP switches of the first and last inverters to the ON position, and set those of the other inverters to the OFF position.
I	SW2		

### Method to connect the communication cable

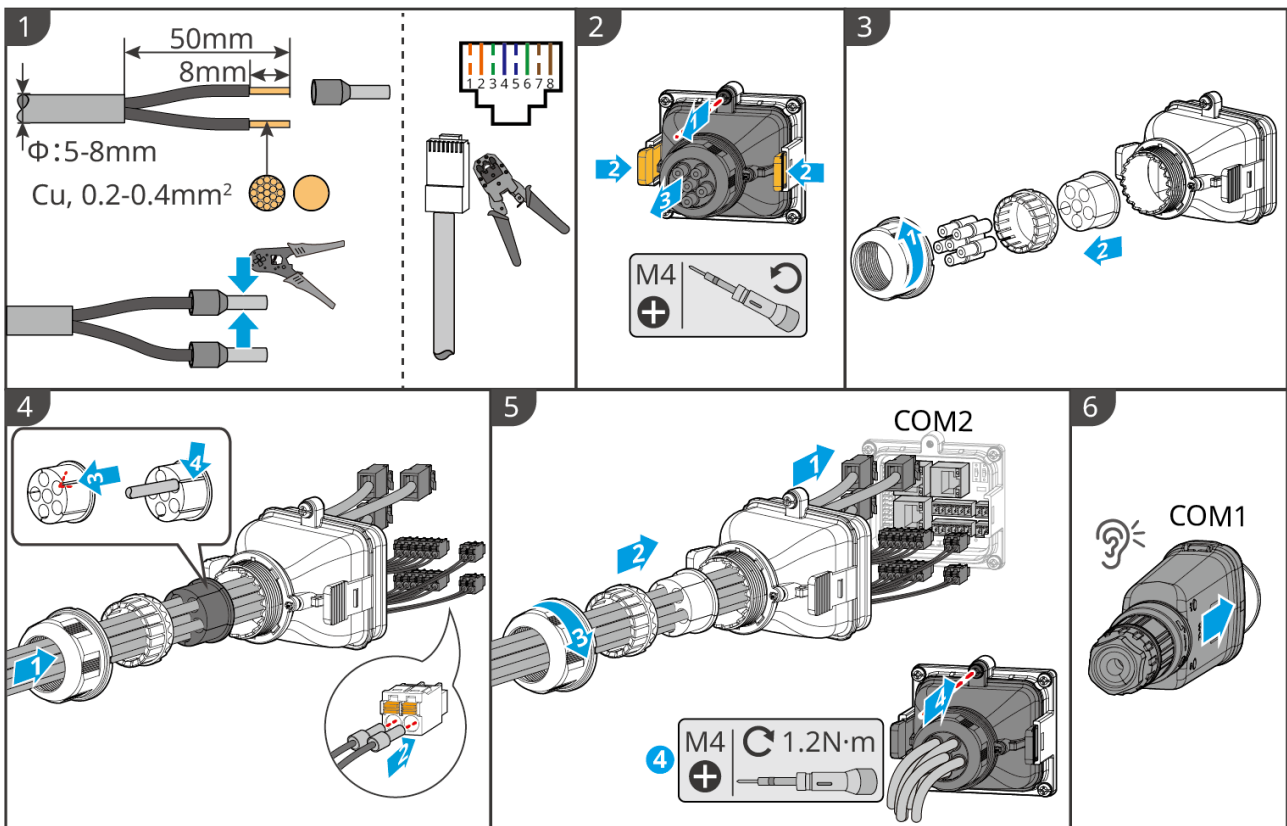

ESA20ELC005

## 7 System Commissioning

### 7.1 Check Before Power ON

No.	Check Item
1	The inverter is firmly installed in a clean place where is well-ventilated and easy to operate.
2	The PE, DC, AC, communication cables are connected correctly and securely.
3	The cable binding shall comply with routing requirements, with reasonable distribution and no damage.
4	Unused wire holes and ports should connect with reliable terminals provided with the accessories and be sealed up.
5	The used cable holes are sealed.
6	The voltage and frequency at the connection point meet the inverter grid connection requirements.

### 7.2 Power ON

 **WARNING**

- **Battery Black Start Function:** When there is no PV power generation in the photovoltaic system and the grid is abnormal, if the inverter cannot operate normally, the battery black start function can be used to force the battery to discharge and start the inverter. The inverter can then enter off-grid mode and operate, with the battery supplying power to the load.
- After the battery system is started, please ensure that the communication between the inverter and the battery system is normal within 15 minutes. If the inverter cannot communicate normally with the battery system, the battery system switch will be automatically disconnected, and the battery system will be powered off.
- When the inverter is operating normally, set the manual transfer switch to position B to supply power to the load via the inverter's BACK-UP port. During inverter shutdown maintenance or in the event of a fault, to ensure uninterrupted load operation, switch the manual transfer switch to position A to supply power to the load from the utility grid.

**Power on**

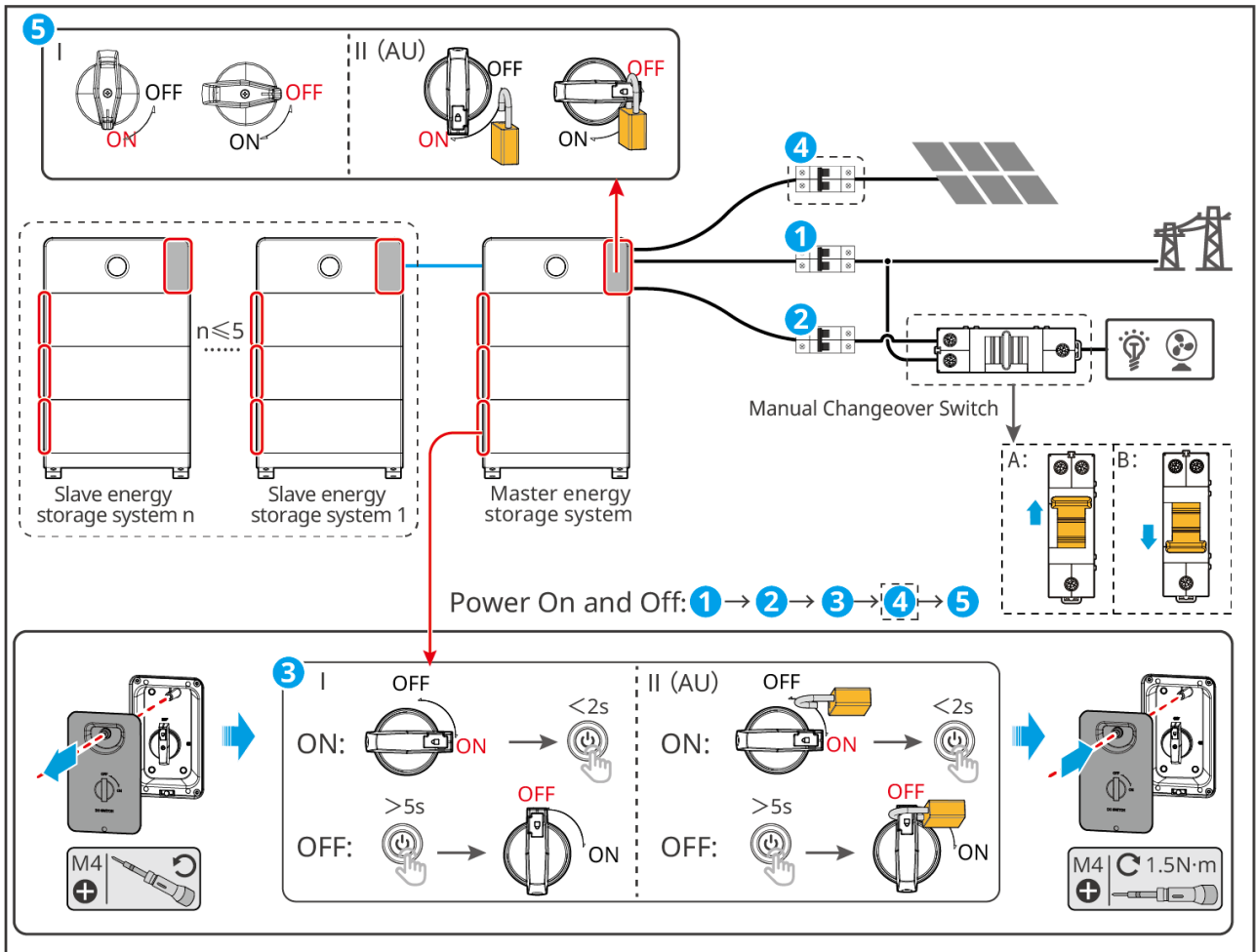

ESA20PWR0002

1. Turn on the ON-GRID circuit breaker.
2. Turn on the BACK-UP circuit breaker, and (optionally) set the manual switch to the B position.
3. Turn the battery power switch to the ON position and briefly press the battery multifunction button.  
When there are multiple batteries in the system, turn all the battery power switch to the ON position. Briefly press the battery multifunction button.
4. (optional) Turn on the circuit breaker between the PV module and the inverter.
5. (optional) Turn on the DC switch of the inverter.

### Battery Black Start:

1. Turn on the ON-GRID circuit breaker.
2. Turn on the BACK-UP circuit breaker.
3. Turn on the battery system switch.

4. Turn on the DC switch of the inverter.
5. Press and hold any battery multi-function button for 2 seconds to start the battery system, and the battery will discharge to activate the inverter.

### 7.3 Installing Protective Cover

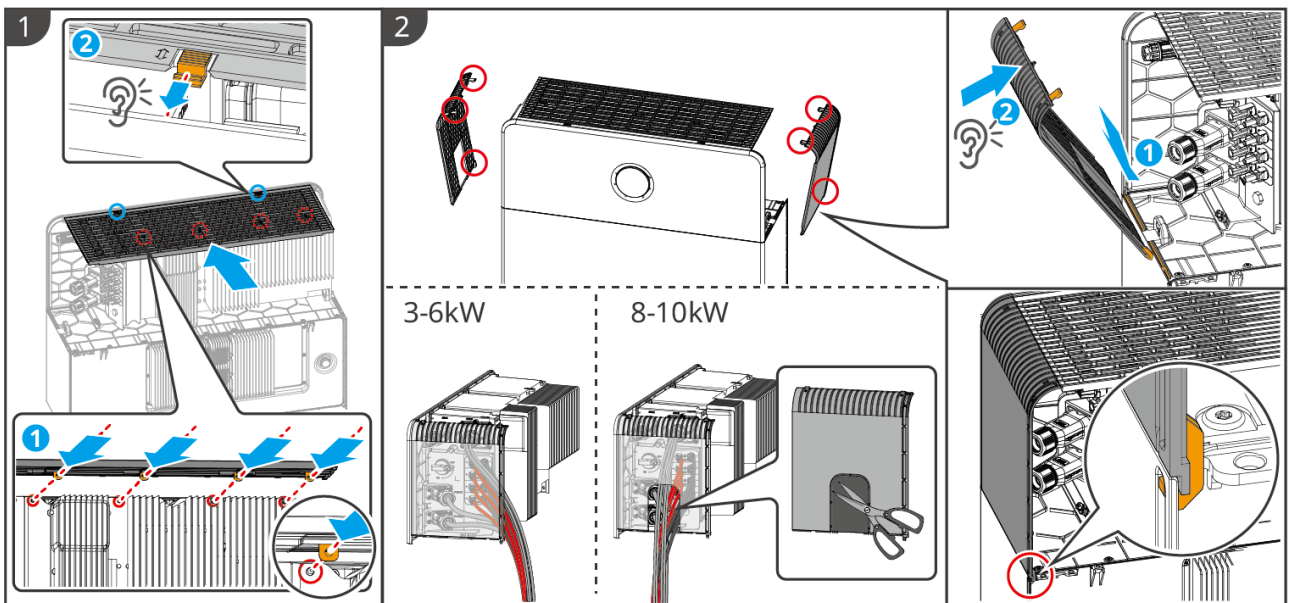

ESA20INT0006

### 7.4 Indicators



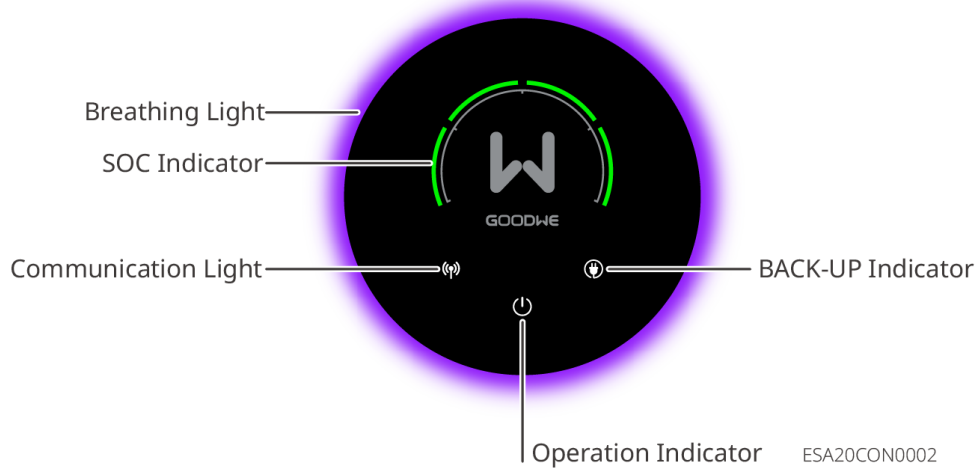





#### 7.4.1 Inverter Indicator















ESA20CON0002

**Breathing light:**

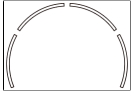
- When the system is in the upgrade state: the breathing light is a green marquee; the marquee is brightest at the beginning and darkest at the end. The length of the marquee light and the upgrade percentage are affected by the SEMS+ APP settings and the device operating status. SEMS+ APP Settings Device Status
- The breathing light status is affected by the settings on the SEMS+ APP except for the inverter upgrade, system failure and inverter power-off status. If you need to set it, please refer to the [11.7.1. "Setting Energy Storage Inverter Parameters" \(Page 244\)](#)

Indicator	Indicator status	Breathing Light Status	Description
		<ul style="list-style-type: none"> <li>• 3min/normal on: blue-purple running light is steady on</li> <li>• normal off: off</li> </ul>	The inverter is power on and in the standby mode.
			The inverter is starting and in self-test mode.
		<ul style="list-style-type: none"> <li>• 3min: Blue-purple breathing turns off after 3 minutes</li> <li>• APP normal on: blue-purple running light is steady on</li> <li>• APP normal off: off</li> </ul>	The inverter is in normal operation under grid-tied or off-grid mode.
		Blinking red	System Failure
		Off	The inverter is powered off.
		/	The monitoring module of the inverter is resetting.
			The inverter fails to connect with the communication termination.

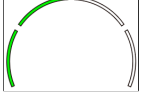
Indicator	Indicator status	Breathing Light Status	Description
			Communication fault between the communication Termination and Server.
			The monitoring of the inverter operates well.
			The monitoring module of the inverter has not been started yet.
			The grid is abnormal, and the power supply to the BACK-UP port of the inverter is normal.
			The grid is normal, and the power supply to the BACK-UP port of the inverter is normal.
			The BACK-UP port has no power supply.
			System Updating
			System Failure
			The battery has no power
			Steady on: Charging Flashing: Discharging Battery SOC: $0\% < \text{SOC} \leq 25\%$

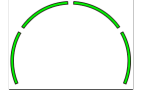
Indicator	Indicator status	Breathing Light Status	Description
			Steady on: Charging Flashing: Discharging Battery SOC: $25\% < SOC \leq 50\%$
			Steady light: Charging Flash: Discharging Battery Battery SOC: $50\% < SOC \leq 75\%$
			Steady on: Charging Flashing: Discharging Battery SOC: $75\% < SOC \leq 100\%$

## 7.4.2 Battery Indicators





### Button Indicator

No.	Green light	 Red light	Battery system	Description
1	On	--	The system is working normally.	Run
2	Blinks 1 time/S.	--	The system is ready.	Standby
	Blinks 3 time/S.	--	The PC communication is lost.	--
3	Blinks 1 time/ 2S.	--	System Alarm	When there is an under-voltage fault of level 2, 3, or 4, the indicator flashes. For other level 2 faults, the indicator flashes.

No.	Green light	 Red light	Battery system	Description
4	--	On	System Failure	Fault list showing faults of level 3 or higher (undervoltage faults remain ON when at level 5)

### 7.4.3 Smart Meter Indicator

GM330

Type	Status	Description
Power light 	On	Power on, no RS485 communication.
	Blinks.	Power on, RS485 communication works properly.
	Off	The smart meter has been powered off.
Communication indicator 	Off	Reserved
	Blinks.	Press the Reset button for more than 5 seconds, power light, buying or selling electricity indicator light flash: Reset the meter.
Importing or exporting indicator 	On	Importing from the grid.
	Blinks.	Exporting to the grid.
	Off	Do not import from and export to the grid.
	Reserved	

GMK110







Type	Status	Description
Power light 	On	The smart meter is power on.
	Off	The smart meter has been powered off.
	Blinks.	Meter communication is normal.

Type	Status	Description
Communication indicator 	Off	Meter communication is abnormal or has no communication.

#### 7.4.4 Smart Dongle Indicator

- WiFi/LAN Kit-20

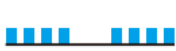
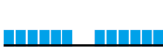





Note
<ul style="list-style-type: none"> <li>• After double press the Reload button to turn on Bluetooth, the communication indicator light will switch to single flash. Please connect to the SolarGo App within 5 minutes or Bluetooth will turn off automatically.</li> <li>• The single flash status of the communication indicator only appears after double-press the Reload button to turn on Bluetooth.</li> </ul>



Indicator	Status	Description
Power		Power On: The smart dongle is powered on.
		Power Off: The smart dongle is powered off.
Communication indicator		Power On: The WiFi or LAN communication is working well.
		Blinks 1 time: The Bluetooth signal is on and waiting for connection to the SolarGo app.
		Blinks 2 times: The Smart Dongle is not connected to the router.
		Blinks 4 times: The Smart Dongle is communicating with the router but not connected to the server.
		Blinks 6 times: The Smart Dongle is identifying the connected device.
		Power Off: The software of the Smart Dongle is in reset or not powered on.

Indicator	Color	Status	Description
Communication indicator in LAN Port	Green	On	The 100Mbps wired network is normally connected.
		Off	<ul style="list-style-type: none"> <li>The Internet cable is not connected.</li> <li>The 100Mbps wired network is abnormally connected.</li> <li>The 10Mbps wired network is normally connected.</li> </ul>
	Yellow	On	The 10/100Mbps wired network is normally connected, but no communication data is received or transmitted.
		Blinks	The communication data is being transmitted or received.
		Off	The Internet cable is not connected.

Button	Description
Reload	Press and hold for 0.5 to 3 seconds to reset the Smart Dongle.
	Press and hold for 6 to 20 seconds to restore the Smart Dongle to factory settings.
	Double press quickly to activate Bluetooth signal (only lasts for 5 minutes).

• 4G Kit-CN-G20

Indicator	Status	Description
		Power On: The Smart Dongle is powered on.
		Off The Smart Dongle is powered off.
		Power On: The Smart Dongle is connected to the server and the communication is normal.
		Blinks 2 times: The Smart Dongle is not connected to the foundation.

Indicator	Status	Description
		Blinks 4 times: The Smart Dongle is connected to the foundation but disconnected to the server.
		Blinks 6 times: The Smart Dongle is not connected to the inverter.
		Power Off: The software of the Smart Dongle is in reset or not powered on.

Button	Description
RELOAD	Press and hold for 0.5 to 3 seconds to reset the Smart Dongle.
	Press and hold for 6 to 20 seconds to restore the Smart Dongle to factory settings.

## 8 Rapid System Configuration

### 8.1 Downloading the App

#### 8.1.1 Downloading SolarGo App

Make sure that the mobile phone meets the following requirements:

- Mobile phone operating system: Android 5.0 or later, iOS 13.0 or later.
- The mobile phone can access the Internet.
- The mobile phone supports WLAN or Bluetooth.

#### NOTICE

Once the SolarGo App has been installed, you will receive automatic notifications when updates are available.

Method 1: Search SolarGo in Google Play (Android) or App Store (iOS) to download and install the app.



Method 2: Scan the QR code below to download and install the App.

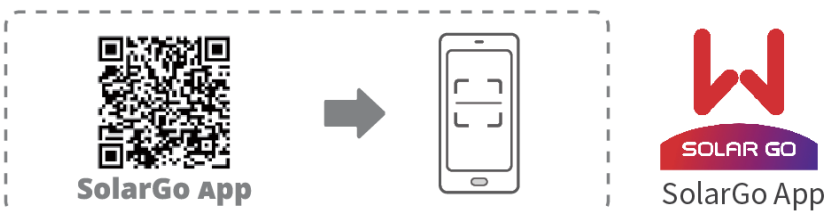

#### 8.1.2 Downloading SEMS+ APP

Make sure that the mobile phone meets the following requirements:

- Mobile phone operating system: Android 6.0 or later, iOS 13.0 or later.
- The mobile phone can access the Internet.
- The mobile phone supports WLAN or Bluetooth.

## Download Method:

### Method 1:

Search SEMS+ in Google Play (Android) or App Store (iOS) to download and install the App.

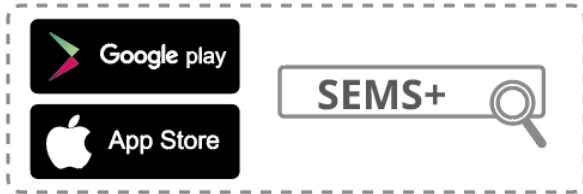

### Method 2:

Scan the QR code below to download and install the App.



## 8.2 Connecting the Hybrid Inverter (Bluetooth)

**Step 1** Ensure that the inverter is power on, both the inverter and the communication module are working properly.

**Step 2** Select **Bluetooth** tab on the SolarGo app homepage.

**Step 3** Pull down or tap **Search Device** to refresh the device list. Find the device by the the inverter serial number. Tap the device name to log into the **Home** page. Select the device by checking the serial number of the master inverter when multi inverters are parallel connected.

**Step 4** For first connection with the equipment via Bluetooth, there will be a Bluetooth pairing prompt, tap **Pair** to continue the connection.

**Step 5** Log in as an Owner or an Installer. Initial password: 1234. Default password: 1234.

**Step 6** (Optional): If connecting via WLA-\*\*\* or WFA-\*\*\*, enable Bluetooth Stays On following the prompts as entering the device details page. Otherwise, the bluetooth signal of the device will be off after disconnection.

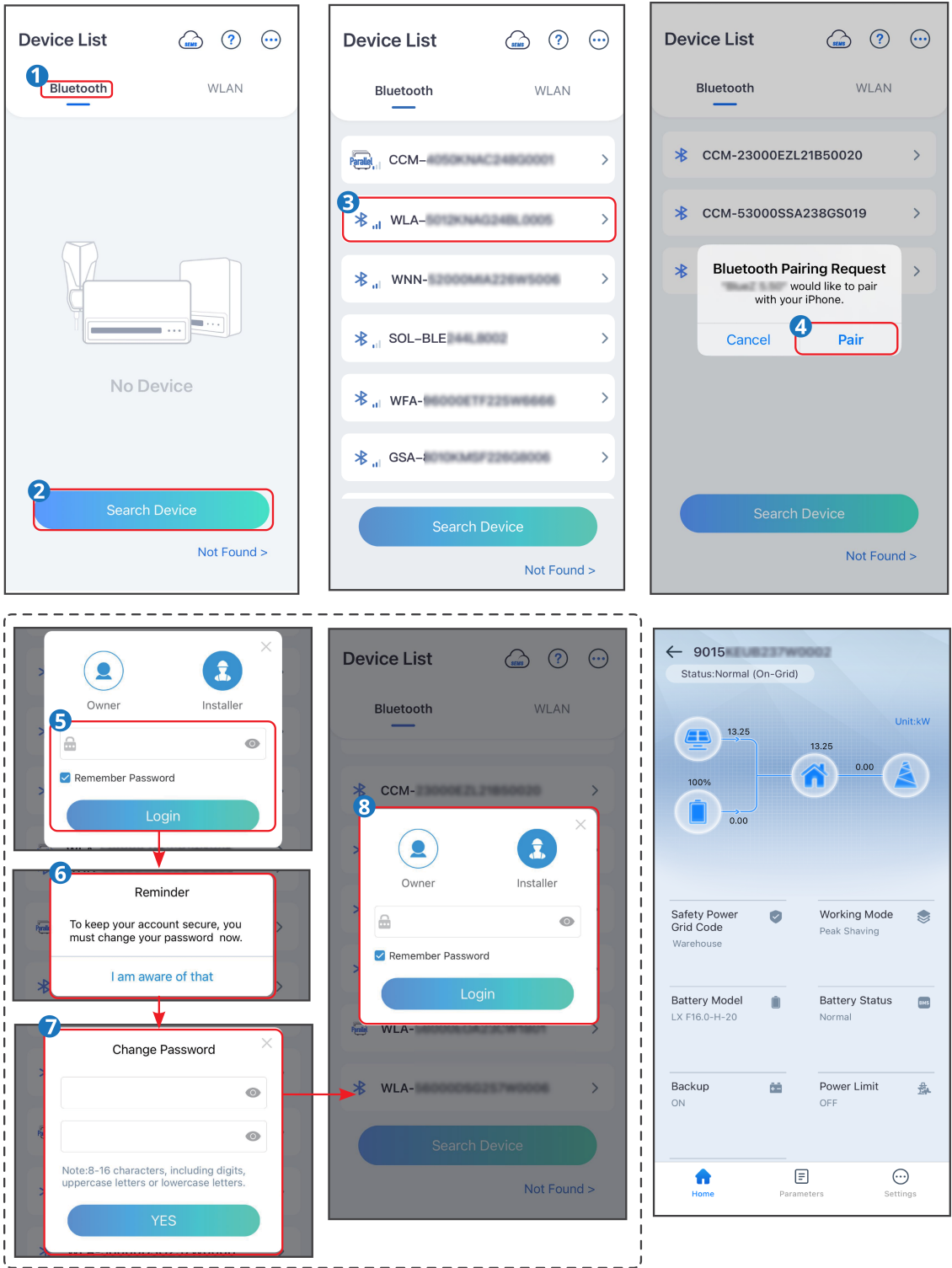

### 8.3 Connect the Smart Dongle

When connecting to an inverter via the SolarGo App, if the inverter signal cannot be detected, the device list interface will display the signal of the smart dongle connected to the inverter.

## Supported Smart Dongle types:

- WiFi/LAN Kit-20
- Ezlink3000
- 4G Kit-CN-G20 ; 4G Kit-CN-G21 ; 4G Kit-G20

Step 1: On the homepage of the SolarGo App, find the grayed-out SN number of the smart dongle and click to enter the settings interface.

Step 2: Set or query parameter information according to actual needs.

- Communication Configuration: Click to set WLAN/LAN parameters and connect the module to the router.
- Communication Module Logs: Click to enter the module log download interface.
- Device Information: Click to view the firmware version of the smart dongle. If a version update is available, you can refer to the on-screen prompts to complete the update.

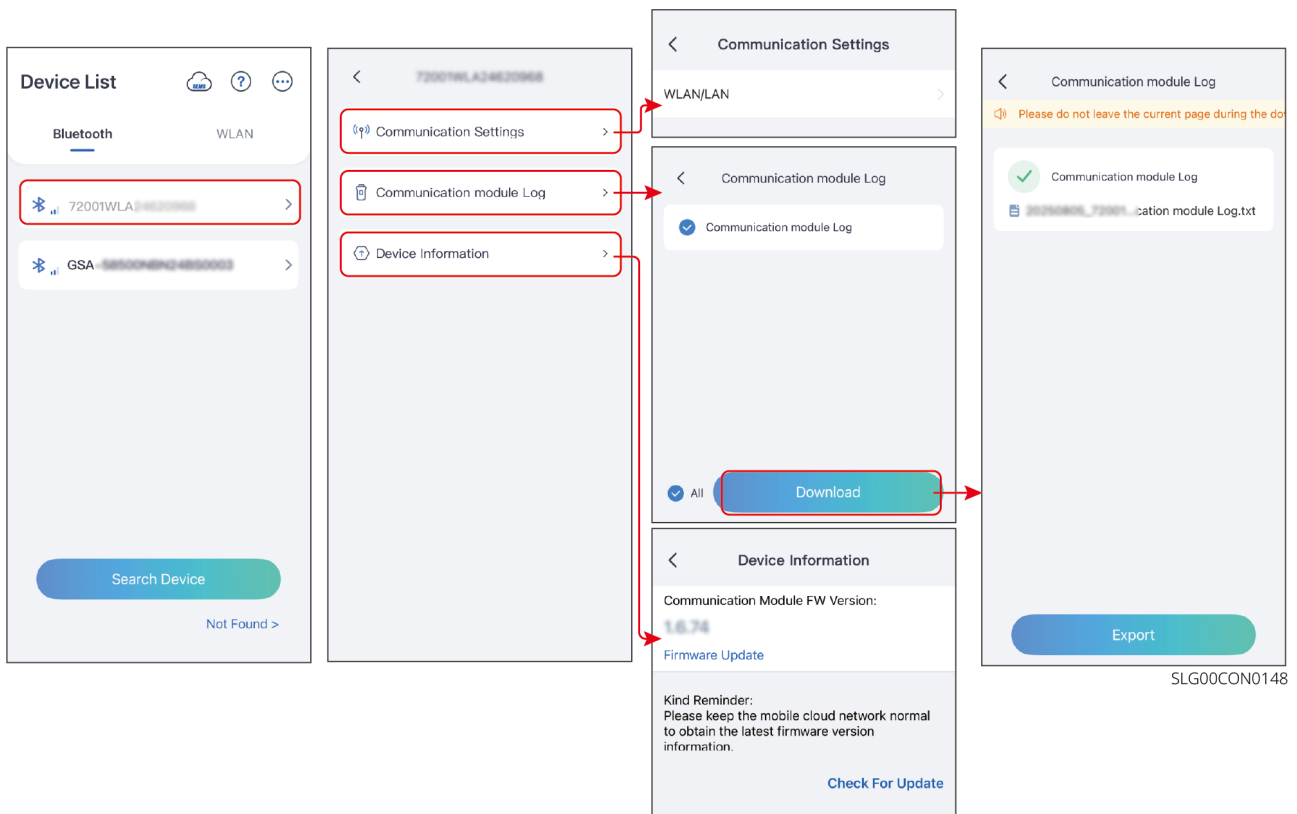

## 8.4 Setting Communication Parameters

## NOTICE

The communication configuration interface may be different if the inverter uses different communication modes or connects different communication modules. Please refer to the actual interface.

### 8.4.1 Setting Privacy and Security Parameters

#### Type I

**Step 1** : Tap **Home** > **Settings** > **Communication Setting** > **Privacy & Security** to set the parameters.

**Step 2** : Set the new password for the WiFi hotspot of the communication module, and tap **Save**.

**Step 3** Open the WiFi settings of your phone and connect to the inverter's WiFi signal (Solar WiFi\*\*) with the new password.

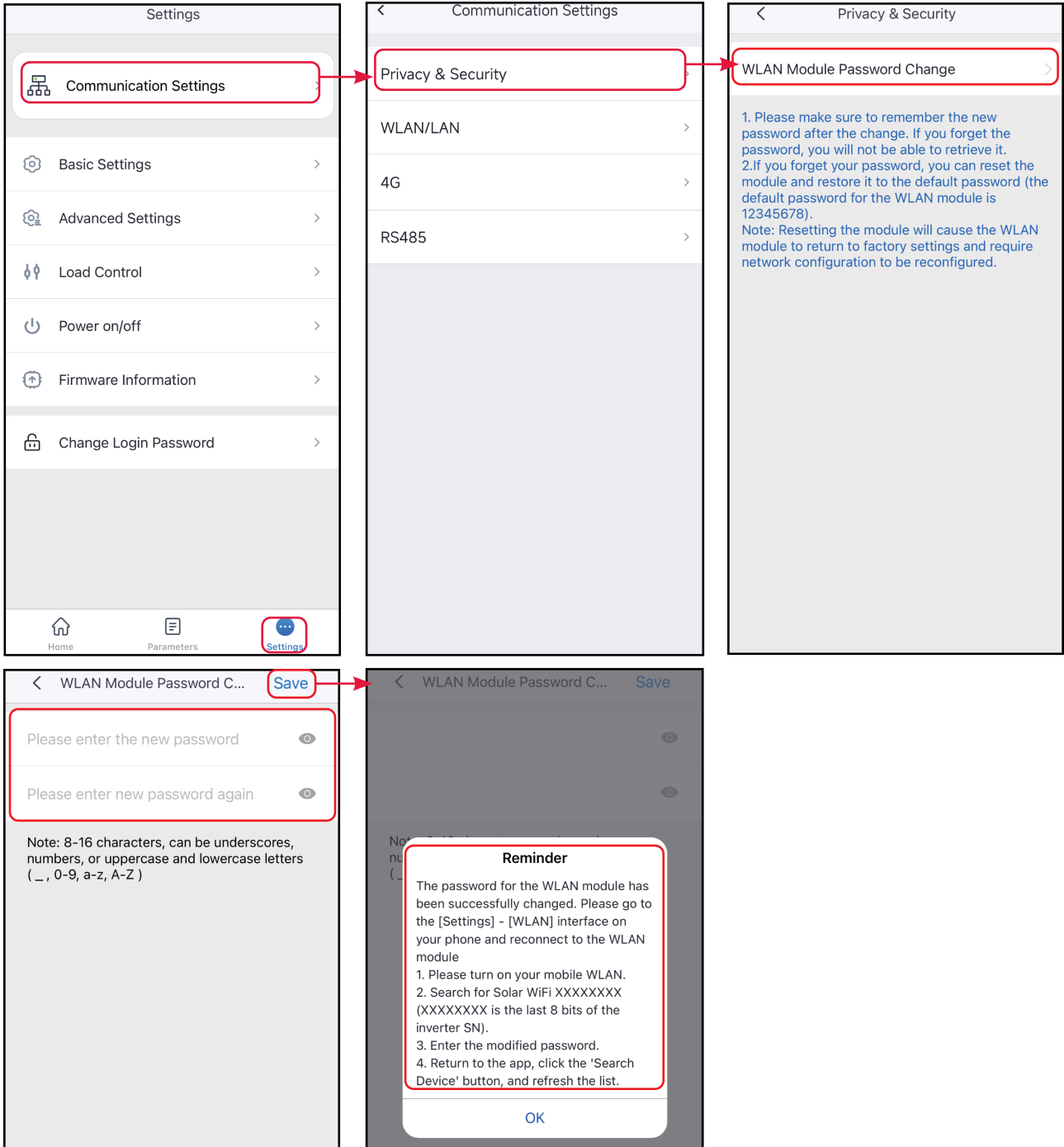

## Type II

**Step 1 :** Tap **Home > Settings > Communication Setting > Privacy & Security** to set the parameters.

**Step 2** Enable Bluetooth Stays On or WLAN Control based on actual needs.

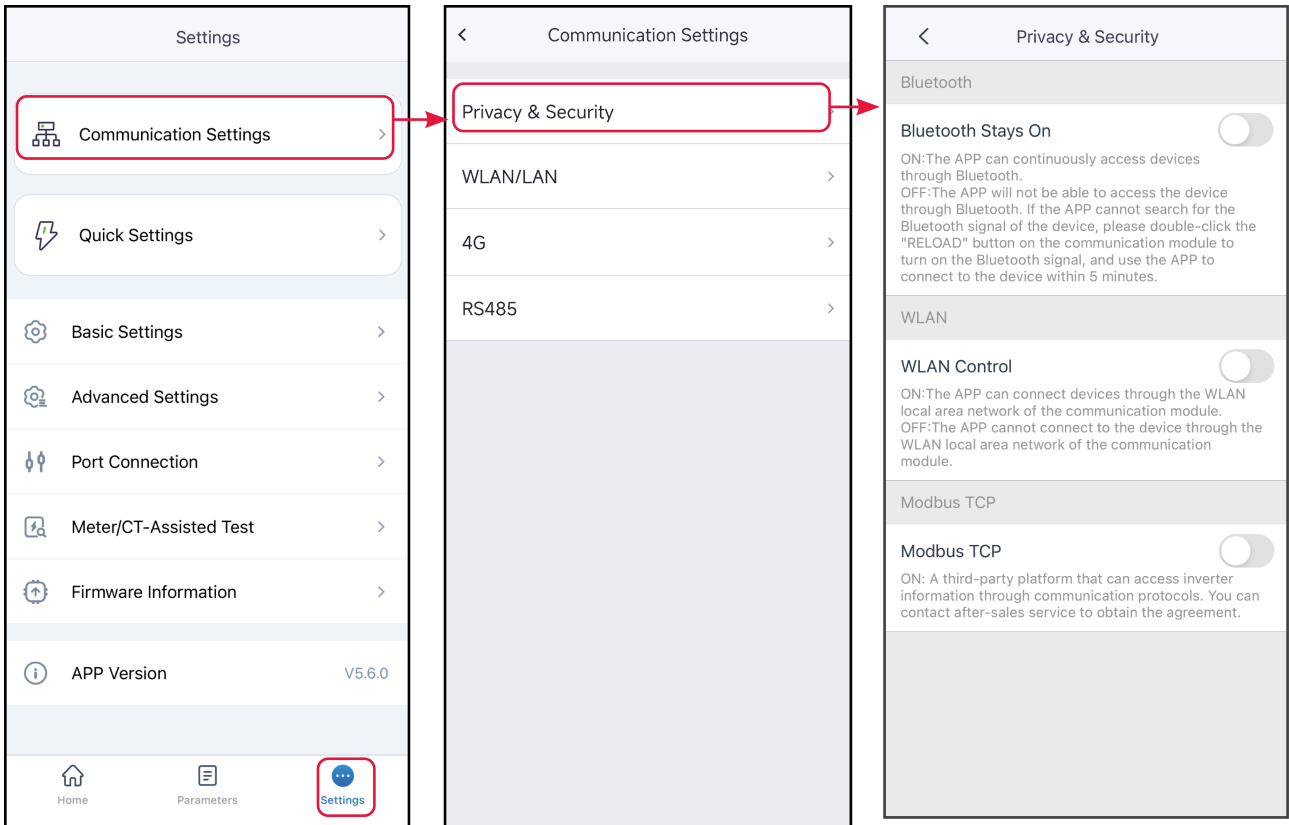

No.	Parameters	Description
1	Bluetooth Stays On	Disabled by default. Enable the function, the bluetooth of the device will be contentious on to keep connected to SolarGo. Otherwise, the bluetooth will be off in 5 minutes, and the device will be disconnected from SolarGo.
2	WLAN Control	Disabled by default. Enable the function, the device and the SolarGo can be connected through the WLAN when they are on the same LAN. Otherwise, they cannot be connected even if they are on the same LAN.
3	Modbus-TCP	Enable the function, the third party monitoring platform can access inverter through Modbus-TCP communication protocol.
4	SSH control Ezlink	After enabling this function, third-party platforms can connect to and control EzLink's Linux system.

### Type III

**Step 1 :** Tap **Home > Settings > Communication Setting > Privacy & Security** to set

the parameters.

**Step 2 : Enable Bluetooth Stays On or Login Password based on actual needs.**

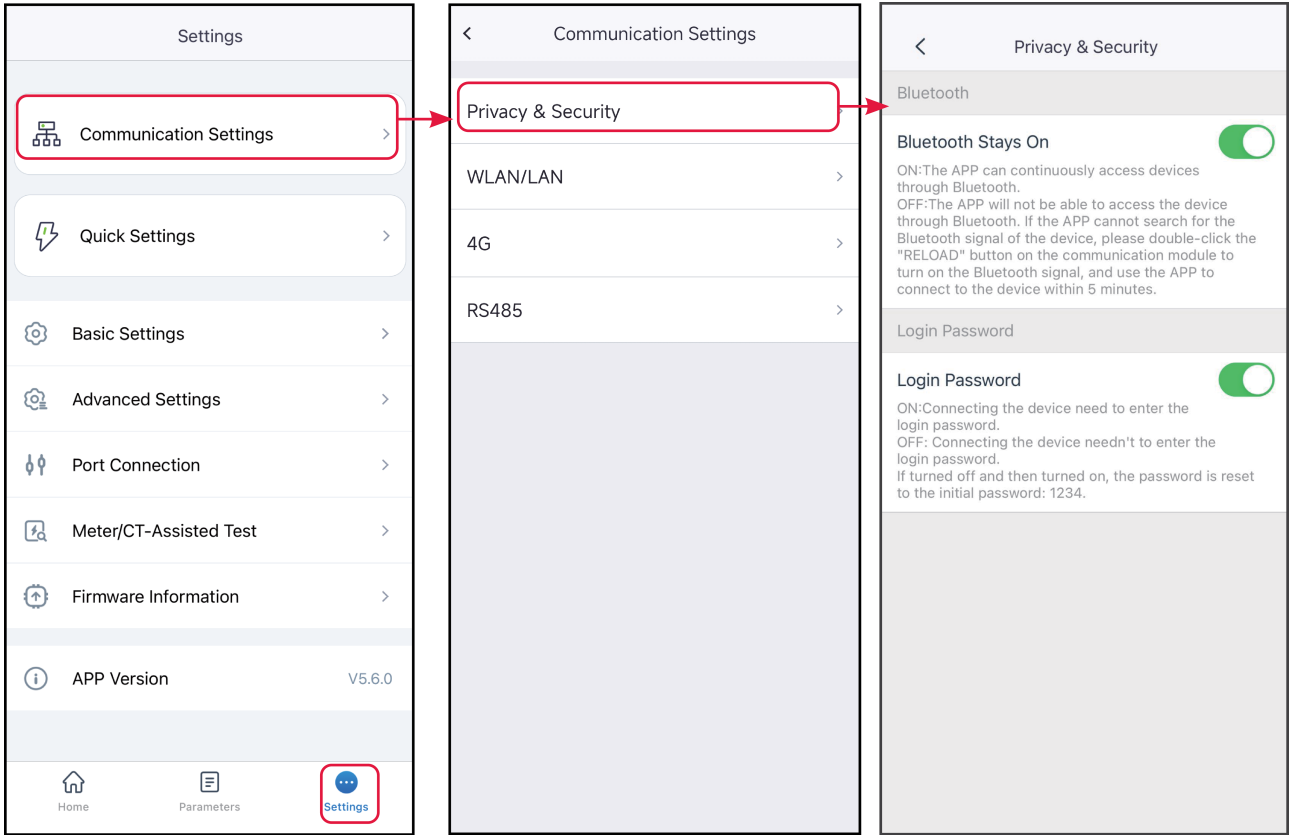

No.	Parameters	Description
1	Bluetooth Stays On	Disabled by default. Enable the function, the bluetooth of the device will be contentious on to keep connected to SolarGo. Otherwise, the bluetooth will be off in 5 minutes, and the device will be disconnected from SolarGo.
2	Password	Disabled by default. Enable the function, you will be prompted to enter the login password when connecting the device to SolarGo. Use the initial password and change it at the first login prompt.

**8.4.2 Setting WLAN/LAN Parameters**

## NOTICE

When the inverter is connected to different communication modules, the communication configuration interface may be different. Please refer to the actual interface.

**Step 1 :** Tap **Home > Settings > Communication Setting > WLAN/LAN** to set the parameters.

**Step 2 :** Configure the WLAN or LAN parameters based on actual needs.

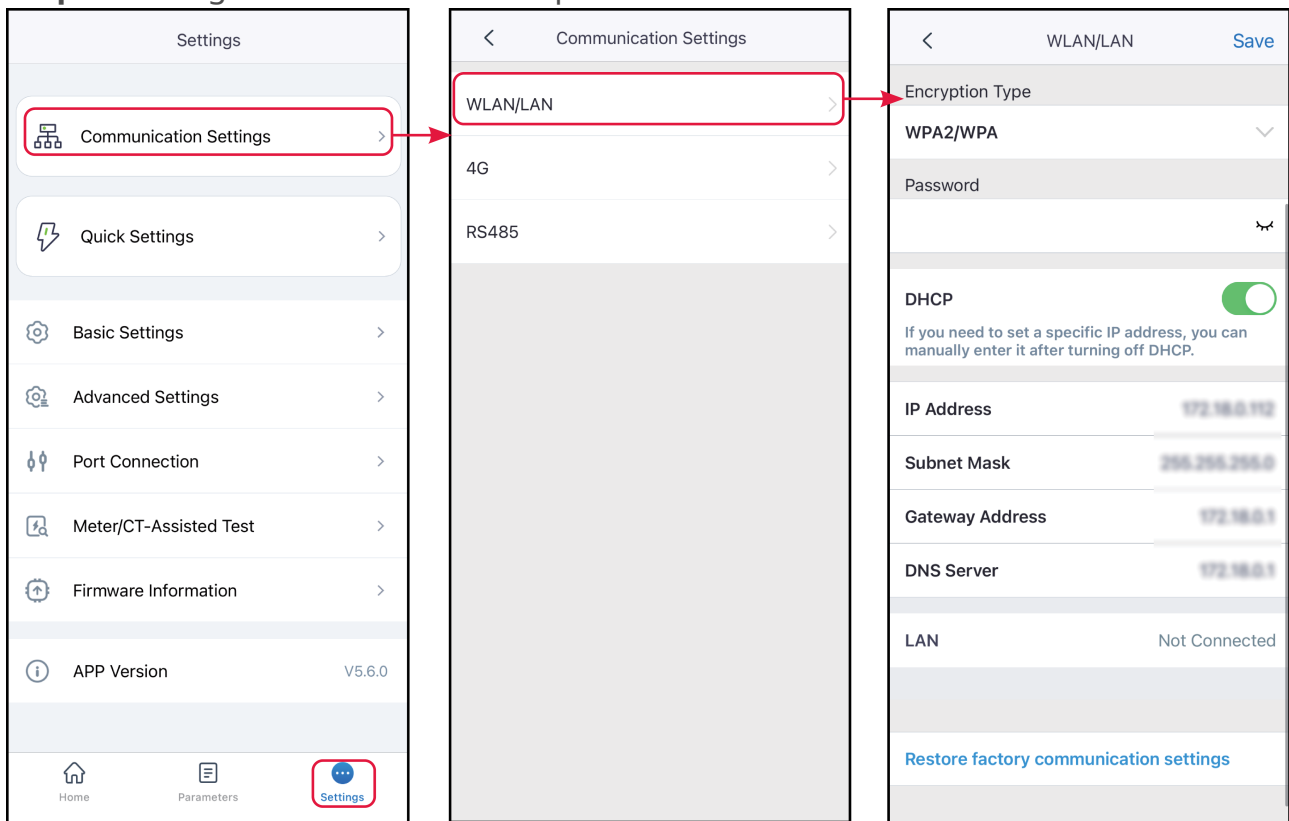

No.	Parameters	Description
1	Network Name	Only for WLAN. Select WiFi based on the actual connecting.
2	Password	Only for WLAN. WiFi password for the actual connected network.
3	DHCP	Enable DHCP when the router is in dynamic IP mode. Disable DHCP when a switch is used or the router is in static IP mode.

No.	Parameters	Description
4	IP Address	Do not configure the parameters when DHCP is enabled. Configure the parameters according to the router or switch information when DHCP is disabled.
5	Subnet Mask	
6	Gateway Address	
7	DNS Server	

### 8.4.3 Configuring RS485 Parameters

#### NOTICE

Set the communication address of the inverter. For a single inverter, the address is set based on actual needs. For multi connected inverters, the address of each inverter should be different while cannot be 247.

**Step 1:** Tap **Home > Settings > Communication Settings > RS485** to set the parameters.

**Step 2 :** Set the Modbus Address And Baud Rate base on actual situation.

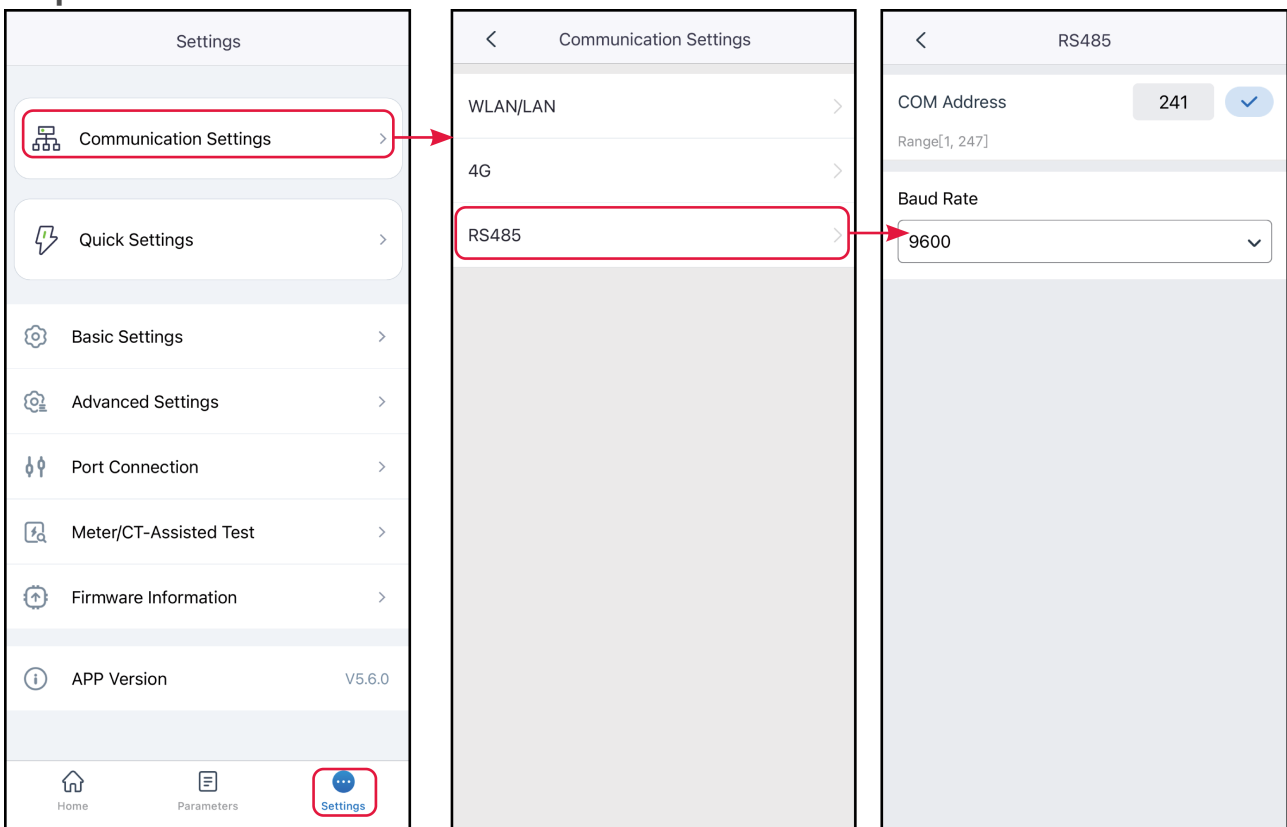

# 8.5 Quick Setting the Basic Information

## NOTICE

- The setting page varies depending on inverter model.
- The parameters will be configured automatically after selecting the safety country/region, including overvoltage protection, undervoltage protection, overfrequency protection, underfrequency protection, voltage/frequency connection protection,  $\cos\phi$  curve, Q(U) curve, P(U) curve, FP curve, HVRT, LVRT, etc. Tap Home > Settings > Advanced Settings > Safety Parameters to check the parameters after selecting the safety country.
- The power generation efficiency is different in different working modes. Set the working mode according to the local requirements and situation.
  - Self-use mode: The basic working mode of the system. PV power generation is used to supply power to the load first, the excess power is used to charge the battery, and the remaining power is sold to the grid. When PV power generation cannot meet the load's power demand, the battery will supply power to the load; when the battery power also cannot meet the load's power demand, the grid will supply power to the load.
  - Back-up mode: The back-up mode is mainly applied to the scenario where the grid is unstable. When the grid is disconnected, the inverter turns to off-grid mode and the battery will supply power to the load; when the grid is restored, the inverter switches to grid-tied mode.
  - Economic mode: It is recommended to use economic mode in scenarios when the peak-valley electricity price varies a lot. Select Economic mode only when it meets the local laws and regulations. Set the battery to charge mode during Vally period to charge battery with grid power. And set the battery to discharge mode during Peak period to power the load with the battery.
  - Off-grid mode: suitable for areas without power grid. PV and batteries form a pure off-grid system. PV generates electricity to power the load and excess electricity charges the battery. When PV power generation cannot meet the power demand of the load, the battery will supply power to the load.
  - Smart charging: In some countries/regions, the PV power feed into the utility grid is limited. Select Smart Charging to charge the battery using the surplus power to minimize PV power waste.
  - Peak shaving mode: Peak shaving mode is mainly applicable to peak power limited scenarios. When the total power consumption of the load exceeds the power consumption quota in a short period of time, battery discharge can be used to reduce the power exceeding the quota.

## 8.5.1 Quick Setting the Basic Information(Type I)

**Step 1:** Tap **Home > Settings > Quick Settings** to set the parameters.

**Step 2 :** Enter the password for quick settings. Contact the supplier or after sales service for password. Password for professional technicians only.

**Step 3 :** Some models support one-click configuration. Select **Guided Mode** to quickly configure the system.

**Step 4:** Select Grid Code(Safety Code)accordingly. Tap **Next** to set the Working Mode.

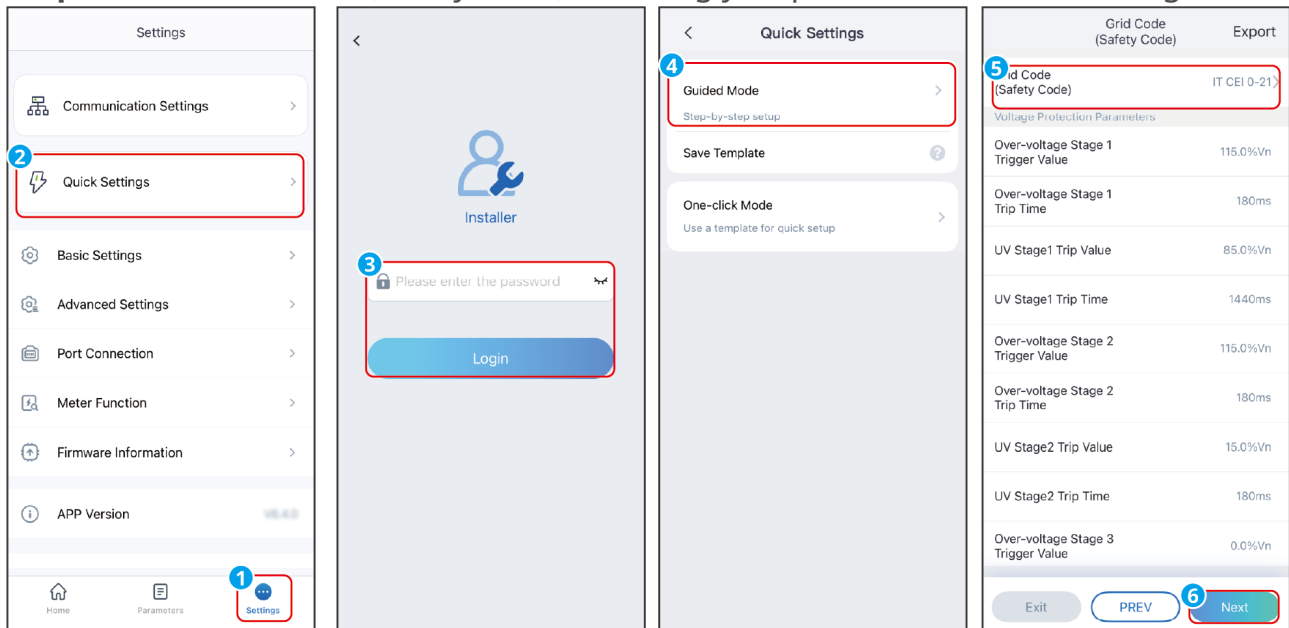

SLG00CON0121

**Step 5:** Set the working mode based on actual needs. Tap **Next** to set the Working Mode. For some models, after the working mode configuration is completed, it will automatically enter the CT/meter self-test state. At this time, the inverter will temporarily disconnect from the grid and then automatically reconnect.

**Step 6 :** Select the battery based on actual situation whether it is **First Installation, Routine Operation** or **Replacement Installation**.

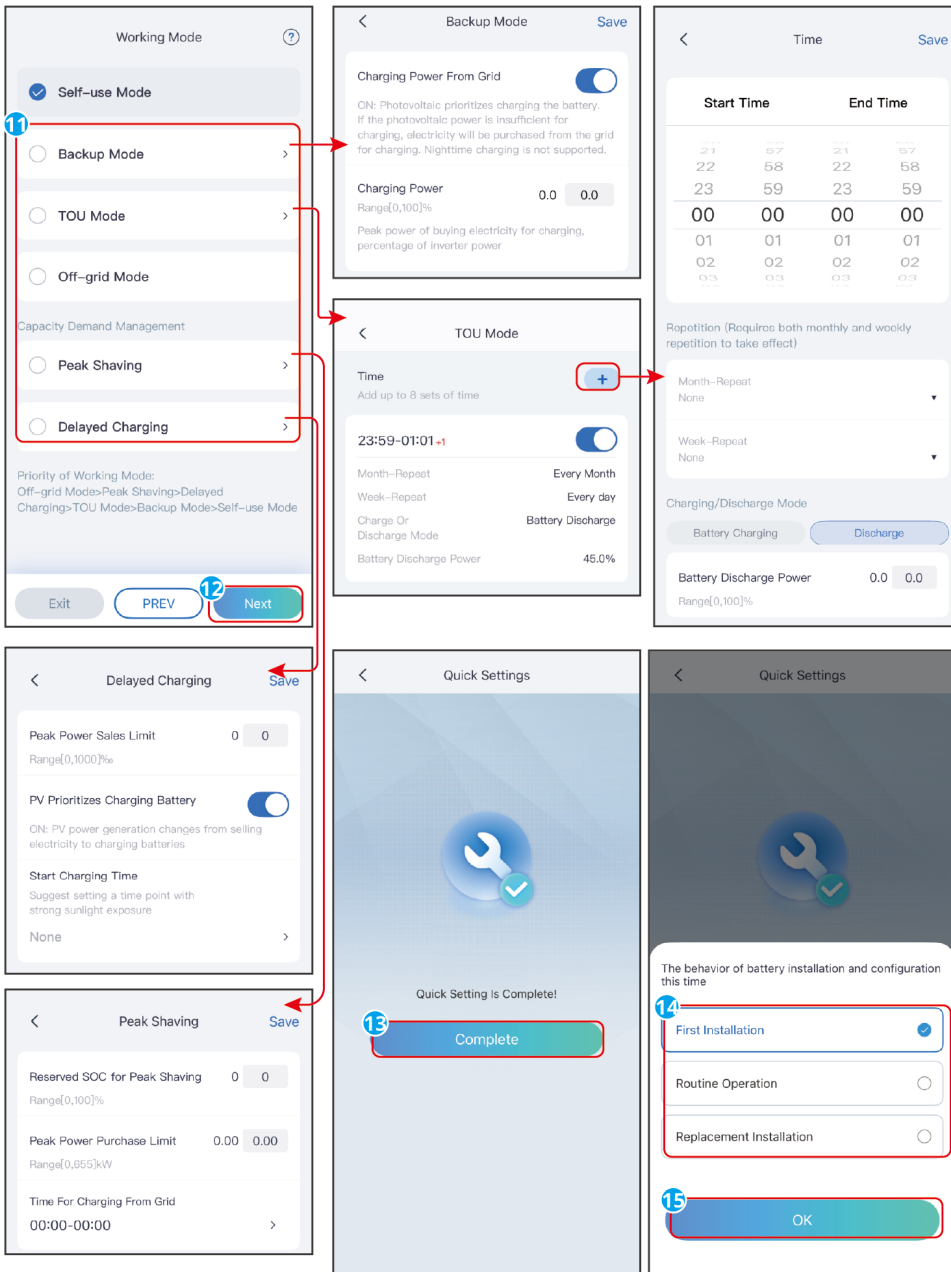

SLG00CON0060

No.	Parameters	Description
Back-up mode		
1	Charging Power From Grid	Enable Charging Power From Grid to allow power purchasing from the utility grid.
2	Charging Power	The percentage of the purchasing power to the rated power of the inverter.
TOU mode		

No.	Parameters	Description
3	Start Time	Within the Start Time and End Time, the battery is charged or discharged according to the set Battery Mode as well as the Rated Power.
4	End Time	
5	Charge Discharge Mode	Charge or discharge according to actual needs.
6	Rated Power	The percentage of the charging/discharging power to the rated power of the inverter.
7	Charge Cut-off SOC	The battery stop charging/discharging once the battery SOC reaches Charge Cut-off SOC.
Peakshaving		
8	Reserved SOC For Peakshaving	In Peak Shaving mode, the battery SOC should be lower than Reserved SOC For Peakshaving. Once the battery SOC is higher than Reserved SOC For Peakshaving, the peak shaving mode fails.
9	Peak Power Purchase Limit	Set the maximum power limit allowed to purchase from the grid. When the loads consume power exceed the sum of the power generated in the PV system and Peak Power Purchase Limit, the excess power will be made up by the battery.
10	Time for Charging From Grid	The utility grid will charge the battery between Start Time and End Time if the load power consumption do not exceed the power quota. Otherwise, only PV power can be used to charge the battery. Otherwise, only PV power can be used to charge the battery.
Smart charging		
11	Peak Power Sales Limit	Set the Peak Power Sales Limit in compliance with local laws and regulations. The Peak Limiting Power shall be lower then the output power limit specified by local requirements.
12	PV Prioritizes Charing Battery	During charging time, the PV power will first charge the battery.

No.	Parameters	Description
13	Start Charging Time	

**Step 7 :** For devices that support one-click configuration, a template can be generated based on the completed configuration.

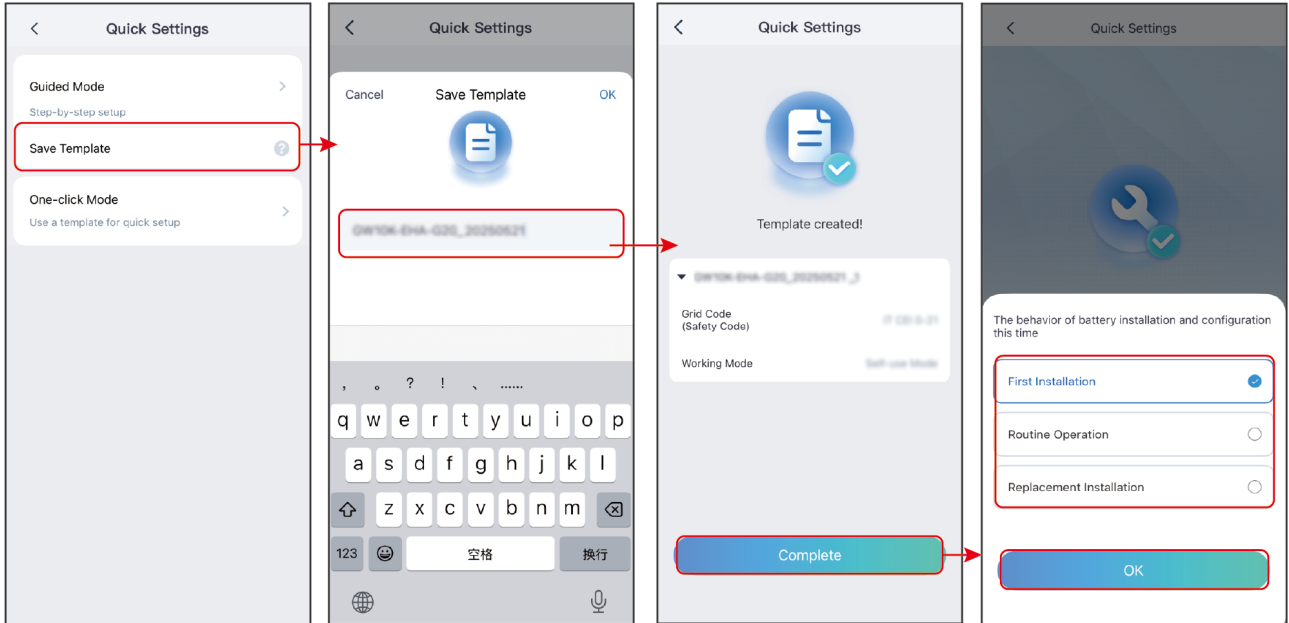

SLG00CON0119

**Step 8:** If you already have a one-click configuration template, you can use the existing template direct import mode to quickly complete the configuration.

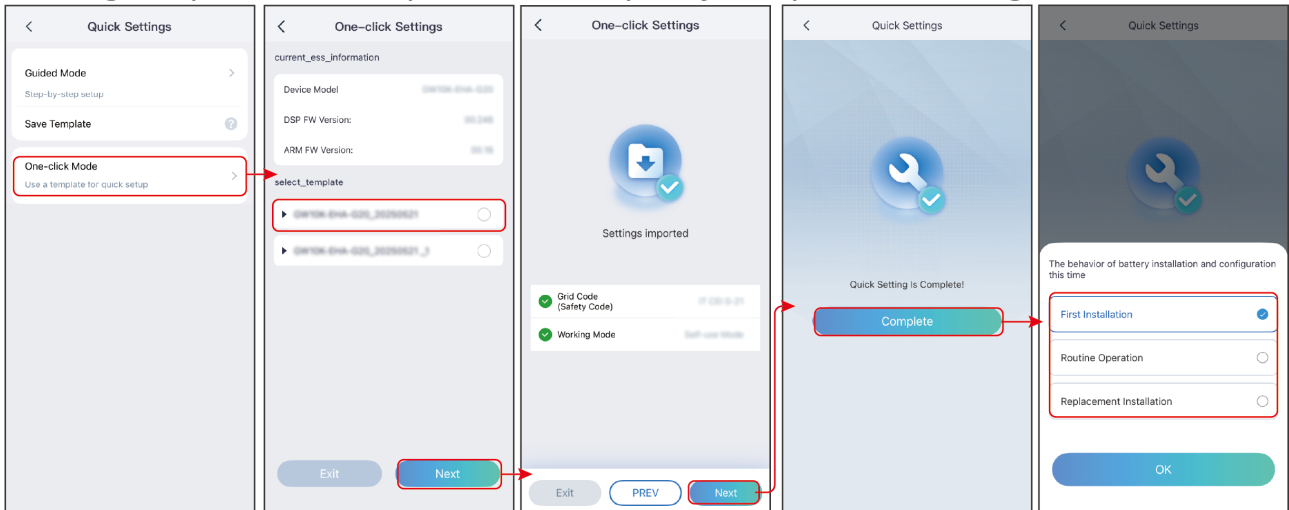

SLG00CON0120

## 8.6 Creating a Station

**Step 1:** Tap  on overview or station page, or tap **Create Station** on service page.

**Step 2:** Enter station information on the **Creat Station** page.

**Step 3:** Tap **Save&Exit** to complete creating a station, without devices added. Or tap **Save&Continue** to add devices. Support adding multiple devices.

SEMS0011

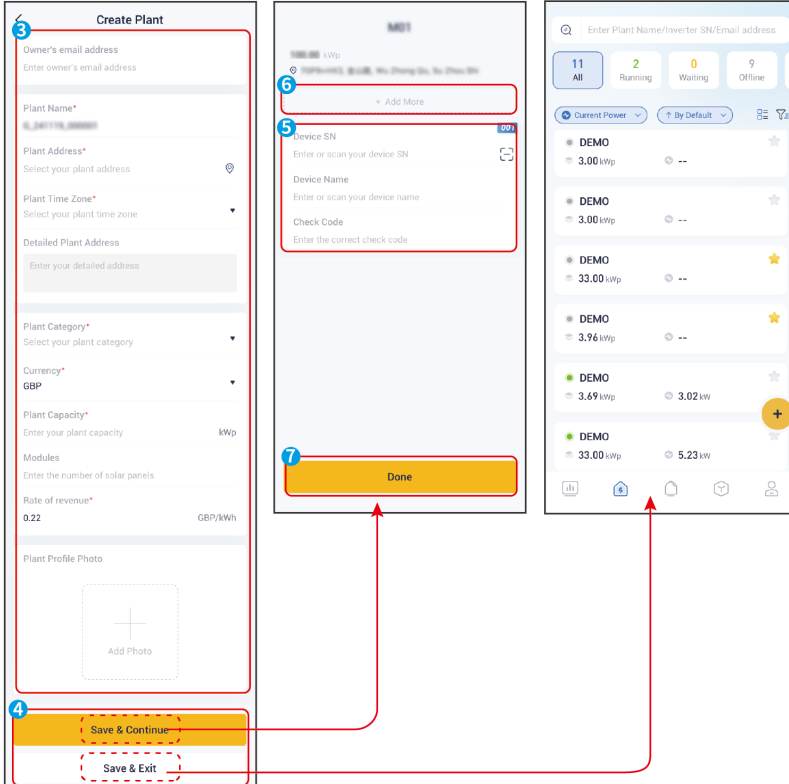
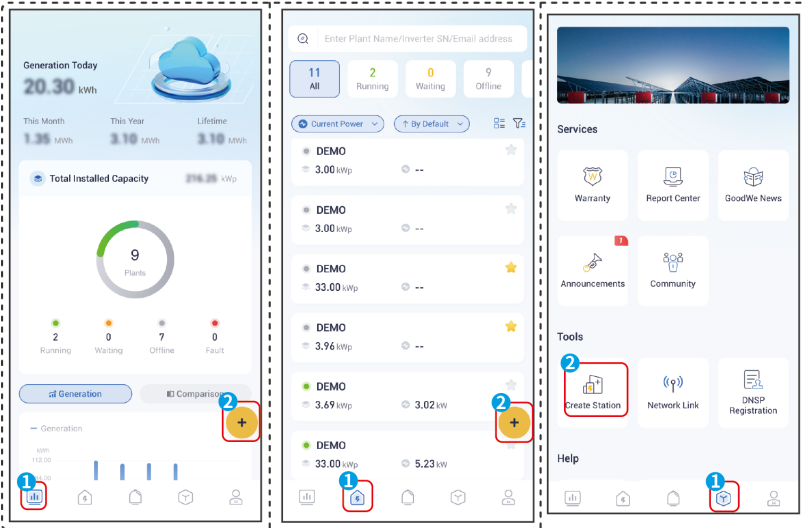

## 9 System Commissioning

### 9.1 Commissioning Method Overview

Please use the SolarGo App to configure the parameters.

### 9.2 SolarGo APP

#### 9.2.1 Product Introduction

#### NOTICE

- All the user interface (UI) screenshots or words in this document are based on **SolarGo app V6.6.0**. The UI may be different due to the version upgrade. The screenshots, words or data are for reference only.
- The method to set parameters is the same for all inverters. But the parameters displayed varies based on the equipment model and safety code. Refer to the actual interface display for specific parameters.
- Before setting any parameters, read through user manual of the App and the inverter or charger to learn the product functions and features. When the inverter parameters are set improperly, the inverter may fail to connect to the utility grid or fail to connect to the utility grid in compliance with related requirements and damage the battery, which will affect the inverter's power generation.

SolarGo App is a mobile application that communicates with the inverter via Bluetooth, WiFi, 4G, or GPRS. Commonly used functions are as follows:

- Check the operating data, software version, alarms of the inverter, etc.
- Set grid parameters and communication parameters of the inverter.
- Set charging mode of the charger.
- Maintain the equipment.

#### 9.2.1.1 Downloading and Installing the App

Make sure that the mobile phone meets the following requirements:

- Mobile phone operating system: Android 5.0 or later, iOS 13.0 or later.
- The mobile phone can access the Internet.
- The mobile phone supports WLAN or Bluetooth.

### NOTICE

After installing the app, it can automatically prompt users to update the app version.

Method 1: Search SolarGo in Google Play (Android) or App Store (iOS) to download and install the app.



Method 2: Scan the QR code below to download and install the app.



### 9.2.1.2 App Connection

Connect as the following shows after powering on the equipment.

### NOTICE

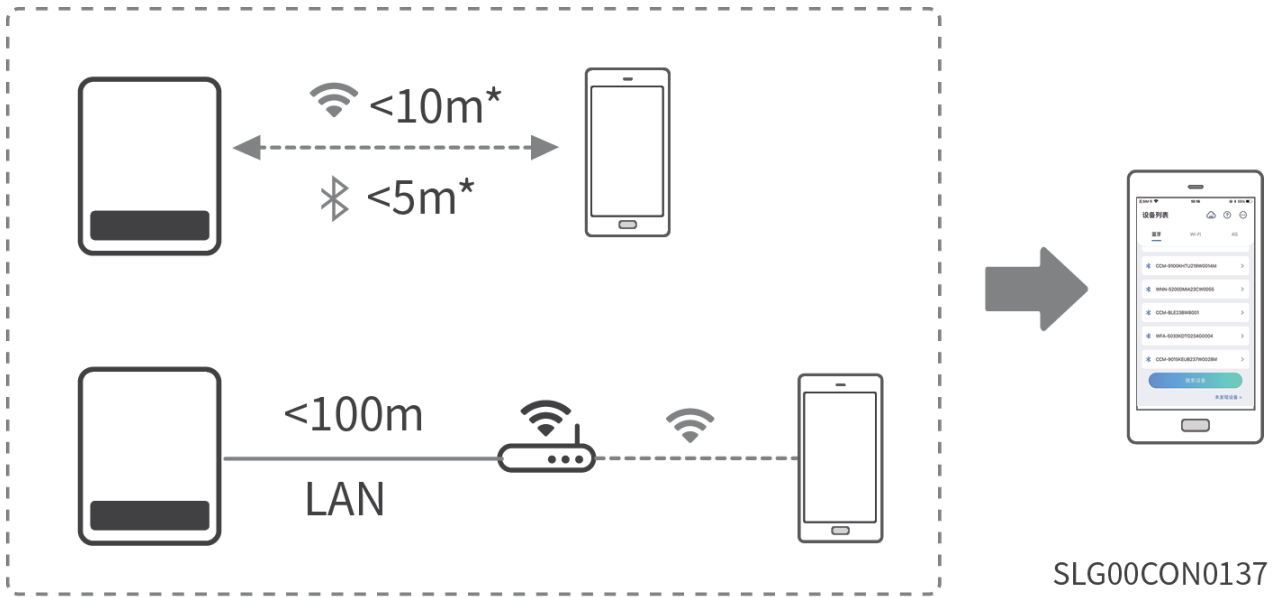

The connection distance varies depending on smart dongles. Refer to the actual used smart dongles.

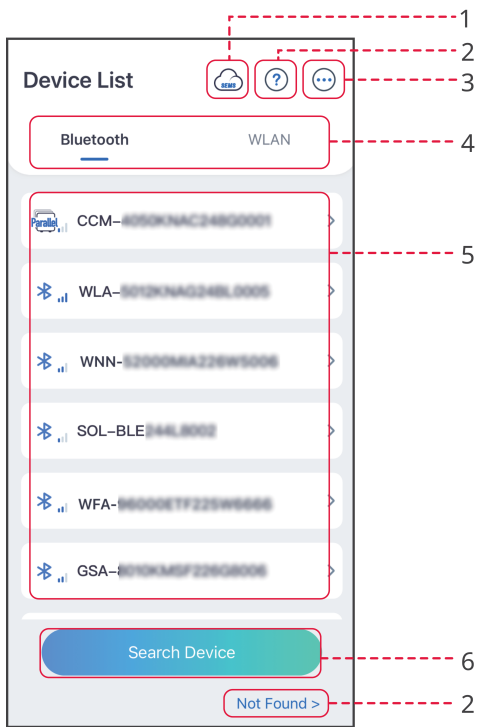

### 9.2.1.3 GUI Introductions to Login Page



No.	Name/Icon	Description
1		Tap the icon to open the page downloading the SEMS Portal app.

No.	Name/Icon	Description
2		Tap to read the connection guide.
	Not found	
3		<ul style="list-style-type: none"> <li>• Check information such as app version, local contacts, etc.</li> <li>• Other settings, such as update date, switch language, set temperature unit, etc.</li> </ul>
4	Bluetooth/WiFi/4G	Select based on actual communication method. If you have any problems, tap  or <b>NOT Found</b> to read the connection guides.
5	Device List	<ul style="list-style-type: none"> <li>• The list of all devices. The last digits of the device name are normally the serial number of the device.</li> <li>• Select the device by checking the serial number of the master inverter when multi inverters are parallel connected.</li> <li>• The device name varies depending on the inverter model or smart dongle model: <ul style="list-style-type: none"> <li>◦ Wi-Fi/LAN Kit, Wi-Fi Kit, Wi-Fi Box: Solar-WiFi***</li> <li>◦ External or integrated bluetooth module: Solar-BLE***</li> <li>◦ WiFi/LAN Kit-20: WLA-***</li> <li>◦ WiFi Kit-20: WFA-***</li> <li>◦ Ezlink3000: CCM-BLE***; CCM-***; ***</li> <li>◦ 4G Kit-CN-G20/4G Kit-CN-G21: GSA-***; GSB-***</li> <li>◦ 4G Kit-G20: GSC-***</li> <li>◦ Micro inverter: WNN***</li> <li>◦ AC Charger: ***</li> </ul> </li> </ul>
6	Search Device	Tap <b>Search Device</b> if the device is not found.

## 9.2.2 Connecting the Hybrid Inverter (Bluetooth)

**Step 1** Ensure that the inverter is power on, both the inverter and the communication module are working properly.

**Step 2** Select **Bluetooth** tab on the SolarGo app homepage.

**Step 3** Pull down or tap **Search Device** to refresh the device list. Find the device by the the inverter serial number. Tap the device name to log into the **Home** page. Select the device by checking the serial number of the master inverter when multi inverters are parallel connected.

**Step 4** For first connection with the equipment via Bluetooth, there will be a Bluetooth pairing prompt, tap **Pair** to continue the connection.

**Step 5** Log in as an Owner or an Installer. Initial password: 1234. Default password: 1234.

**Step 6** (Optional): If connecting via WLA-\*\*\* or WFA-\*\*\*, enable Bluetooth Stays On following the prompts as entering the device details page. Otherwise, the bluetooth signal of the device will be off after disconnection.

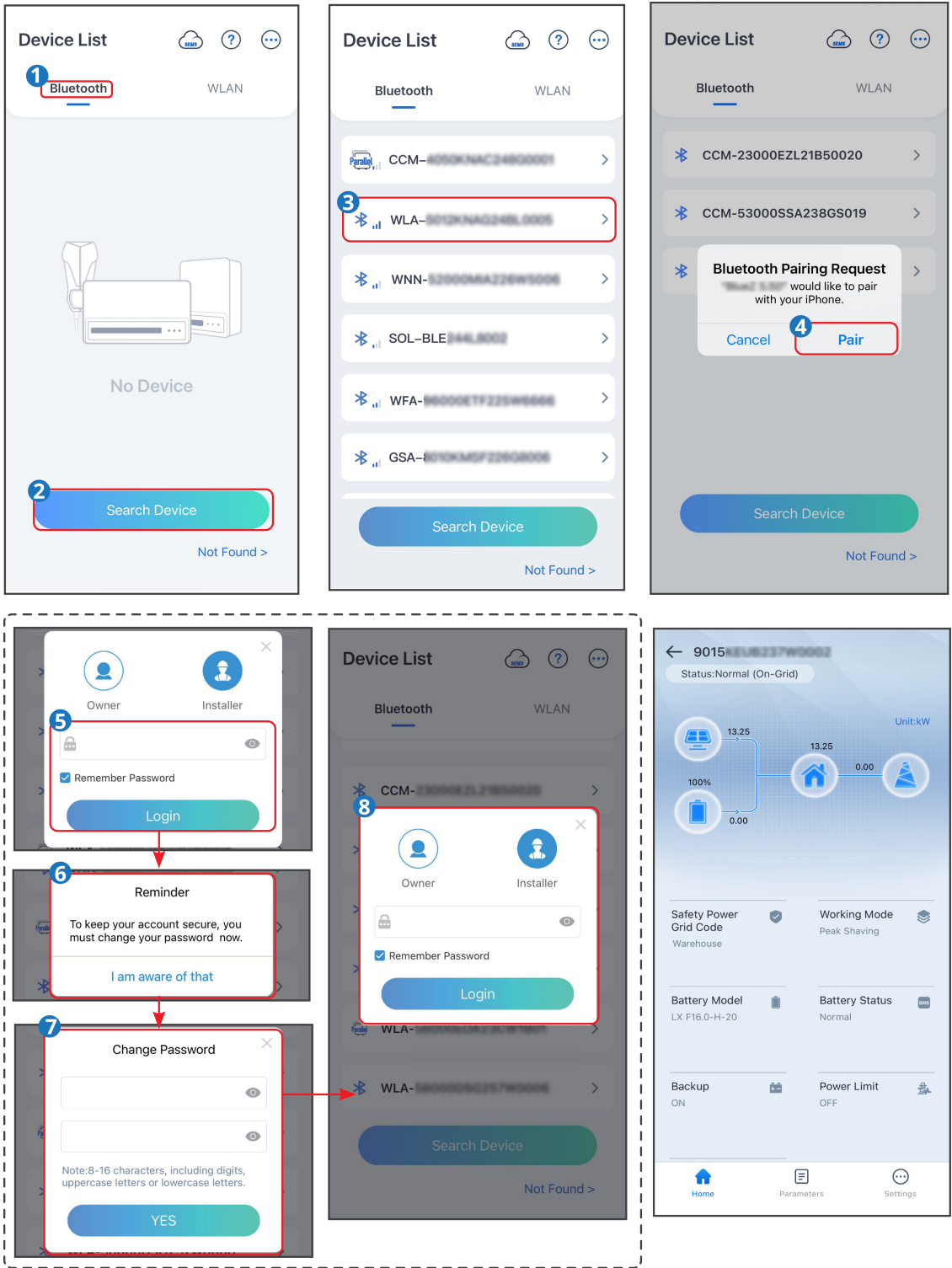

### 9.2.3 Connect the Smart Dongle

When connecting to an inverter via the SolarGo App, if the inverter signal cannot be detected, the device list interface will display the signal of the smart dongle connected to the inverter.

## Supported Smart Dongle types:

- WiFi/LAN Kit-20
- Ezlink3000
- 4G Kit-CN-G20 ; 4G Kit-CN-G21 ; 4G Kit-G20

Step 1: On the homepage of the SolarGo App, find the grayed-out SN number of the smart dongle and click to enter the settings interface.

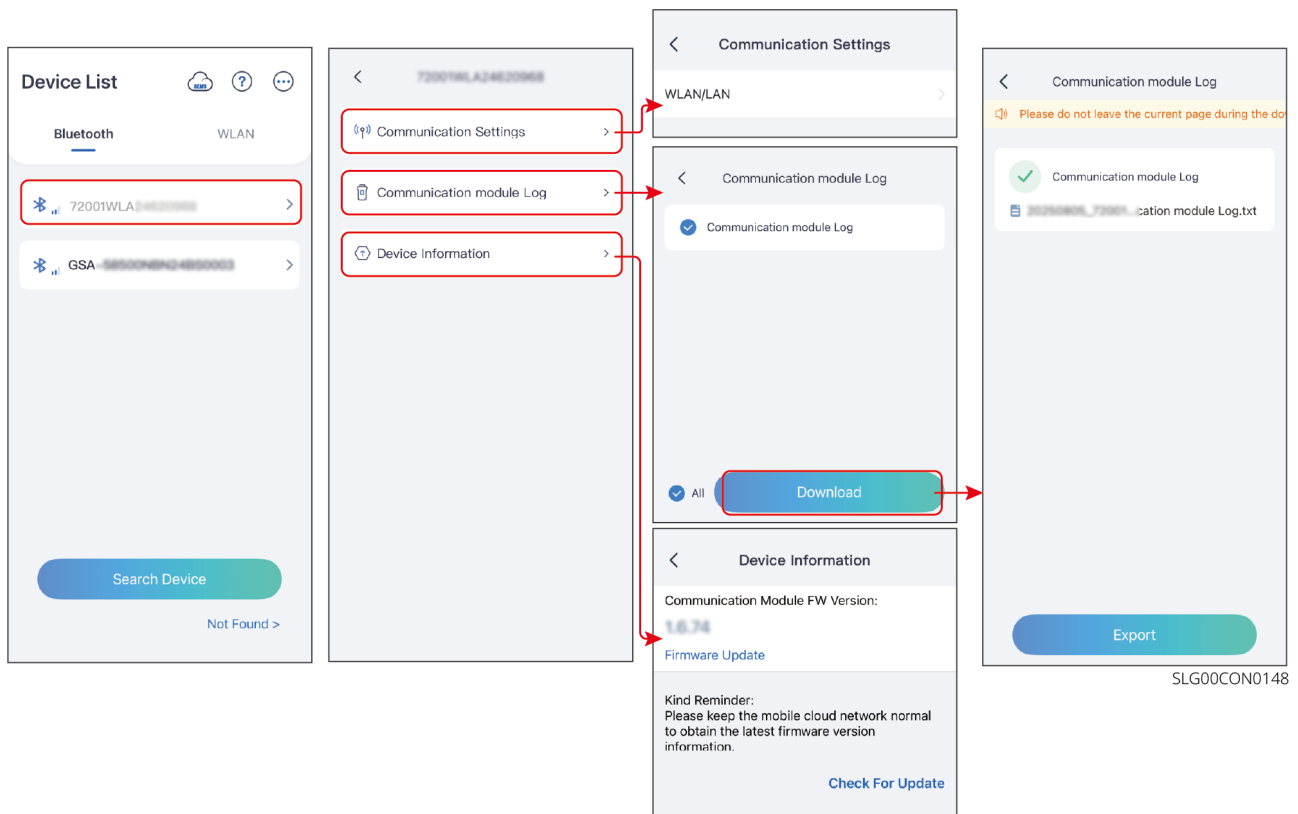

Step 2: Set or query parameter information according to actual needs.

- Communication Configuration: Click to set WLAN/LAN parameters and connect the module to the router.
- Communication Module Logs: Click to enter the module log download interface.
- Device Information: Click to view the firmware version of the smart dongle. If a version update is available, you can refer to the on-screen prompts to complete the update.

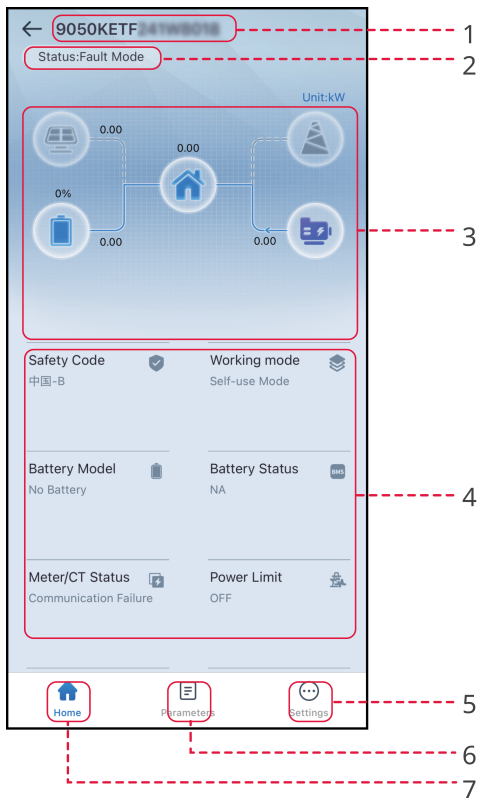

## 9.2.4 GUI Introductions to Hybrid Inverters



No.	Name/Icon	Description
1	Serial Number	Serial number of the connected inverter.
2	Device Status	Indicates the status of the inverter, such as Working, Fault, etc.
3	Energy Flow Chart	Indicates the energy flow chart of the PV system. The actual page prevails.
4	System Status	Indicates the system status, such as Safety Code, Working Mode, Battery Model, Battery Status, Power Limit, Three-Phase Unbalanced Output, etc..
5		Home. Tap Home to check Serial Number, Device Status, Energy Flow Chart, System Status, etc.
6		Parameters. Tap Parameters to check the inverter Data.

No.	Name/Icon	Description
7		<ul style="list-style-type: none"> <li>• Settings Tap to perform quick settings, basic settings, advanced settings, etc. on the inverter.</li> <li>• Login required to access Quick Setup and Advanced Setting. Contact the supplier or after sales service for password. Password for professional technicians only.</li> </ul>

## 9.2.5 Setting Communication Parameters

### NOTICE

The communication configuration interface may be different if the inverter uses different communication modes or connects different communication modules. Please refer to the actual interface.

### 9.2.5.1 Setting Privacy and Security Parameters

#### Type I

**Step 1** : Tap **Home** > **Settings** > **Communication Setting** > **Privacy & Security** to set the parameters.

**Step 2** : Set the new password for the WiFi hotspot of the communication module, and tap **Save**.

**Step 3** Open the WiFi settings of your phone and connect to the inverter's WiFi signal (Solar WiFi\*\*\*) with the new password.

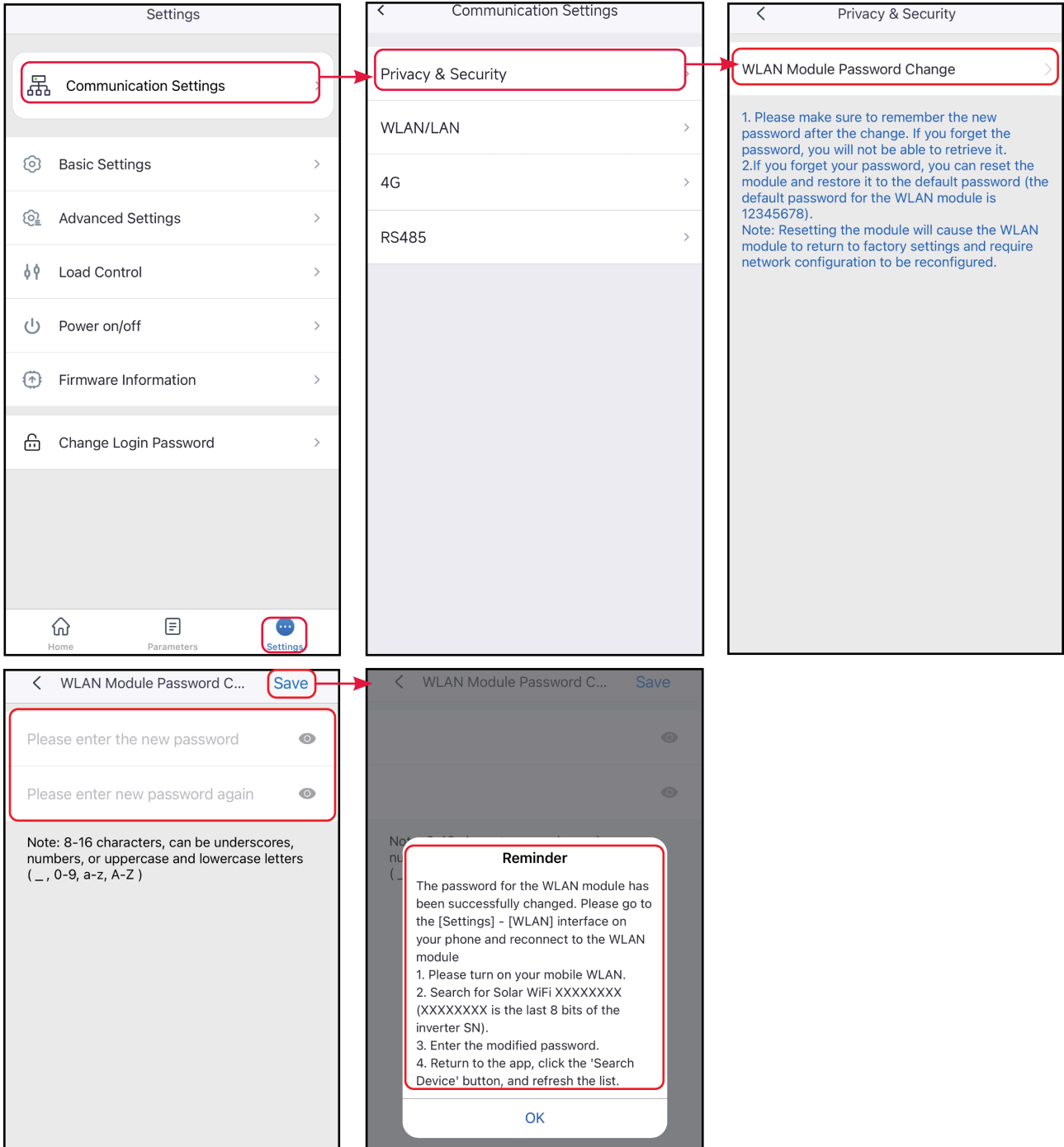

## Type II

**Step 1 :** Tap **Home > Settings > Communication Setting > Privacy & Security** to set the parameters.

**Step 2** Enable Bluetooth Stays On or WLAN Control based on actual needs.

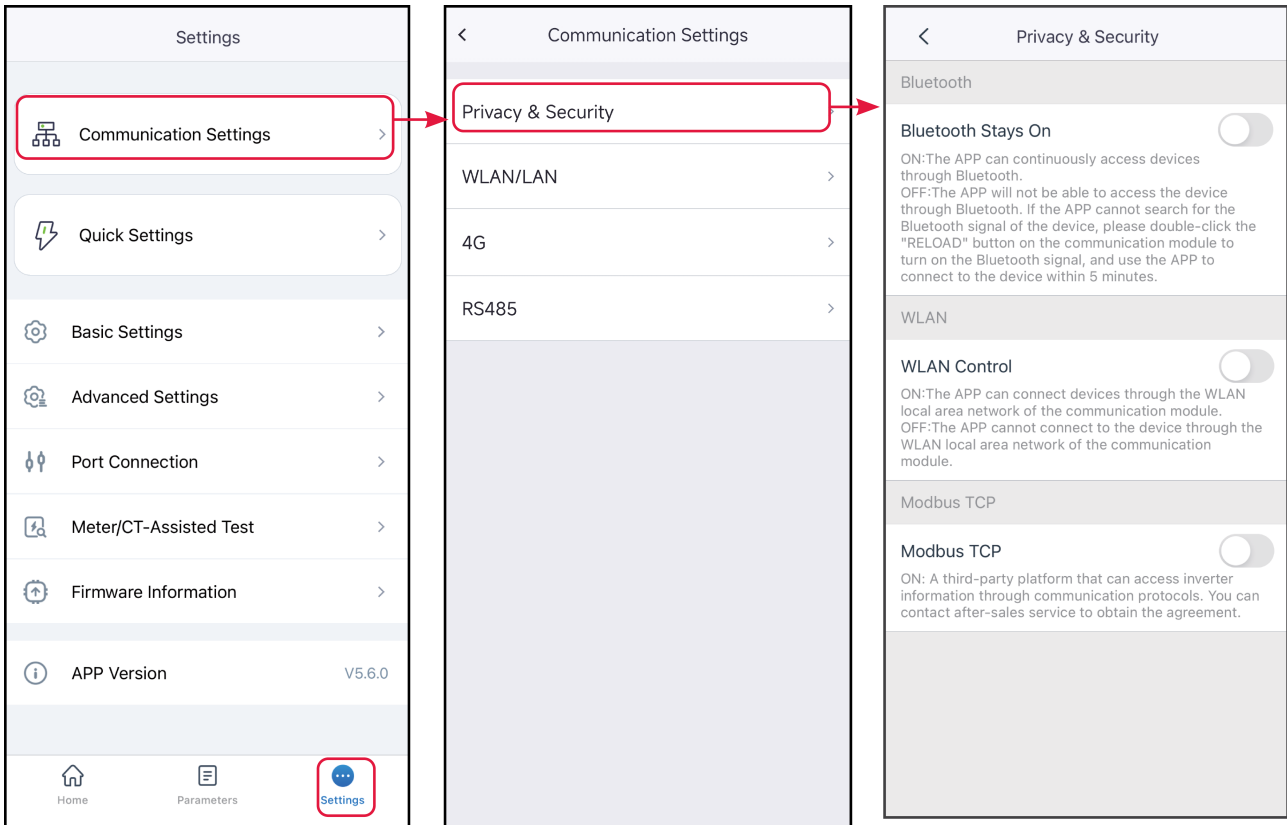

No.	Parameters	Description
1	Bluetooth Stays On	Disabled by default. Enable the function, the bluetooth of the device will be contentious on to keep connected to SolarGo. Otherwise, the bluetooth will be off in 5 minutes, and the device will be disconnected from SolarGo.
2	WLAN Control	Disabled by default. Enable the function, the device and the SolarGo can be connected through the WLAN when they are on the same LAN. Otherwise, they cannot be connected even if they are on the same LAN.
3	Modbus-TCP	Enable the function, the third party monitoring platform can access inverter through Modbus-TCP communication protocol.
4	SSH control Ezlink	After enabling this function, third-party platforms can connect to and control EzLink's Linux system.

### Type III

**Step 1 :** Tap **Home > Settings > Communication Setting > Privacy & Security** to set

the parameters.

**Step 2 : Enable Bluetooth Stays On or Login Password based on actual needs.**

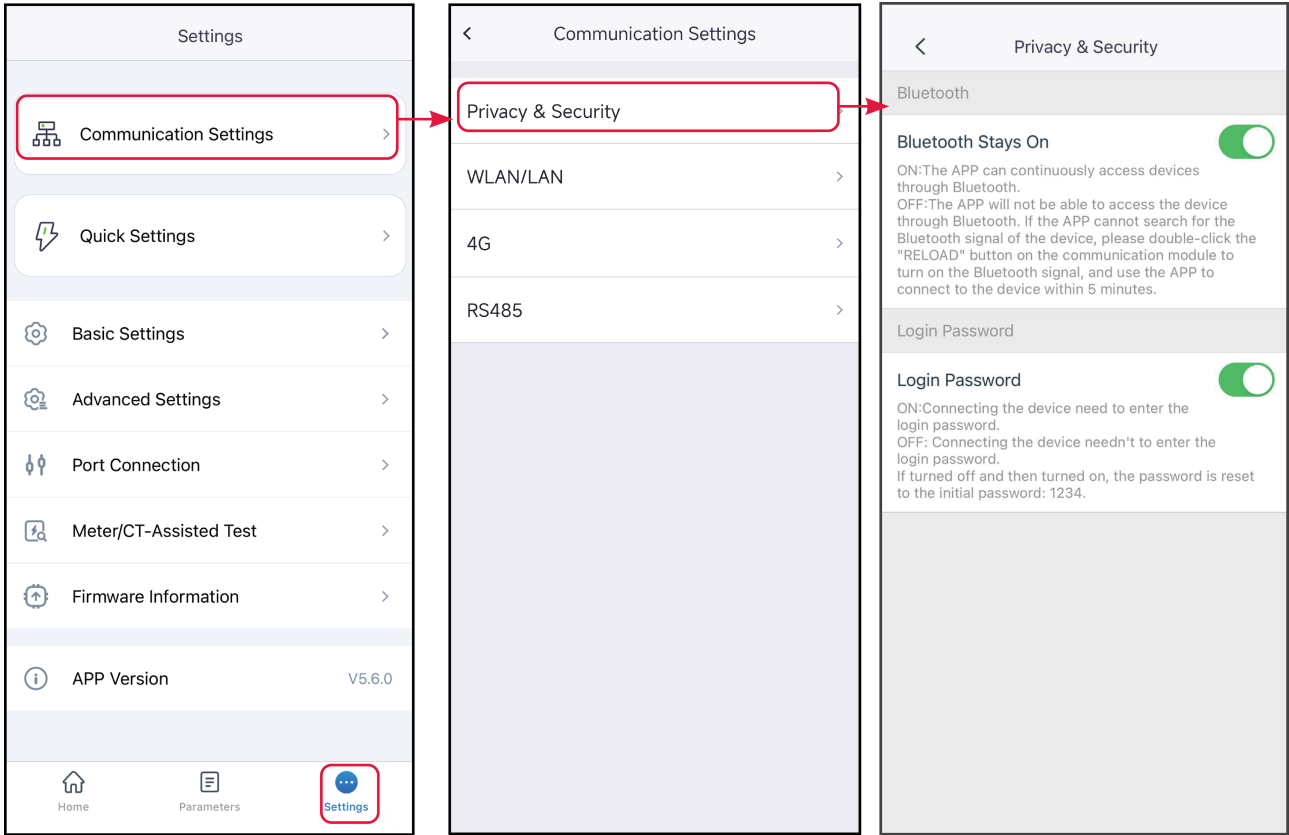

No.	Parameters	Description
1	Bluetooth Stays On	Disabled by default. Enable the function, the bluetooth of the device will be contentious on to keep connected to SolarGo. Otherwise, the bluetooth will be off in 5 minutes, and the device will be disconnected from SolarGo.
2	Password	Disabled by default. Enable the function, you will be prompted to enter the login password when connecting the device to SolarGo. Use the initial password and change it at the first login prompt.

**9.2.5.2 Setting WLAN/LAN Parameters**

## NOTICE

When the inverter is connected to different communication modules, the communication configuration interface may be different. Please refer to the actual interface.

**Step 1 :** Tap **Home > Settings > Communication Setting > WLAN/LAN** to set the parameters.

**Step 2 :** Configure the WLAN or LAN parameters based on actual needs.

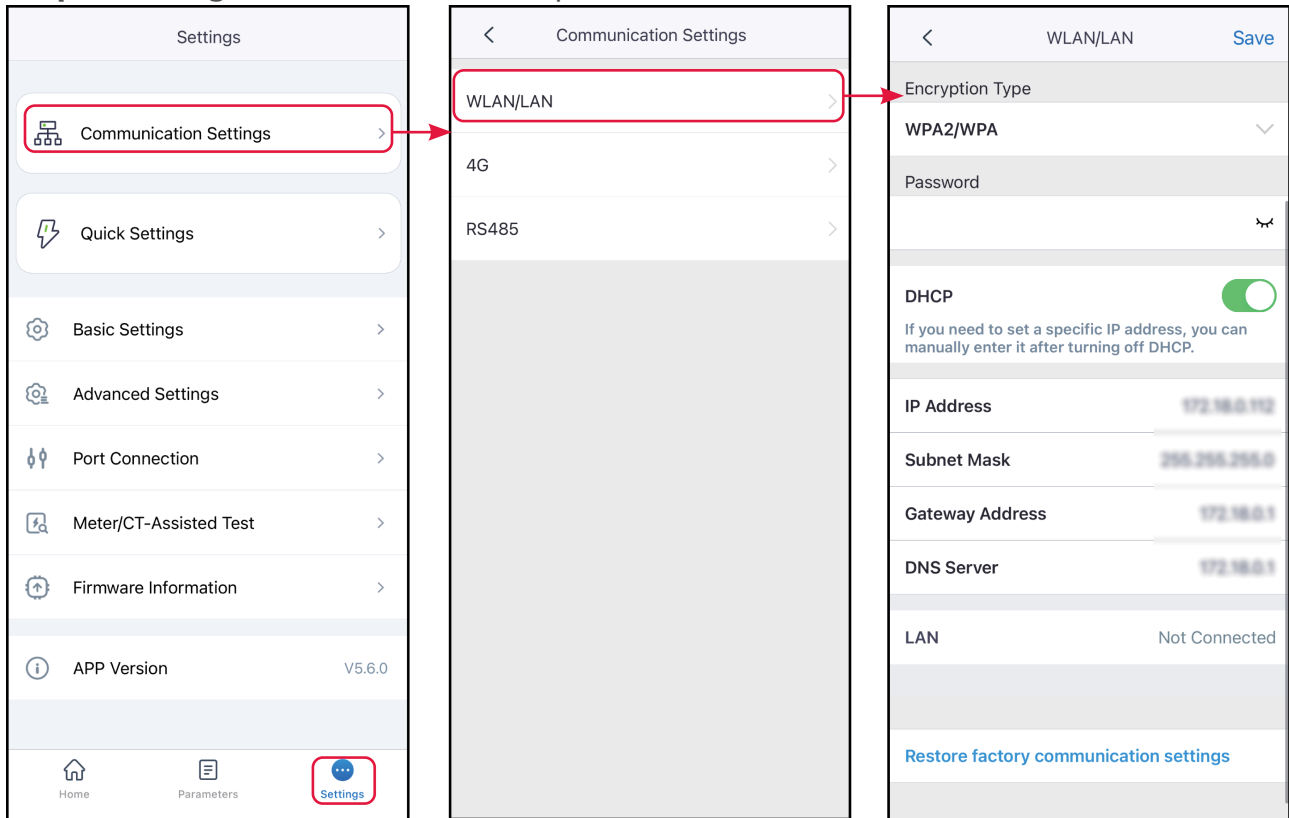

No.	Parameters	Description
1	Network Name	Only for WLAN. Select WiFi based on the actual connecting.
2	Password	Only for WLAN. WiFi password for the actual connected network.
3	DHCP	Enable DHCP when the router is in dynamic IP mode. Disable DHCP when a switch is used or the router is in static IP mode.

No.	Parameters	Description
4	IP Address	Do not configure the parameters when DHCP is enabled. Configure the parameters according to the router or switch information when DHCP is disabled.
5	Subnet Mask	
6	Gateway Address	
7	DNS Server	

### 9.2.5.3 Configuring RS485 Parameters

#### NOTICE

Set the communication address of the inverter. For a single inverter, the address is set based on actual needs. For multi connected inverters, the address of each inverter should be different while cannot be 247.

**Step 1:** Tap **Home > Settings > Communication Settings > RS485** to set the parameters.

**Step 2 :** Set the Modbus Address And Baud Rate base on actual situation.

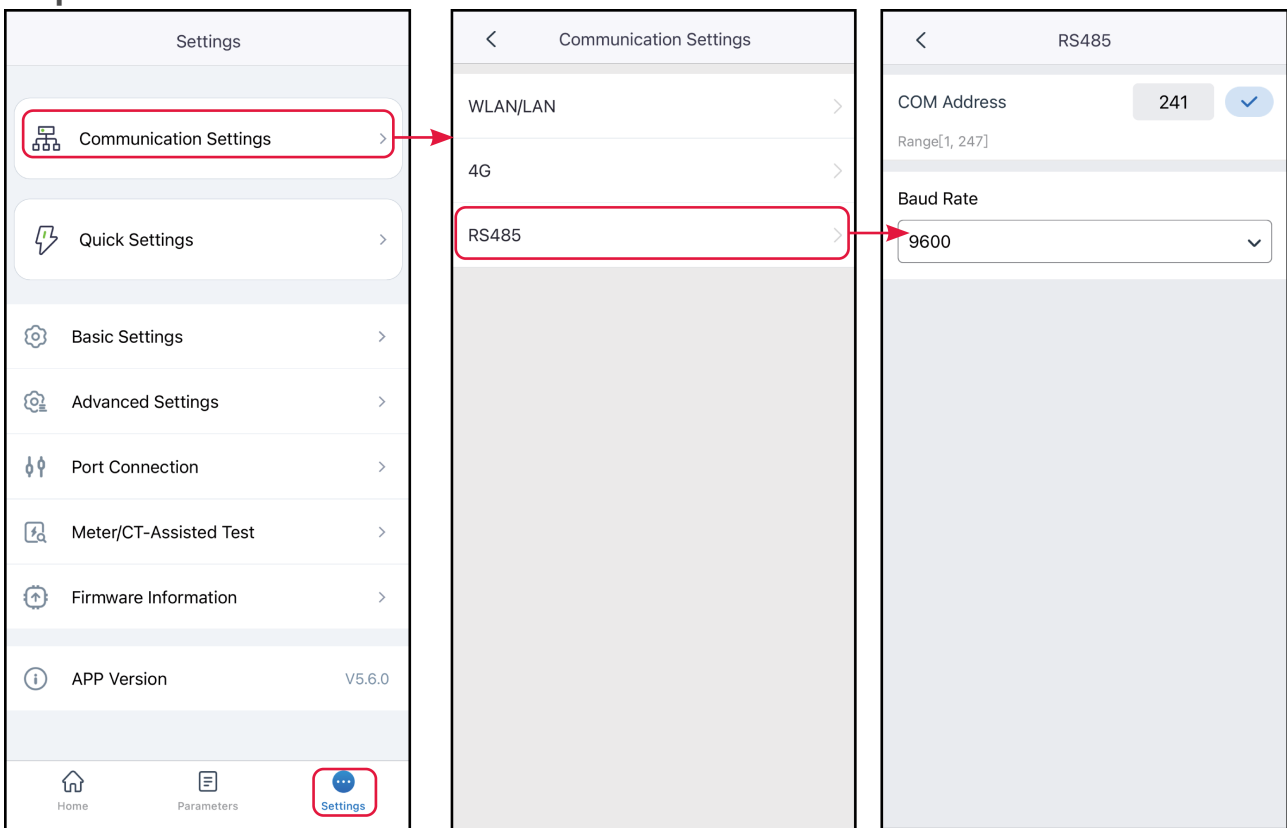

## 9.2.6 Setting Up the RS485 Parallel System

### NOTICE

- When paralleling hybrid inverters via RS485, you must set each inverter as the master or slave inverter individually using the SolarGo App.
- When an inverter in a parallel system needs to be used as a single unit, it must be set to standalone inverter via the SolarGo App.
- Please set the inverter connected to the meter as the master.
- Please first set the slave inverter address, then set the parallel network through the master.

**Step 1:** Go to the settings interface via **Settings > Parallel System Settings** .

**Step 2:** Set the inverter to Master, Slave, or Stand-alone based on its actual wiring.

- If the inverter is the master, set it to Master and then exit the connection. After setting the slave inverter address, return to this interface, click **Parallel Networking**, set the number of inverters in the parallel system, and then click **Network**.
- If the inverter is the slave, set the **Inverter Address** and click ✓.

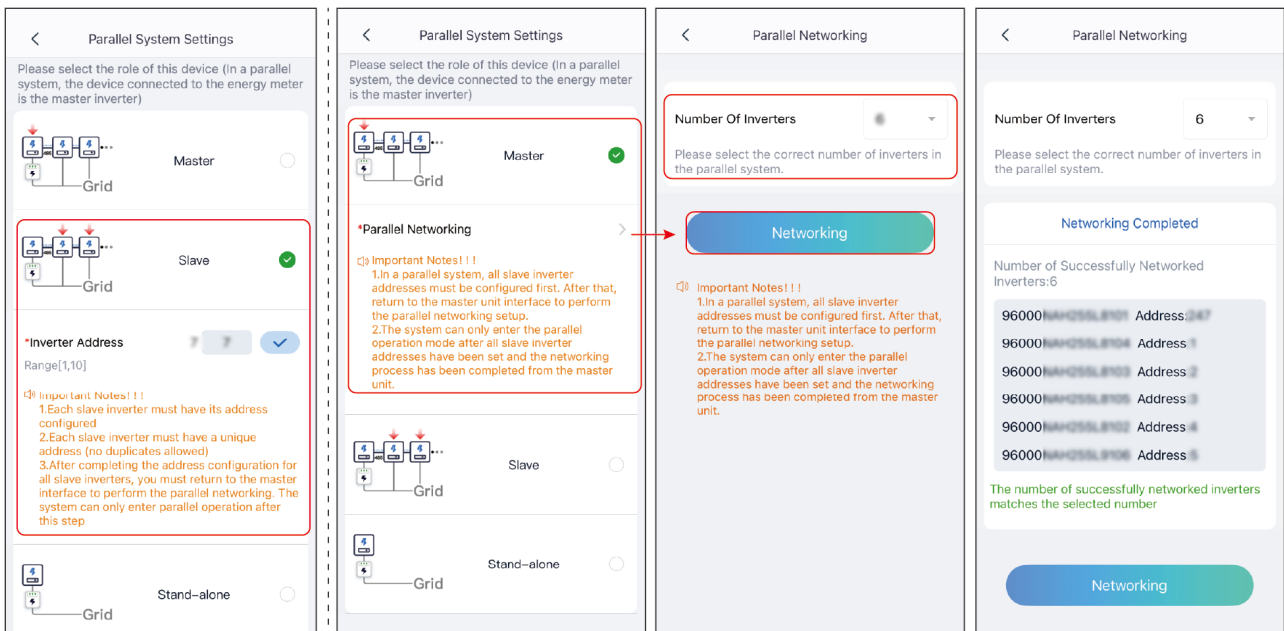

SLG00CON0188

## 9.2.7 Quick Setting the Basic Information

## NOTICE

- The setting page varies depending on inverter model.
- The parameters will be configured automatically after selecting the safety country/region, including overvoltage protection, undervoltage protection, overfrequency protection, underfrequency protection, voltage/frequency connection protection,  $\cos\phi$  curve, Q(U) curve, P(U) curve, FP curve, HVRT, LVRT, etc. Tap Home > Settings > Advanced Settings > Safety Parameters to check the parameters after selecting the safety country.
- The power generation efficiency is different in different working modes. Set the working mode according to the local requirements and situation.
  - Self-use mode: The basic working mode of the system. PV power generation is used to supply power to the load first, the excess power is used to charge the battery, and the remaining power is sold to the grid. When PV power generation cannot meet the load's power demand, the battery will supply power to the load; when the battery power also cannot meet the load's power demand, the grid will supply power to the load.
  - Back-up mode: The back-up mode is mainly applied to the scenario where the grid is unstable. When the grid is disconnected, the inverter turns to off-grid mode and the battery will supply power to the load; when the grid is restored, the inverter switches to grid-tied mode.
  - Economic mode: It is recommended to use economic mode in scenarios when the peak-valley electricity price varies a lot. Select Economic mode only when it meets the local laws and regulations. Set the battery to charge mode during Vally period to charge battery with grid power. And set the battery to discharge mode during Peak period to power the load with the battery.
  - Off-grid mode: suitable for areas without power grid. PV and batteries form a pure off-grid system. PV generates electricity to power the load and excess electricity charges the battery. When PV power generation cannot meet the power demand of the load, the battery will supply power to the load.
  - Smart charging: In some countries/regions, the PV power feed into the utility grid is limited. Select Smart Charging to charge the battery using the surplus power to minimize PV power waste.
  - Peak shaving mode: Peak shaving mode is mainly applicable to peak power limited scenarios. When the total power consumption of the load exceeds the power consumption quota in a short period of time, battery discharge can be used to reduce the power exceeding the quota.

### 9.2.7.1 Quick Setting the Basic Information(Type I)

**Step 1:** Tap **Home** > **Settings** > **Quick Settings** to set the parameters.

**Step 2 :** Enter the password for quick settings. Contact the supplier or after sales service for password. Password for professional technicians only.

**Step 3 :** Some models support one-click configuration. Select **Guided Mode** to quickly configure the system.

**Step 4:** Select Grid Code(Safety Code)accordingly. Tap **Next** to set the Working Mode.

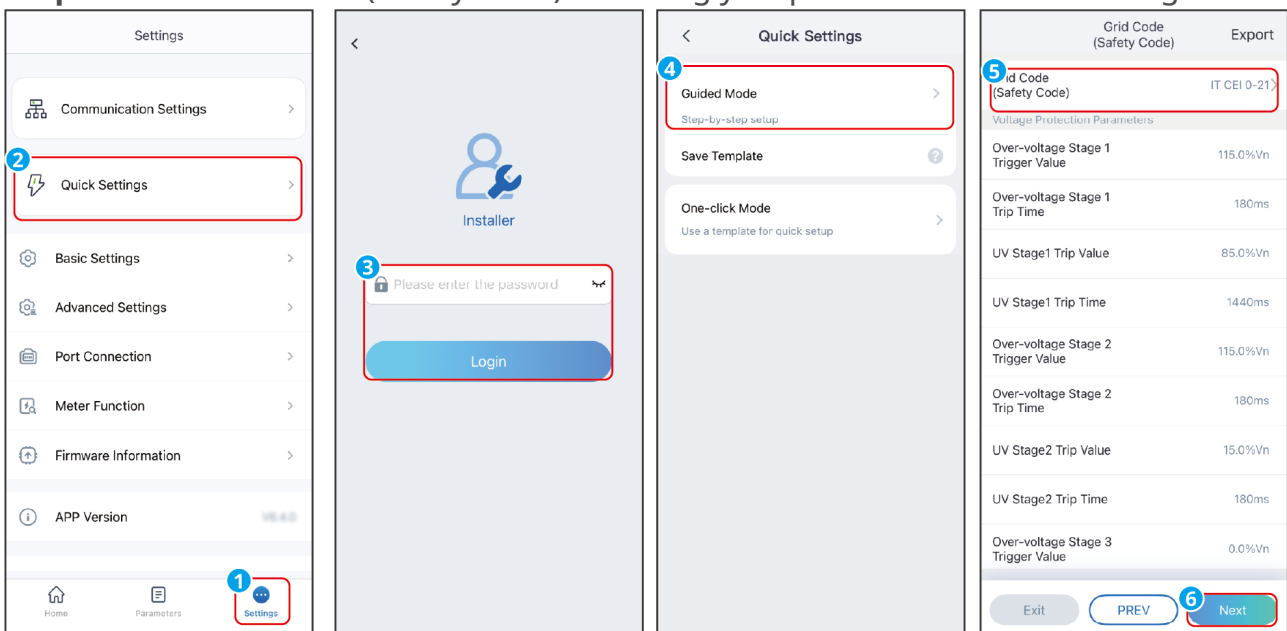

SLG00CON0121

**Step 5:** Set the working mode based on actual needs. Tap **Next** to set the Working Mode. For some models, after the working mode configuration is completed, it will automatically enter the CT/meter self-test state. At this time, the inverter will temporarily disconnect from the grid and then automatically reconnect.

**Step 6 :** Select the battery based on actual situation whether it is **First Installation**, **Routine Operation** or **Replacement Installation**.

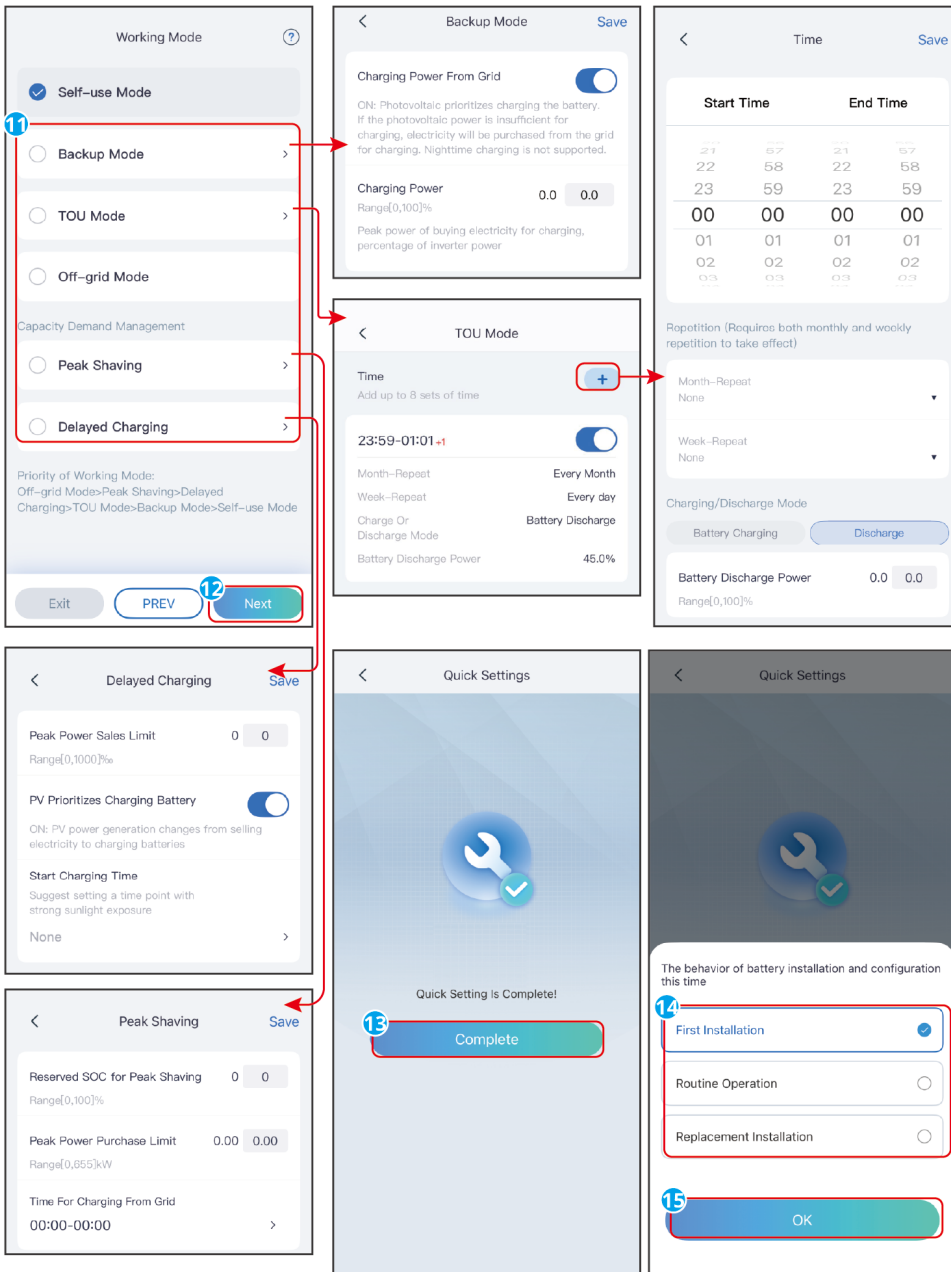

SLG00CON0060

No.	Parameters	Description
Back-up mode		
1	Charging Power From Grid	Enable Charging Power From Grid to allow power purchasing from the utility grid.
2	Charging Power	The percentage of the purchasing power to the rated power of the inverter.
TOU mode		

No.	Parameters	Description
3	Start Time	Within the Start Time and End Time, the battery is charged or discharged according to the set Battery Mode as well as the Rated Power.
4	End Time	
5	Charge Discharge Mode	Charge or discharge according to actual needs.
6	Rated Power	The percentage of the charging/discharging power to the rated power of the inverter.
7	Charge Cut-off SOC	The battery stop charging/discharging once the battery SOC reaches Charge Cut-off SOC.
Peakshaving		
8	Reserved SOC For Peakshaving	In Peak Shaving mode, the battery SOC should be lower than Reserved SOC For Peakshaving. Once the battery SOC is higher than Reserved SOC For Peakshaving, the peak shaving mode fails.
9	Peak Power Purchase Limit	Set the maximum power limit allowed to purchase from the grid. When the loads consume power exceed the sum of the power generated in the PV system and Peak Power Purchase Limit, the excess power will be made up by the battery.
10	Time for Charging From Grid	The utility grid will charge the battery between Start Time and End Time if the load power consumption do not exceed the power quota. Otherwise, only PV power can be used to charge the battery. Otherwise, only PV power can be used to charge the battery.
Smart charging		
11	Peak Power Sales Limit	Set the Peak Power Sales Limit in compliance with local laws and regulations. The Peak Limiting Power shall be lower then the output power limit specified by local requirements.
12	PV Prioritizes Charing Battery	During charging time, the PV power will first charge the battery.

No.	Parameters	Description
13	Start Charging Time	

**Step 7 :** For devices that support one-click configuration, a template can be generated based on the completed configuration.

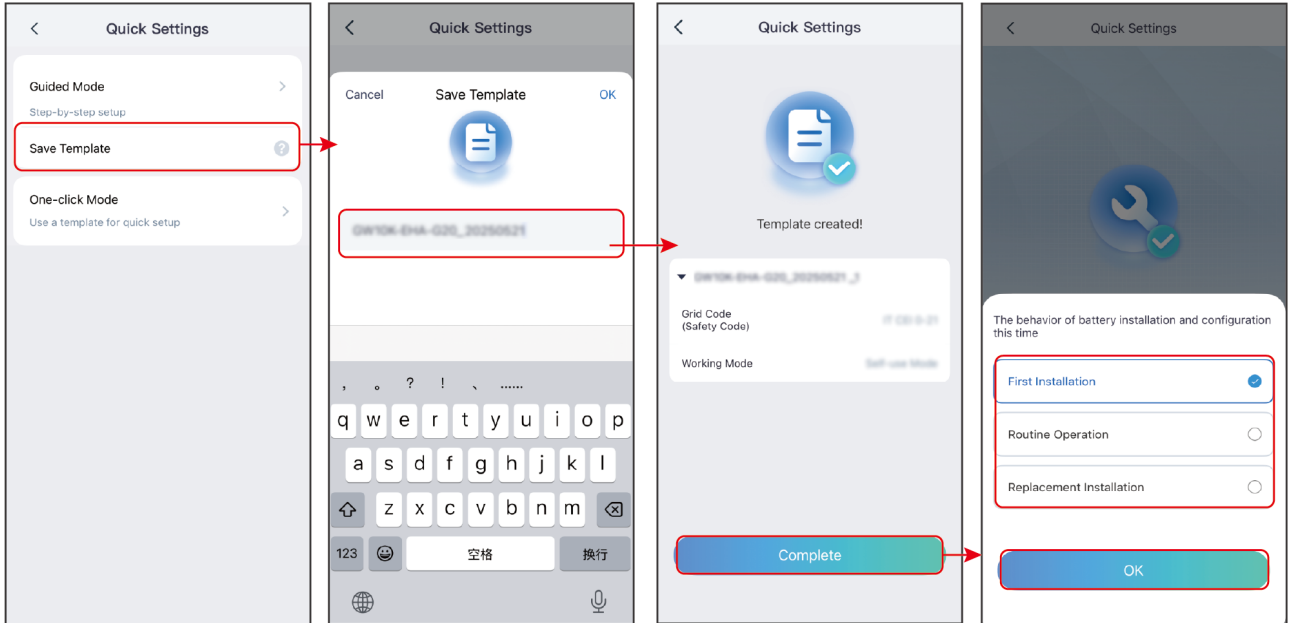

SLG00CON0119

**Step 8:** If you already have a one-click configuration template, you can use the existing template direct import mode to quickly complete the configuration.

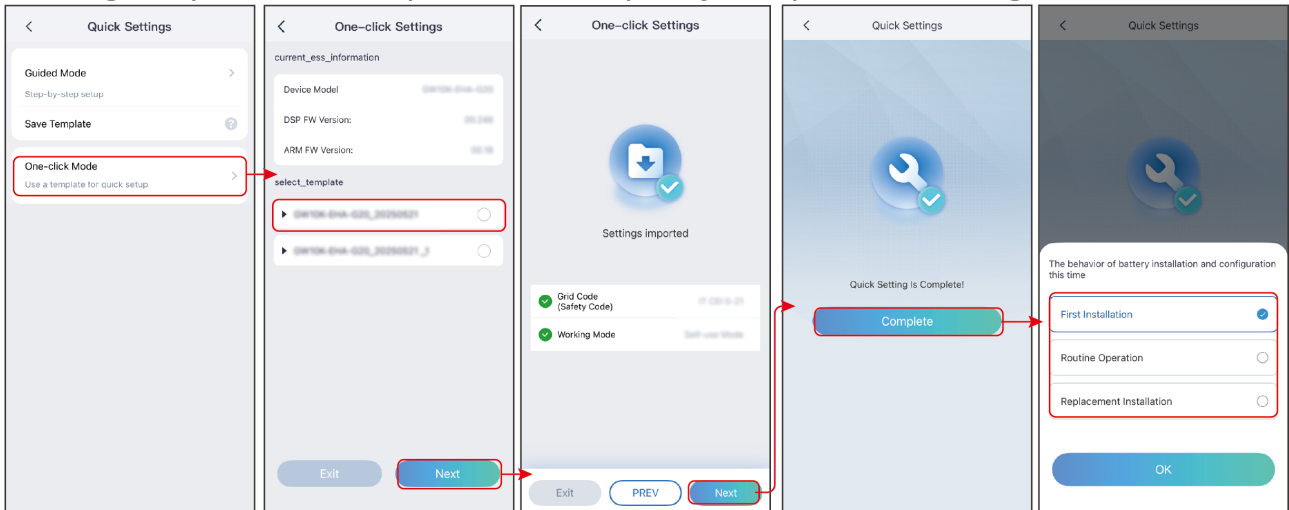

SLG00CON0120

## 9.2.8 Setting the Basic Information

### 9.2.8.1 Setting the SPD

After enabling SPD, when the SPD module is abnormal, there will be SPD module abnormal alarm prompt.

**Step 1 :** Tap **Home > Settings > Basic Settings > SPD**, to set the parameters.

**Step 2 :** enable or disable the function based on actual needs.

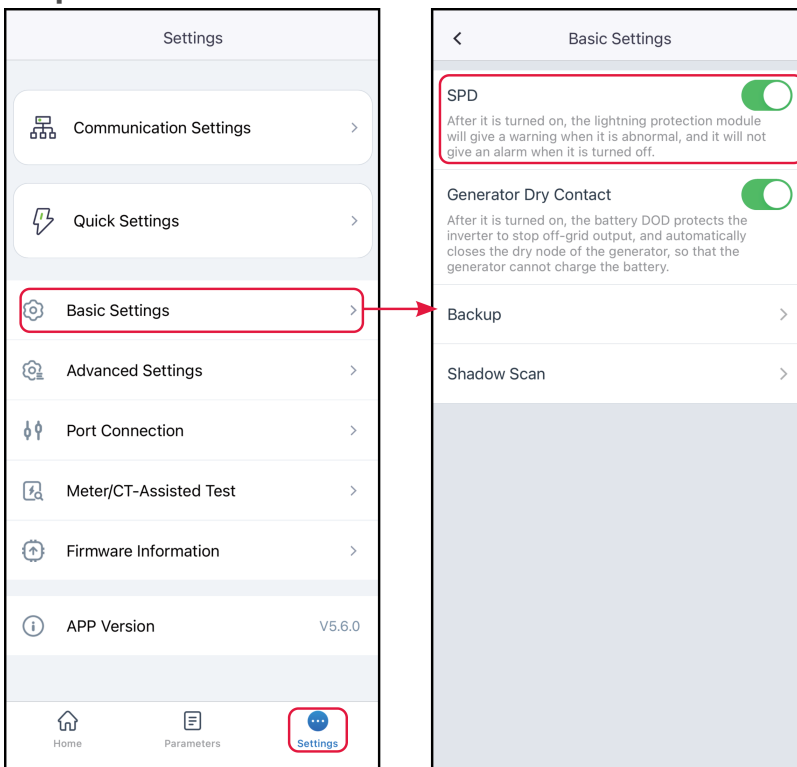

### 9.2.8.2 Setting the Back-up Power Parameters

After enabling Backup, the battery will power the load connected to the backup port of the inverter to ensure Uninterrupted Power Supply when the power grid fails.

**Step 1 :** Tap **Home > Settings > Basic Settings > Backup**, to set the parameters.

**Step 2 :** Set the backup supply function based on actual needs.

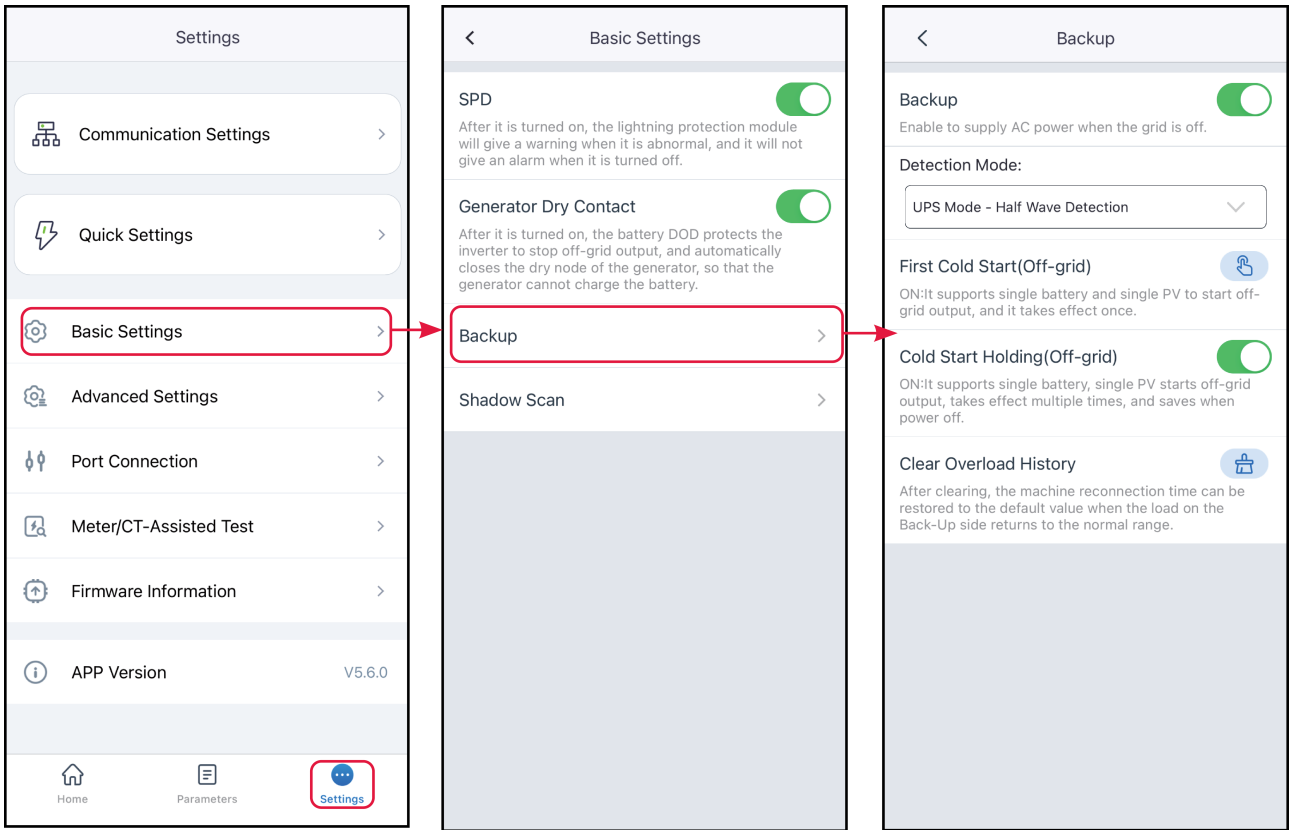

No.	Parameters	Description
1	UPS Mode- Full Wave Detection	Check whether the utility grid voltage is too high or too low.
2	UPS Mode- Half Wave Detection	Check whether the utility grid voltage is too low.
3	EPSmode-with LVRT support.	Stop detecting utility grid voltage.
4	First Cold Start (Off-grid)	It will only take effect once. In off-grid mode, enable First Cold Start (Off-grid) to output backup supply with battery or PV.
5	Cold Start Holding (Off-grid)	Take effect multiple times. In off-grid mode, enable First Cold Start (Off-grid) to output backup supply with battery or PV.

No.	Parameters	Description
6	Clear Overload History	Once the power of loads connected to the inverter BACK-UP ports exceeds the rated load power, the inverter will restart and detect the power again. The inverter will perform restart and detection several times until the overloading problem is solved. Tap Clear Overload History to reset the restart time interval after the power of the loads connected to the BACK-UP ports meets the requirements. The inverter will restart immediately.

### 9.2.8.3 Setting the Shadow Scan

Enable Shadow Scan when the PV panels are severely shadowed to optimize the power generation efficiency.

**Step 1 :** Tap **Home > Settings > Basic Settings> Shadow Scan**, to set the parameters.

**Step 2:** Enable or disable the function based on actual needs. Set the Shadow Scan interval and MPPT shadow scan if the inverter supports.

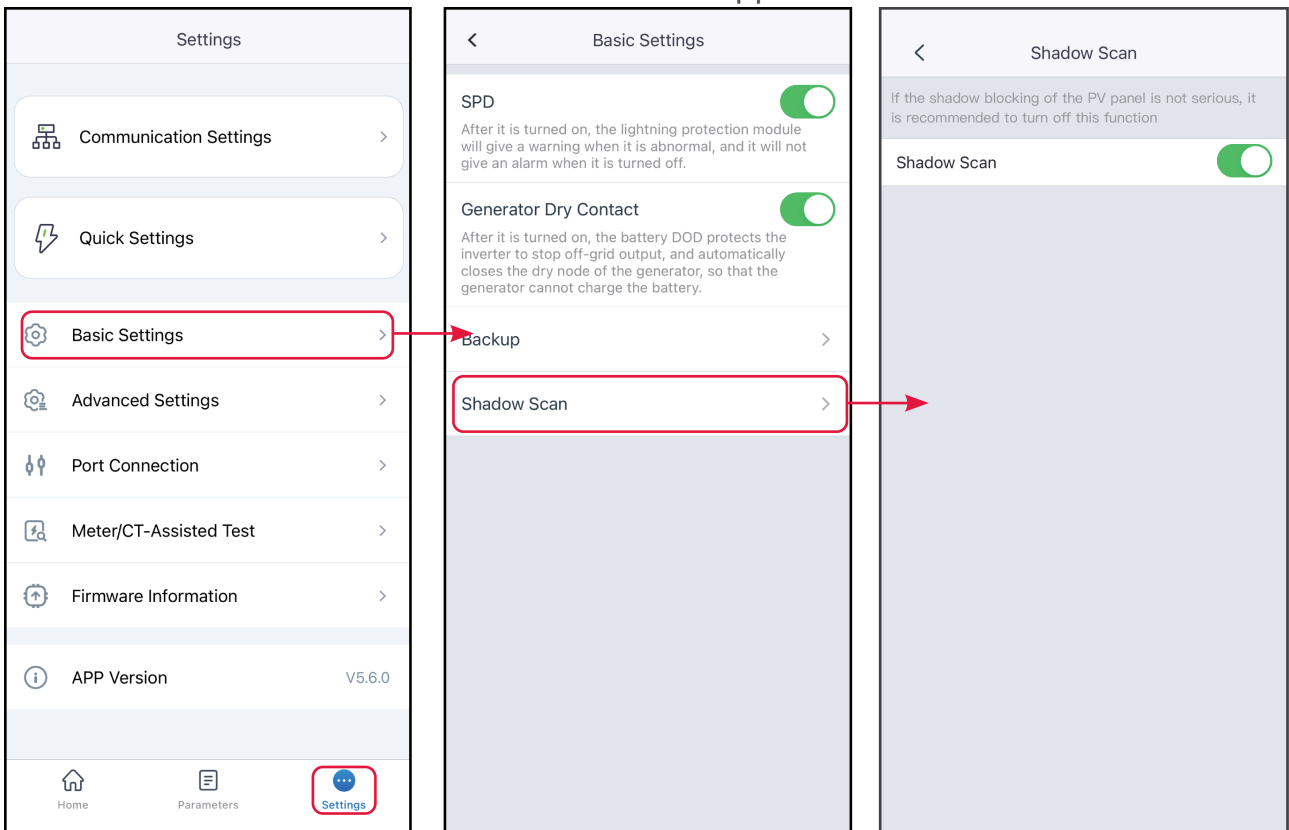

### 9.2.8.4 Setting Power Adjustment Parameters

**Step 1:** Go to the settings interface via **Home > Settings > Basic Settings > Power Scheduling**.

**Step 2:** Set the active power dispatch or reactive power dispatch parameters according to the actual situation.

The screenshot shows the 'Active Dispatch' settings page. At the top, there is a back arrow and the title 'Active Dispatch'. Below the title, there is a description: 'Local control: Self-control according to user needs; Remote control: Passive control according to the requirements of the power grid (enabled by default)'. The 'Current Active Power Dispatch Mode' is set to 'Active Power (W)'. The 'Extreme Speed Percentage Derating(Remote)' is set to '100.0%'. Under the 'Local Control' section, the 'Active Dispatch Mode' is set to 'Active Power (W)'. At the bottom, the 'Active Power' is set to '11000' with a confirmation button and a range of '[-400000,400000]W'.

The screenshot shows the 'Reactive Scheduling' settings page. At the top, there is a back arrow and the title 'Reactive Scheduling'. Below the title, there is a description: 'Local control: Self-control according to user needs; Remote control: Passive control according to the requirements of the power grid (enabled by default)'. The 'Reactive Power Dispatch Mode' is set to 'Disable'. Under the 'Local Control' section, the 'Select Mode' is set to 'Disable'. Below this, there are three options: 'Fixed Value Compensation', 'Percentage Compensation', and 'PF Compensation'.

SLG00CON0124

No.	Parameter	Description
Active Scheduling		
1	Active Scheduling Mode	<p>According to the requirements of the power grid company in the country/region where the inverter is located, control the active power according to the selected dispatch mode. Supports:</p> <ul style="list-style-type: none"> <li>• Disabled: Disables active scheduling.</li> <li>• Fixed value reduction: Dispatch according to a fixed value.</li> <li>• Percentage reduction: Dispatch based on a percentage of the rated power.</li> </ul>
2	Active Power	<ul style="list-style-type: none"> <li>• When the active power dispatch mode is set to fixed value derating, the active power is set to a fixed value.</li> <li>• When the active power dispatch mode is set to percentage derating, the active power is set as a percentage of the rated power. 比。</li> </ul>
Reactive Scheduling		
3	Reactive Scheduling Mode	<p>According to the requirements of the power grid company in the country/region where the inverter is located, control the reactive power according to the selected dispatch mode. Supports:</p> <ul style="list-style-type: none"> <li>• Disabled: Disables reactive scheduling.</li> <li>• Fixed value compensation: Dispatch according to a fixed value.</li> <li>• Percentage compensation: Dispatch based on a percentage of the rated power.</li> <li>• PF compensation.</li> </ul>
4	Status	Set the power factor as lagging or leading based on actual needs and local grid standards and requirements.

No.	Parameter	Description
5	Reactive Power	<ul style="list-style-type: none"> <li>When the reactive power dispatch mode is set to fixed value derating, the reactive power is set to a fixed value.</li> <li>When the reactive power dispatch mode is set to percentage derating, the reactive power is set as a percentage of the rated power.</li> </ul>
6	Power Factor	When the reactive power dispatch mode is set to PF compensation, set the power factor.

## 9.2.9 Setting Advanced Parameters

### NOTICE

Contact the supplier or after sales service for Advanced Setting password.  
Password for professional technicians only.

### 9.2.9.1 Setting DRED/Remote Shutdown/RCR/EnWG 14a

Enable DRED/Remote Shutdown/RCR before connecting the third party DRED, remote shutdown, or RCR device to comply with local laws and regulations.

**Step 1** : Tap **Home > Settings > Advanced Settings > DRED/Remote Shutdown/RCR** to set the parameters.

**Step 2** : Enable or disable the function based on actual needs.

**Step 3** : For areas where the EnWG 14a regulation applies, when enabling the RCR function, you need to select the RCR mode according to the actual device type and set the DI port power.

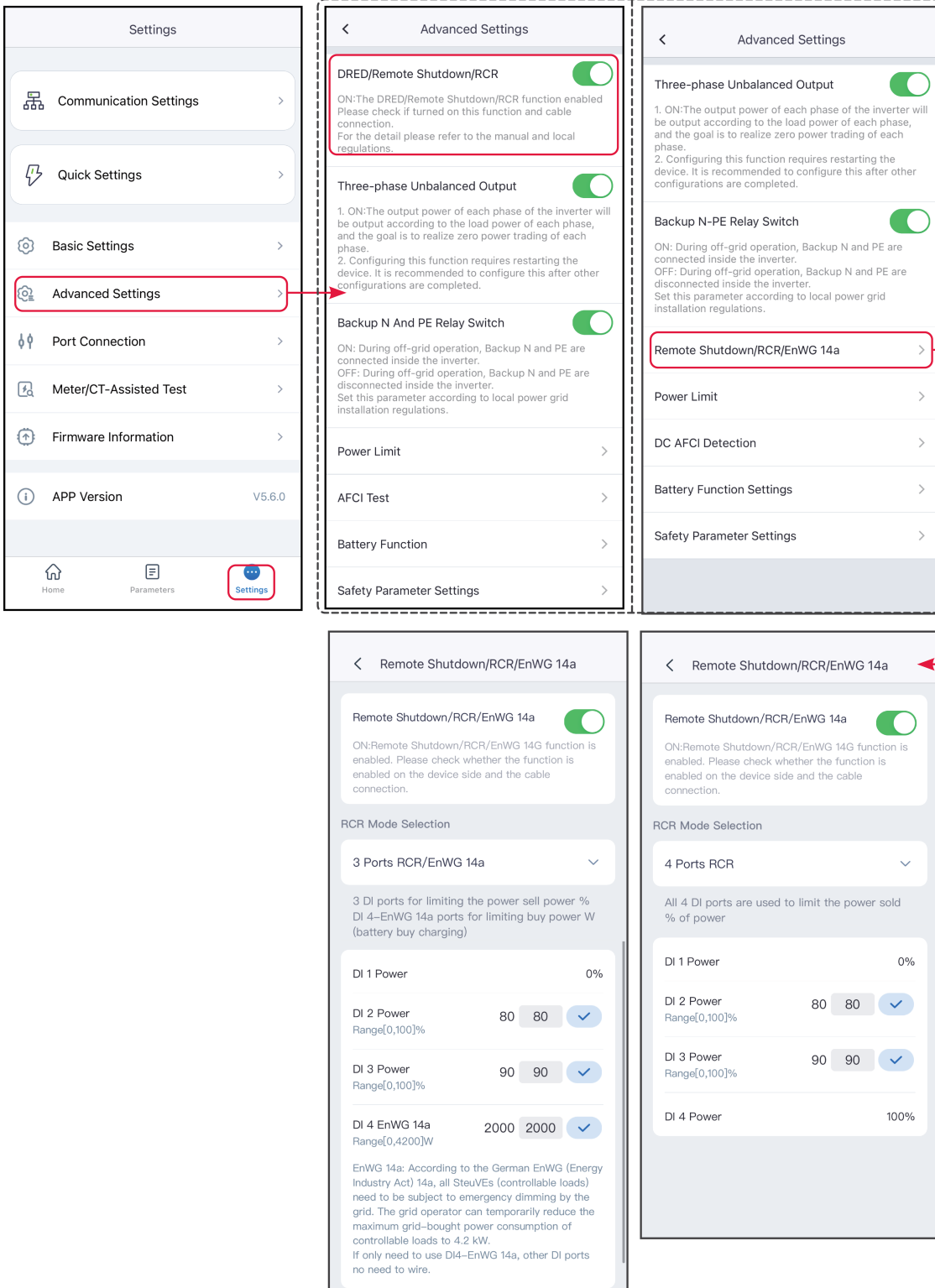

### 9.2.9.2 Setting the Backup N and PE Relay Switch

To comply with local laws and regulations, ensure that the relay inside the back-up

port remains closed and the N and PE wires are connected when the inverter is working off-grid.

**Step 1 :** Tap **Home > Settings > Advanced Settings > Backup N and PE Relay Switch** to set the parameters.

**Step 2 :** Enable or disable the function based on actual needs.

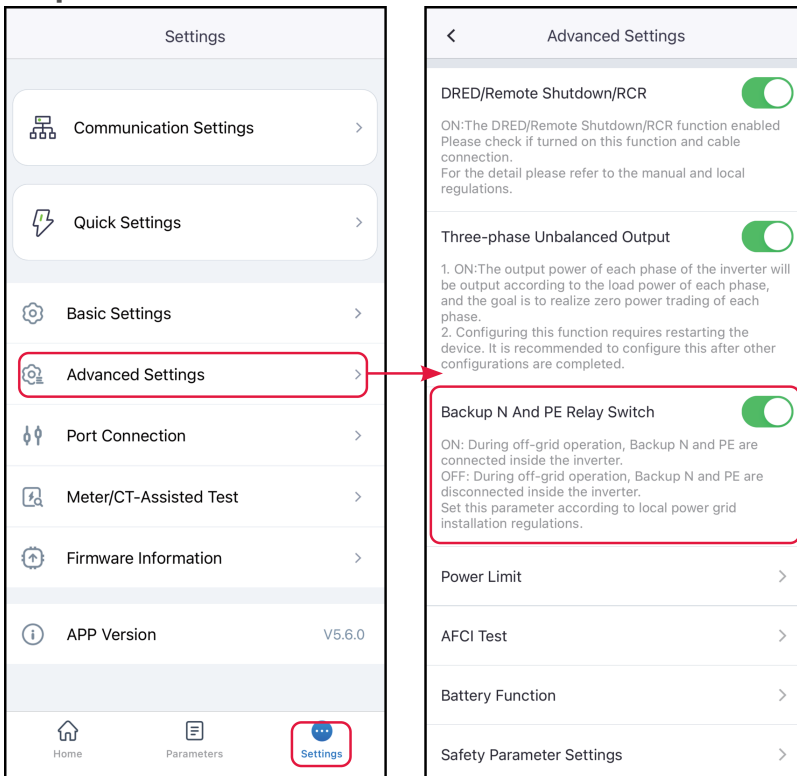

### 9.2.9.3 Setting the Power Limit Parameters

**Step 1:** Tap **Home > Settings > Advanced Settings > Power Limit** to set the parameters.

**Step 2 :** Turn on or off the power limit function according to actual needs.

**Step 3 :** After turning on the function, enter the parameter value according to actual needs and tap "v" to successfully set the parameter.

#### 9.2.9.3.1 Set the grid-connected power limit parameters (general)

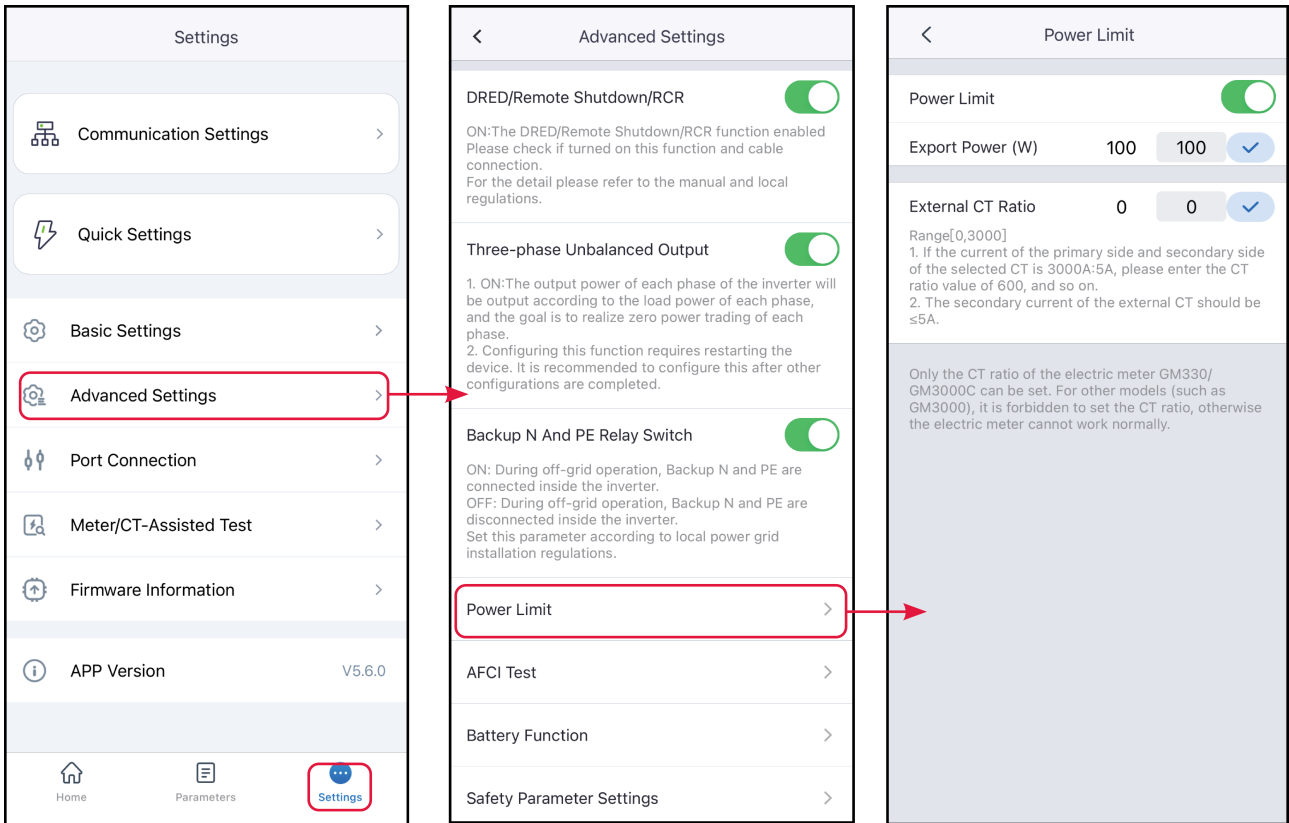

No.	Parameters	Description
1	Power Limit	Turn on this function when output power needs to be limited according to the grid standards of some countries or regions.
2	Export Power	Set according to the maximum power that can be input to the grid.
3	External Meter CT ratio	Set the ratio of the primary current to the secondary current of the external CT.

### 9.2.9.3.2 Setting the Power Limit Parameters (Australia)

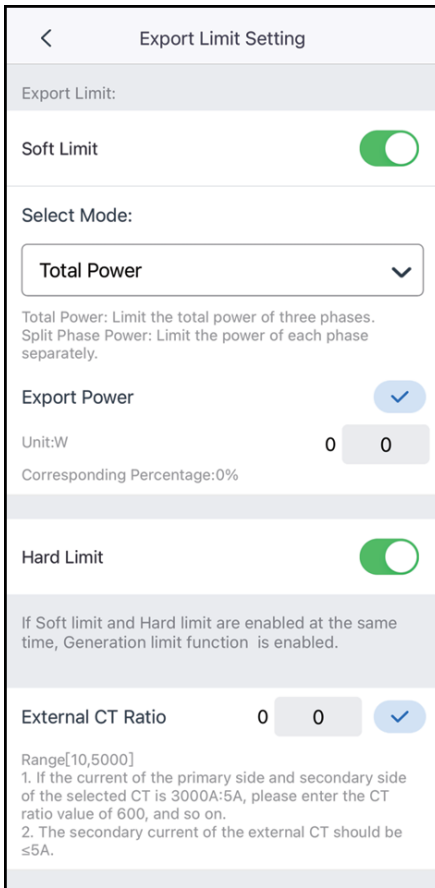

SLG00CON0133

No.	Parameters	Description
1	Software Power Limit	When output power needs to be limited according to grid standards in some countries or regions, turn on this function.
2	Limit Setting	<ul style="list-style-type: none"> <li>• Set according to the maximum power that can be actually input to the grid.</li> <li>• Supports setting of fixed power value or percentage. The set percentage is the percentage of the limit power to the rated power of the inverter.</li> <li>• After setting the fixed value, the percentage changes automatically; after setting the percentage, the fixed value changes automatically.</li> </ul>

No.	Parameters	Description
3	Hardware Power Limit	After enabling this function, when the amount of electricity fed into the grid exceeds the limit value, the inverter will automatically disconnect from the grid.
4	External Meter CT Ratio	Set the ratio of the primary current to the secondary current of the external CT.

### 9.2.9.4 Setting the AFCI Detection

**Step 1 :** Tap Home > Settings > Advanced Settings > AFCI Test to set the parameters.

**Step 2 :** Enable AFCI Test, Clear AFCI Alarm and Self-Check based on actual needs.

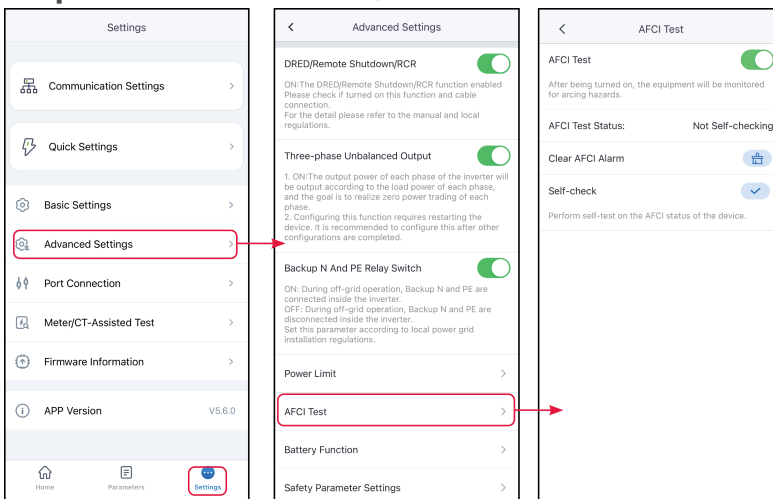

No.	Parameters	Description
1	AFCI Test	Enable or disable AFCI accordingly.
2	AFCI Test Status	The detection status like Not Self-checking.
3	Clear AFCI Alarm	Clear ARC Faulty alarm records.
4	Self-check	Tap to check whether the AFCI function works normally.

### 9.2.9.5 Setting the Battery

### 9.2.9.5.1 Set Parameters for Lithium Battery

**Step 1:** Tap **Home > Settings> Advanced Settings > Battery Function Settings** to set the parameters.

**Step 2:** Set the parameters based on actual needs.

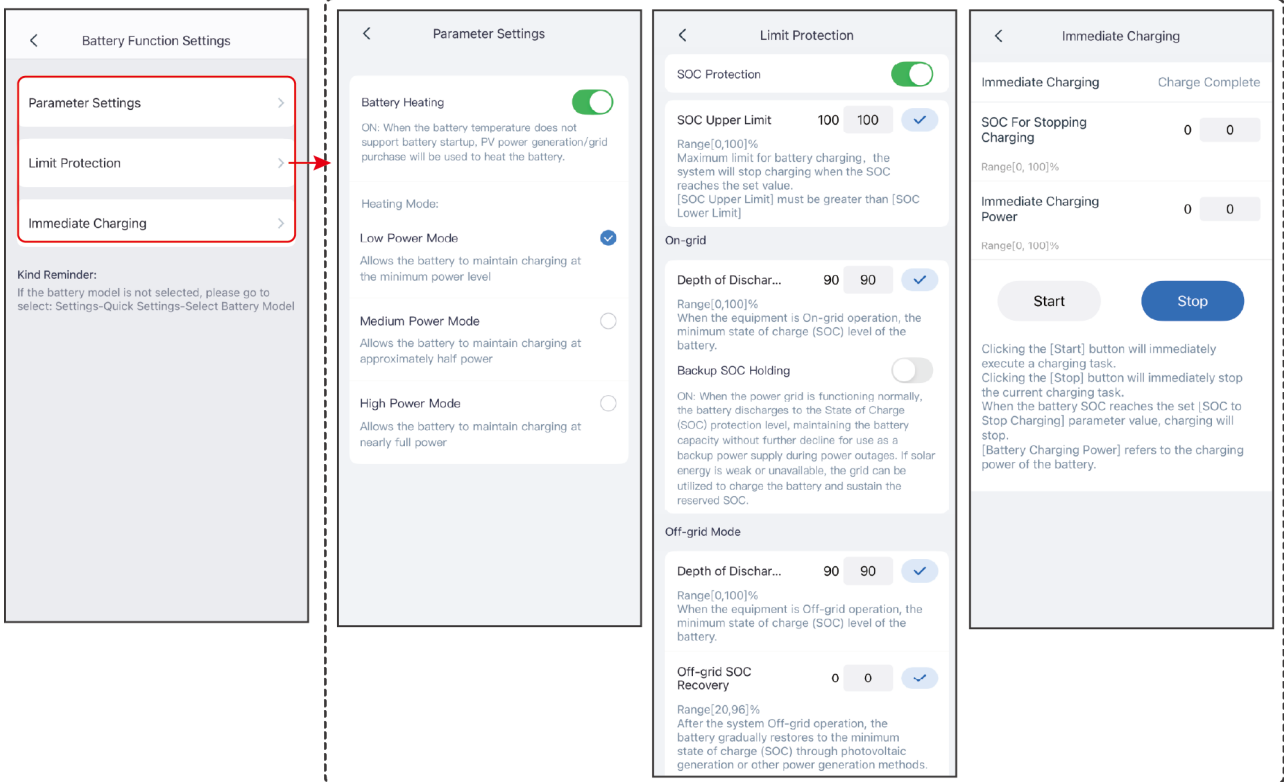

SLG00CON0072

No.	Parameter	Description
Parameter Settings		
1	Max. Charging Current	Only applicable to certain models. Set the maximum charging current based on actual needs.
2	Max. Discharging Current	Only applicable to certain models. Set the maximum discharging current based on actual needs.

No.	Parameter	Description
3	Battery Heating	<p>Optional. This option is displayed on the interface when a battery that supports heating is connected. After the battery heating function is turned on, when the temperature is below the value that starts up the battery, PV power or electricity from the grid will be used to heat the battery.</p> <p>Heating Mode:</p> <ul style="list-style-type: none"> <li>• GW5.1-BAT-D-G20/GW8.3-BAT-D-G20 <ul style="list-style-type: none"> <li>◦ Low Power Mode: Maintains minimum battery power input capacity, turns on when the temperature is below -9°C, and turns off when the temperature is above or equal to -7°C.</li> <li>◦ Medium Power Mode: to maintain the moderate power input capacity of the battery. It will be turned on when the temperature is less than 6°C, and turned off when it is greater than or equal to 8°C.</li> <li>◦ High Power Mode: to maintain the higher power input capacity of the battery. It will be turned on when the temperature is less than 11°C, and turned off when it is greater than or equal to 13°C.</li> </ul> </li> <li>• GW14.3-BAT-LV-G10 <ul style="list-style-type: none"> <li>◦ Low Power Mode: Maintains minimum battery power input capacity, turns on when the temperature is below 5°C, and turns off when the temperature is above or equal to 7°C.</li> <li>◦ Medium Power Mode: to maintain the moderate power input capacity of the battery. It will be turned on when the temperature is less than 10°C, and turned off when it is greater than or equal to 12°C.</li> <li>◦ High Power Mode: to maintain the higher power input capacity of the battery. It will be turned on when the temperature is less than 20°C, and turned off when it is greater than or equal to 22°C.</li> </ul> </li> </ul>

No.	Parameter	Description
4	Battery Wake-up	<ul style="list-style-type: none"> <li>• After being turned on, the battery can be awakened when it shuts down due to undervoltage protection.</li> <li>• Only applicable to lithium batteries without circuit breakers. After being turned on, the output voltage of the battery port is about 60V.</li> </ul>
Limit Protection		
5	SOC Protection	Start battery protection when the battery capacity is lower than the Depth of Discharge.
6	SOC Limit	The upper limit value for battery charging. Charging stops when the battery SOC reaches the SOC upper limit.
7	Discharge Depth (On-grid)	The maximum discharge value allowed for the battery when the inverter is in the on-grid scenario.
8	Backup Power SOC Maintenance	To ensure that the battery SOC is sufficient to maintain normal operation when the system is off-grid, the battery will purchase electricity from the grid and charge to the set SOC protection value when the system is connected to the grid.
9	Discharge Depth (Off-grid)	The maximum discharge value allowed for the battery when the inverter is in the off-grid scenario.
10	Off-grid SOC Recovery	When the inverter is operating off-grid, if the battery SOC drops below the lower limit, the inverter stops outputting power and only charges the battery until the battery SOC returns to the off-grid recovery SOC value. If the SOC lower limit value is higher than the off-grid recovery SOC value, charge to SOC lower limit +10%.
Immediate Charging		
11	Immediate Charging	Enable to charge the battery by the grid immediately. This takes effect once. Enable or Disable based on actual needs.

No.	Parameter	Description
12	SOC for Stopping Charging	Stop charging the battery once the battery SOC reaches SOC For Stopping Charging.
13	Immediate Charging Power	Indicates the percentage of the charging power to the inverter rated power when enabling Immediate Charging. For example, for an inverter with a rated power of 10kW, when set to 60, the charging power is 6kW.
14	Start	Start charging immediately.
15	Stop	Immediately stop the current charging task.

#### 9.2.9.6 Setting PV Connect Mode

Select the PV connect mode based on the actual connections between the PV strings and MPPT ports of the inverter.

**Step 1** : Tap **Home > Settings > Advanced Settings > PV Connect Mode** to set the parameters.

**Step 2** : Set the connect mode to Independent Access, Partial Parallel Connect or Parallel Connection based on actual connections.

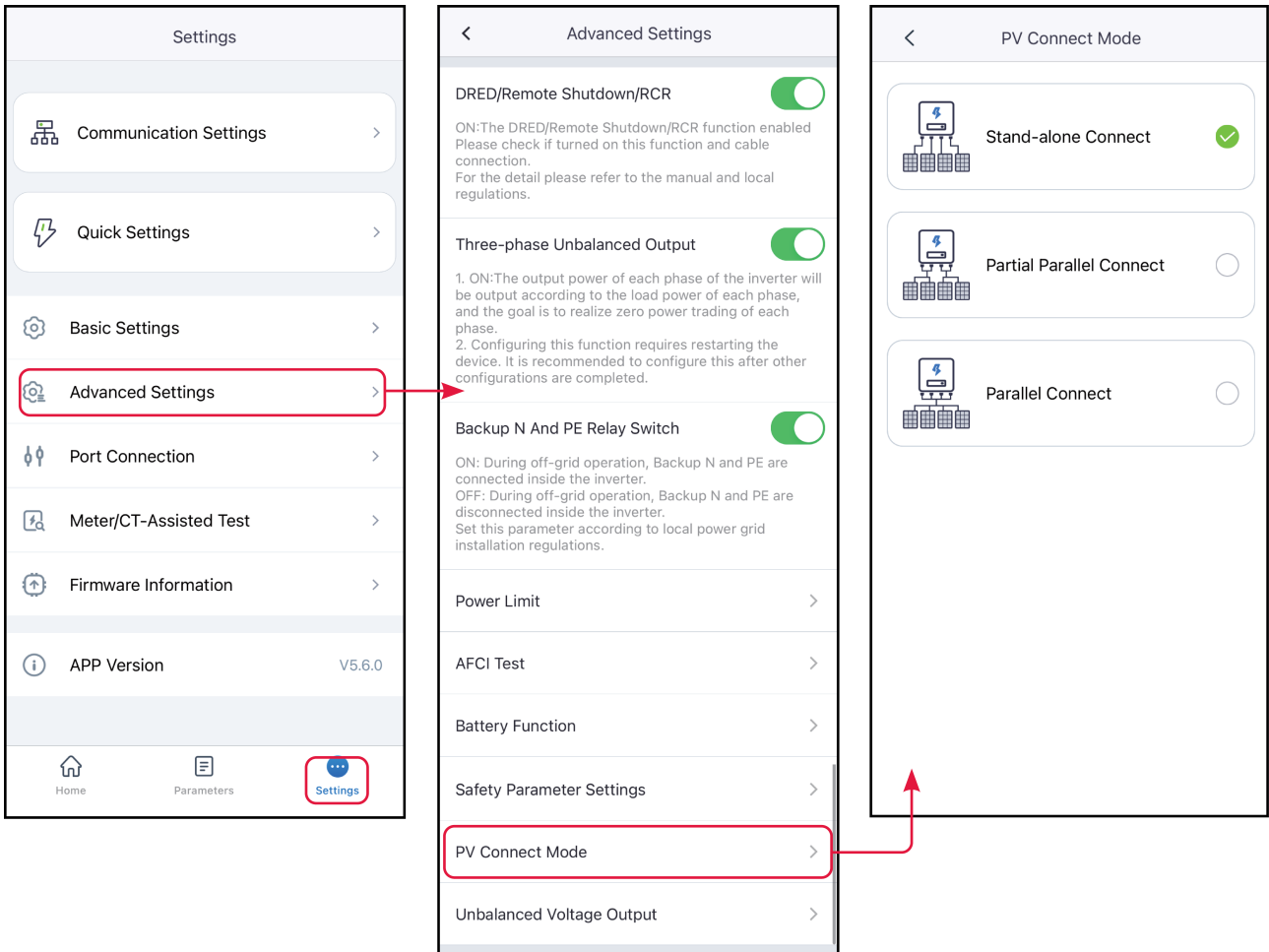

No.	Parameters	Description
1	Stand-alone Connect	The external PV string is connected to multi MPPT terminals of the inverter.
2	Partial Parallel Connect	The PV strings are connected to the inverter in both stand-alone and parallel connection. For example, one PV string connect to MPPT1 ad MPPT2, another PV string connect to MPPT3.
3	Parallel Connect	When an external PV string is connected to the PV input port on the inverter side, one PV string is connected to multiple PV input ports.

## 9.2.10 Setting Safety Parameters

## NOTICE

Set the custom safety parameters in compliance with local requirements. Do not change the parameters without the prior consent of the grid company.

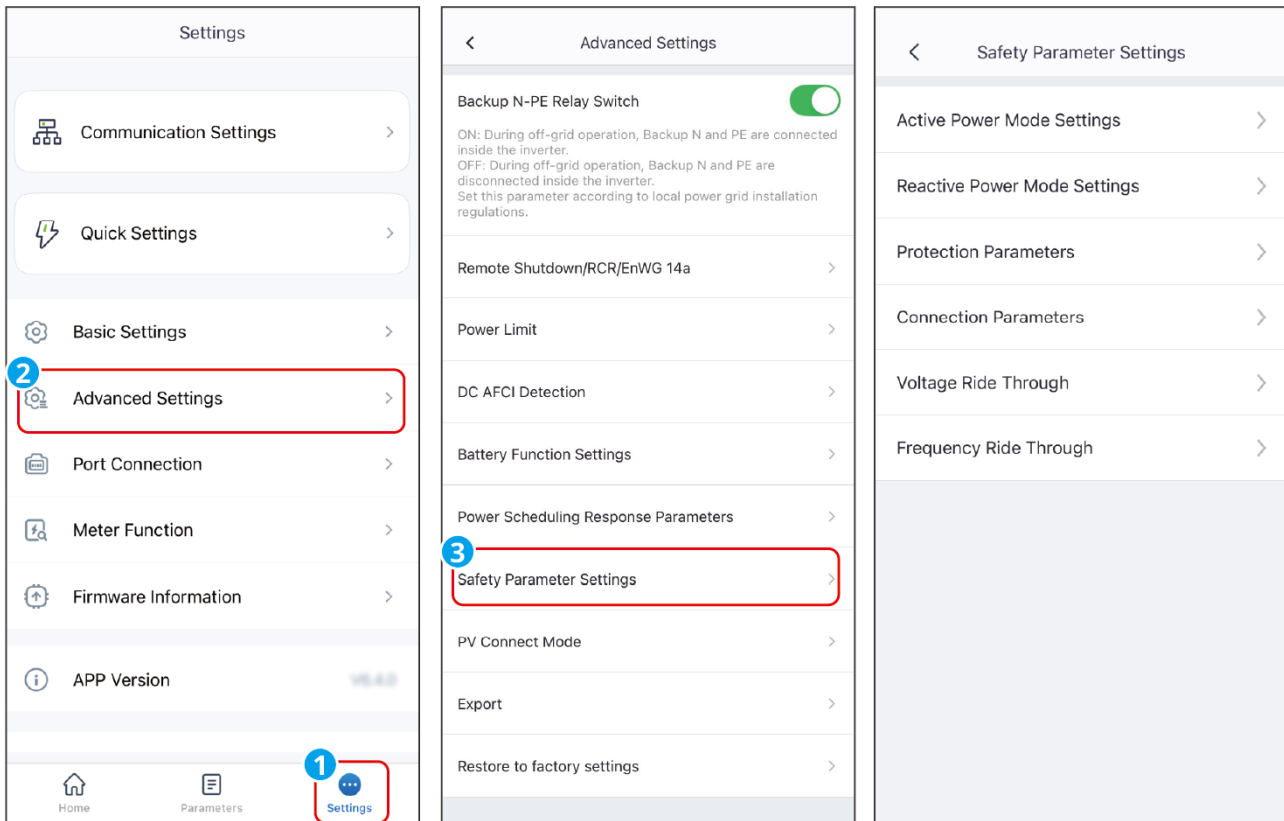

SLG00CON0076

### 9.2.10.1 Setting the Reactive Power Mode

**Step 1 :** Tap **Home > Settings > Advanced Settings > Safety Parameter Setting > Reactive Power Mode Settings** to set the parameters.

**Step 2 :** Set the parameters based on actual needs.

**Q(U) Curve**

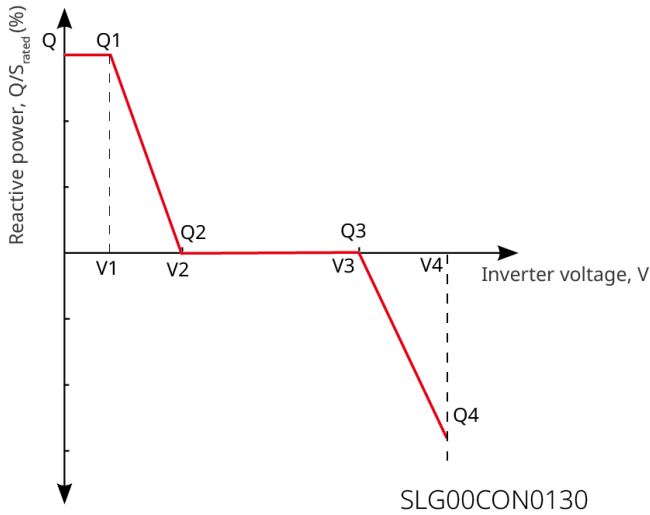

### Cosφ Curve

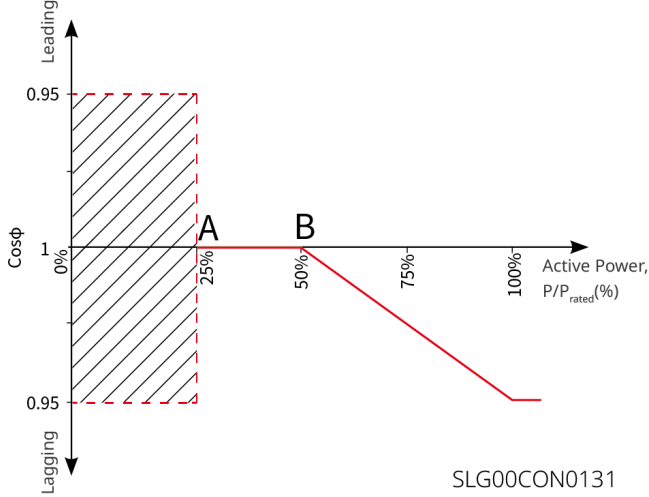

No.	Parameters	Description
Fix PF		
1	Fix PF	Enable Fix PF when it is required by local grid standards and requirements. After the parameters are set successfully, the power factor remains unchanged during the operation of the inverter.
2	Under-excited	Set the power factor as lagging or leading based on actual needs and local grid standards and requirements.
3	Over-excited	
4	Power Factor	Set the power factor based on actual needs. Range: 0~-0.8, or +0.8~+1.
Fix Q		

No.	Parameters	Description
1	Fix Q	Enable Fix Q when it is required by local grid standards and requirements.
2	Over-excited/Under-excited	Set the reactive power as inductive or capacitive reactive power based on actual needs and local grid standards and requirements.
3	Reactive Power	Set the ratio of reactive power to apparent power.
Q(U) Curve		
1	Q(U) Curve	Enable Q(U) Curve when it is required by local grid standards and requirements.
2	Mode Selection	Set Q(U) curve mode, supporting basic mode and slope mode.
3	Vn Voltage	The percentage of actual voltage to the rated voltage at Vn point, n=1, 2, 3, 4. When set to 90, it means: $V/V_{rated}\% = 90\%$ .
4	Vn Reactive Power	The percentage of the reactive output power to the apparent power at Vn point, n=1, 2, 3, 4. For example, setting <b>Vn Reactive Power</b> to 48.5 means $Q/S_{rated}\%=48.5\%$ .
5	Voltage Deadband Width	When Q(U) curve mode is set to slope mode, this parameter defines the voltage deadband range where no reactive power output is required.
6	Over-excitation Slope	(In Q(U) slope mode) Sets the positive or negative slope for reactive power variation during over-voltage conditions.
7	Under-excitation Slope	
8	Vn Reactive Power	The percentage of the reactive output power to the apparent power at Vn point, n=1, 2, 3, 4. For example, setting <b>Vn Reactive Power</b> to 48.5 means $Q/S_{rated}\%=48.5\%$ .

No.	Parameters	Description
9	Q(U) Curve Response Time Constant	The reactive power must reach 95% of the target value within 3 time constants, following a first-order low-pass filter curve.
10	Extended Function	Enable the extended function and configure the corresponding parameters.
11	Lock-In Power	When the inverter output reactive power to the rated power ratio is between the Lock-in power and Lock-out power, the ratio meets Q(U) curve requirements.
12	Lock-out Power	
Cosφ(P) Curve		
1	Cosφ(P) Curve	Enable Cosφ Curve when it is required by local grid standards and requirements.
2	Mode Selection	Set cosφ(P) Curve Mode and support basic mode and slope mode configurations.
3	N-point Power	The percentage of inverter output active power relative to rated power at the N-point. N=A, B, C, D, E.
4	N-point cosφ Value	N-point Power Factor N=A, B, C, D, E.
5	Over-excitation Slope	When cosφ(P) curve mode is set to slope mode, configures the power variation slope as either positive or negative.
6	Under-excitation Slope	
7	N-point Power	The percentage of inverter output active power relative to rated power at the N-point. N=A, B, C.
8	N-point cosφ Value	N-point Power Factor N=A, B, C.
9	cosφ(P) Curve Response Time Constant	The reactive power must reach 95% of the target value within 3 time constants, following a first-order low-pass filter curve.
10	Extended Function	Enable the extended function and configure the corresponding parameters.

No.	Parameters	Description
11	Lock-in Voltage	When the grid voltage is between Lock-in Voltage and Lock-out Voltage, the voltage meets Cosφ curve requirements.
12	Lock-out Voltage	
Q(P) Curve		
1	Q(P) Curve Function	Enable Q(P) Curve when it is required by local grid standards and requirements.
2	Mode Selection	Set Q(P) curve mode, supporting basic mode and slope mode.
3	Pn-point Power	The percentage of the output reactive power to the rated power at Pn point, n=1, 2, 3, 4, 5, 6. For example, setting to 90 means $Q/P_{rated}\%=90\%$ .
4	Pn-point Reactive Power	The percentage of the output active power to the rated power at Pn point, n=1, 2, 3, 4, 5, 6. For example, When set to 90, it means: $P/P_{rated}\% = 90\%$ .
5	Over-excitation Slope	When the Q(P) curve mode is set to slope mode, configure the power variation slope as either a positive or negative value.
6	Under-excitation Slope	
7	Pn-point Power	Ratio of reactive power to rated power at Pn points (n=1, 2, 3). For example, setting to 90 means $Q/P_{rated}\%=90\%$ .
8	Pn-point Reactive Power	Ratio of active power to rated power at Pn points (n=1, 2, 3). For example, When set to 90, it means: $P/P_{rated}\% = 90\%$ .
9	Time Constant	The reactive power must reach 95% of the target value within 3 time constants, following a first-order low-pass filter curve.

## 9.2.10.2 Setting the Active Power Mode

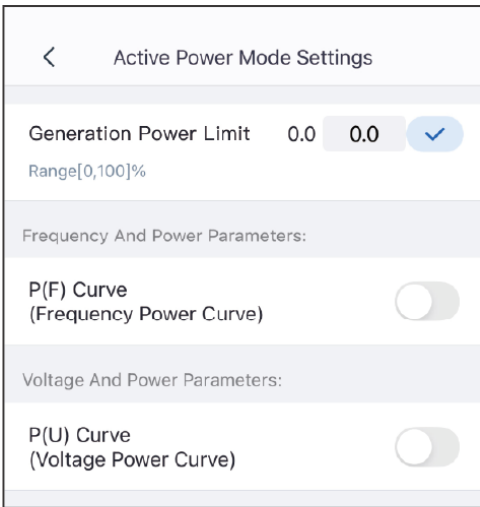

SLG00CON0149

**Step 1:** Tap **Home > Settings > Advanced Settings > Safety Parameter Settings > Active Power Mode Settings** to set the parameters.

**Step 2:** Set the parameters based on actual needs.

### P(F) Curve

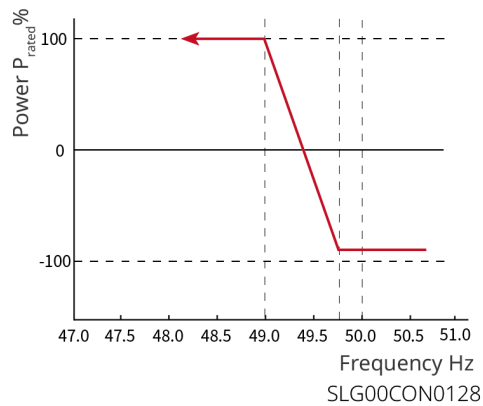
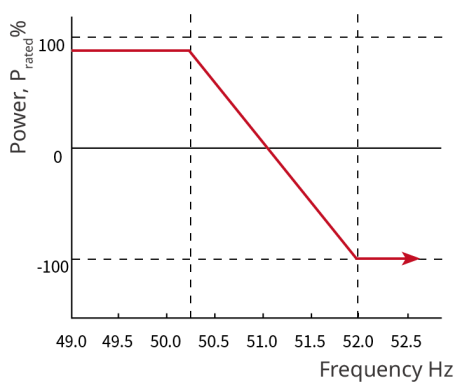

SLG00CON0128

### P(U) Curve

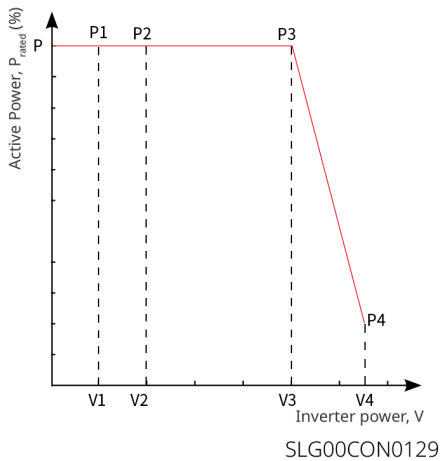

No.	Parameter s	Explanation
1	Generation Power Limit	Set the change slope when the active output power increases or decreases.
2	Power Gradient	Set the active power change slope.
<b>Overfrequency Unloading</b>		
1	P(F) Curve	Enable P(F) Curve when it is required by local grid standards and requirements.
2	Over-Frequency Load Shedding Mode	Set the overfrequency unloading mode based on actual needs. <ul style="list-style-type: none"> <li>• Slope mode: adjusts power based on the over frequency point and load reduction slope.</li> <li>• Stop mode: adjusts the power based on the over-frequency start point and over-frequency end point.</li> </ul>
3	Overfrequency Threshold	The inverter output active power will decrease when the utility grid frequency is too high. The inverter output power will decrease when the utility grid frequency is higher than <b>Overfrequency Threshold</b> .

No.	Parameters	Explanation
4	Import/Export Electricity Conversion Frequency	When the set frequency value is reached, the system switches from selling electricity to buying electricity.
5	Overfrequency Endpoint	The inverter output active power will decrease when the utility grid frequency is too high. The inverter output power will stop decreasing when the utility grid frequency is higher than <b>Overfrequency Endpoint</b> .
6	Over-Frequency Power Slope Reference Power	Adjust the inverter output power based on Apparent Active Power, Rated Active Power, Momentary Active Power, Or Max. Active Power.
7	Power response to overfrequency gradient	The inverter output active power will increase when the utility grid frequency is too high. Indicates the slope when the inverter output power decreases.
8	Intentional Delay $T_a$	Indicates the delayed response time when the inverter output power is higher than the <b>Overfrequency Threshold</b> .
9	Hysteretic Function	Enable the hysteretic function.
10	Frequency Hysteresis Point	During over-frequency load reduction, if the frequency decreases, the power output is based on the lowest point of the load reduction power until the frequency is less than the hysteresis point and the power is restored.
11	Hysteresis Waiting Time	For over-frequency load reduction and frequency decrease, when the frequency is less than the hysteresis point, the power recovery waiting time, that is, it takes a certain amount of time to recover the power.

No.	Parameters	Explanation
12	Hysteresis Power Recovery Slope Reference Power	For over-frequency load reduction and frequency decrease, when the frequency is less than the hysteresis point, the power recovery benchmark, that is, the power recovery is based on the recovery slope * the rate of change of the reference power. Support: P <sub>n</sub> rated power, P <sub>s</sub> apparent power, P <sub>m</sub> current power, P <sub>max</sub> maximum power, power difference ( $\Delta P$ ).
13	Hysteretic Power Recovery Slope	For over-frequency load reduction and frequency reduction, when the frequency is less than the hysteresis point, the power change slope when the power is restored.
Underfrequency Loading		
1	P(F) Curve	Enable P(F) Curve when it is required by local grid standards and requirements.
2	Underfrequency Load Mode	Set the underfrequency unloading mode based on actual needs. <ul style="list-style-type: none"> <li>• Slope mode: adjusts power based on the underfrequency point and load increase slope.</li> <li>• Stop mode: adjusts the power based on the underfrequency start point and underfrequency end point.</li> </ul>
3	Underfrequency Threshold	The inverter output active power will increase when the utility grid frequency is too low. The inverter output power will increase when the utility grid frequency is lower than <b>Underfrequency Threshold</b> .
4	Import/Export Electricity Conversion Frequency	When the set frequency value is reached, the system switches from selling electricity to buying electricity.

No.	Parameters	Explanation
5	Underfrequency Endpoint	The inverter output active power will increase when the utility grid frequency is too low. The inverter output power will stop increasing when the utility grid frequency is lower than <b>Underfrequency Endpoint</b> .
6	Over-Frequency Power Slope Reference Power	Adjust the inverter output power based on Apparent Active Power, Rated Active Power, Momentary Active Power, Or Max. Active Power.
7	Under-Frequency Power Slope	The inverter output active power will increase when the utility grid frequency is too low. The slope of the inverter output power when it rises.
8	Tentential Delay Ta	Indicates the delayed response time when the inverter output power is lower than the <b>Underfrequency Threshold</b> .
9	Hysteretic Function	Enable the hysteretic function.
10	Frequency Hysteresis Point	During underfrequency loading, if the frequency increases, the power is output according to the lowest point of the loaded power until the frequency is higher than the hysteresis point and the power is restored.
11	Hysteresis Waiting Time	For underfrequency loading, the frequency increases, when the frequency is higher than the hysteresis point, the waiting time for power recovery, that is, it takes a certain amount of time to recover the power.

No.	Parameters	Explanation
12	Hysteresis Power Recovery Slope Reference Power	For underfrequency loading, the frequency increases, when the frequency is higher than the hysteresis point, the benchmark for power recovery, that is, the power recovery is carried out according to the recovery slope * the rate of change of the benchmark power. Support: P <sub>n</sub> rated power, P <sub>s</sub> apparent power, P <sub>m</sub> current power, P <sub>max</sub> maximum power, power difference ( $\Delta P$ ).
13	Hysteretic Power Recovery Slope	For under-frequency loading, frequency increase, when the frequency is higher than the hysteresis point, the power change slope when power is restored.
14	P(U) Curve	Enable P(U) Curve when it is required by local grid standards and requirements.
15	V <sub>n</sub> Voltage	The percentage of actual voltage to the rated voltage at V <sub>n</sub> point, n= 1, 2, 3, 4. For example, setting V <sub>n</sub> Voltage to 90 means V/V <sub>rated</sub> %=90%.
16	V <sub>n</sub> Active Power	The percentage of the output active power to the apparent power at V <sub>n</sub> point, (n= 1, 2, 3, 4). For example, setting <b>V<sub>n</sub> Reactive Power</b> to 48.5 means P/P <sub>rated</sub> %=48.5%.
17	Output Response Mode	Set the active power output response mode. Supports: <ul style="list-style-type: none"> <li>• PT-1 Behavior, realize active scheduling based on the first-order LPF curve within the response time constant.</li> <li>• Gradient Control, realize active scheduling based on the power change slope.</li> </ul>
18	Power Gradient	When the output response mode is set to Gradient Control, active power scheduling is achieved according to the power change gradient.

No.	Parameters	Explanation
19	First-order Low-pass Filter Time Parameter	Set the time constant within which the active power changes based on the first order LPF curve when the Output Response Mode is set to be First-order Low-pass Filter Time Parameter.
20	Overload Function Switch	When enabled, the maximum active power output is 1.1 times the rated power; otherwise, the maximum active power output is consistent with the rated power value.

### 9.2.10.3 Setting Protection Parameters

**Step 1 :** Tap **Home > Settings > Advanced Settings > Safety Parameter Settings > Protection Parameters** to set the parameters.

**Step 2:** Set the parameters based on actual needs.

No.	Parameters	Description
1	OV Stage n Trip Value	Set the grid overvoltage protection threshold value, n=1,2,3,4.
2	OV Stage n Trip Time	Set the grid overvoltage protection tripping time, n=1,2,3,4.
3	UV Stage n Trip Value	Set the grid undervoltage protection threshold value, n=1,2,3,4.
4	UV Stage n Trip Time	Set the grid undervoltage protection tripping time.
5	10min Overvoltage Trip Threshold	Set the 10min overvoltage protection threshold value.
6	10min Overvoltage Trip Time	Set the 10min overvoltage protection tripping time.
7	OF Stage n Trip Value	Set the grid overfrequency triggering n-th order protection point, n=1,2,3,4.
8	OF Stage n Trip Time	Set the grid overfrequency trigger n-th order trip time, n=1,2,3,4.

No.	Parameters	Description
9	UF Stage n Trip Value	Set the grid underfrequency triggering n-th order protection point, n=1,2,3,4.
10	UF Stage n Trip Time	Set the grid underfrequency trigger n-th order trip time, n=1,2,3,4.

### 9.2.10.4 Setting Connection Parameters

**Step 1 :** Tap **Home > Settings > Advanced Settings > Safety Parameter Settings > Protection Parameters** to set the parameters.

**Step 2:** Set the parameters based on actual needs.

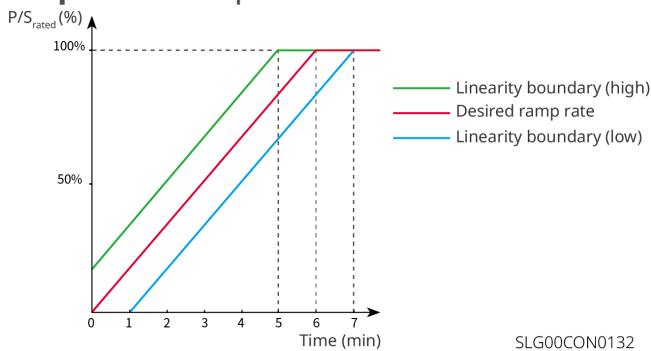

No.	Parameters	Description
Ramp Up		
1	Upper Voltage	The inverter cannot connect to the grid if it is powered on for the first connection and the grid voltage is higher than the <b>Upper Voltage</b> .
2	Lower Voltage	The inverter cannot connect to the grid if it is powered on for the first connection and the grid voltage is lower than the <b>Lower Voltage</b> .
3	Upper Frequency	The inverter cannot connect to the grid if it is powered on for the first connection and the grid frequency is higher than the <b>Upper Frequency</b> .

No.	Parameters	Description
4	Lower Frequency	The inverter cannot connect to the grid if it is powered on for the first connection and the grid frequency is lower than the <b>Lower Frequency</b> .
5	Observation Time	The waiting time for connecting the inverter to the grid when meeting the following requirements. 1. The inverter is powered on for the first connection. 2. The utility grid voltage and frequency meet certain requirements.
6	Soft Ramp Up Gradient	Enable the start up power slope.
7	Soft Ramp Up Gradient	Indicates the percentage of incremental output power per minute based on the local requirements when the inverter is powered on for the first time.
Reconnection		
8	Upper Voltage	The inverter cannot connect to the grid if it is reconnecting due to a fault and the grid voltage is higher than the <b>Upper Voltage</b> .
9	Lower Voltage	The inverter cannot connect to the grid if it is reconnecting due to a fault and the grid voltage is lower than the <b>Lower Voltage</b> .
10	Upper Frequency	The inverter cannot connect to the grid if it is reconnecting due to a fault and the grid frequency is higher than the <b>Upper Frequency</b> .
11	Lower Frequency	The inverter cannot connect to the grid if it is reconnecting due to a fault and the grid frequency is lower than the <b>Lower Frequency</b> .
12	Observation Time	The waiting time for connecting the inverter to the grid when meeting the following requirements. 1. The inverter is reconnecting to the grid due to a fault. 2. The utility grid voltage and frequency meet certain requirements.
13	Reconnection Gradient	Enable the start up power slope.

No.	Parameters	Description
14	Reconnection Gradient	Indicates the percentage of incremental output power per minute based on the local requirements when the inverter is powered on for the first time. For example, setting Reconnection Gradient to 10 means the reconnect slope is 10%P/Srated/min.

### 9.2.10.5 Setting Voltage Ride Through Parameters

**Step 1 :** Tap **Home > Settings > Advanced Settings > Safety Parameter Settings > Voltage Ride Through** to set the parameters.

**Step 2 :** Set the parameters based on actual needs.

No.	Parameters	Description
LVRT		
1	UVn Voltage	The ratio of the ride through voltage to the rated voltage at UVn point during LVRT. n=1,2,3,4,5,6,7.
2	UVn Time	The ride through time at UVn point during LVRT. n=1,2,3,4,5,6,7
3	Enter Into LVRT Threshold	The inverter will not be disconnected from the utility grid immediately when the grid voltage is between Enter Into LVRT Threshold and Exit LVRT Endpoint.
4	Exit LVRT Endpoint	
5	Slope K2	K-factor for reactive power during LVRT.
6	Zero Current Mode	The system outputs zero current during LVRT.
7	Entry Threshold	Set the entry threshold of zero current mode.
HVRT		

No.	Parameters	Description
1	OVn Voltage	The ratio of the ride through voltage to the rated voltage at OVn point during HVRT. n=1,2,3,4,5,6,7.
2	OVn Time	The ride through time at OVn point during HVRT. n=1,2,3,4,5,6,7.
3	Enter High Crossing Threshold	The inverter will not be disconnected from the utility grid immediately when the grid voltage is between Enter High Crossing Threshold and Exit High Crossing Threshold.
4	Exit High Crossing Threshold	
5	Slope K2	K-factor for reactive power during HVRT.
6	Zero Current Mode	The system outputs zero current during HVRT.
7	Entry Threshold	Set the entry threshold of zero current mode.

### 9.2.10.6 Setting Frequency Ride Through Parameters

**Step 1 :** Tap **Home > Settings > Advanced Settings > Safety Parameter Settings > Frequency Ride Through** to set the parameters.

**Step 2 :** Set the parameters based on actual needs.

No.	Parameters	Description
1	UFn Frequency	The frequency at the UFn point during frequency ride through.
2	UFn Frequency	The frequency at the UFn point during frequency ride through. n=1,2,3.
3	UFn Time	The ride through duration at the UFn point during frequency ride through. n=1,2,3.

No.	Parameters	Description
4	OFn Frequency	The frequency at the OFn point during frequency ride through. n=1,2,3。
5	OFn Time	The ride through duration at the OFn point during frequency ride through. n=1,2,3。

## 9.2.11 Exporting Parameters

### 9.2.11.1 Exporting Safety Parameters

After selecting the safety code, some models support exporting safety parameter files.

**Step 1 :** Tap **Home > Settings > Advanced Settings > Export** to export the parameters.

**Step 2 :** Select Safety Parameters, and tap **Export** to start downloading the current safety parameter file. When the export is complete, tap **Share** and choose how you want to open the exported file.

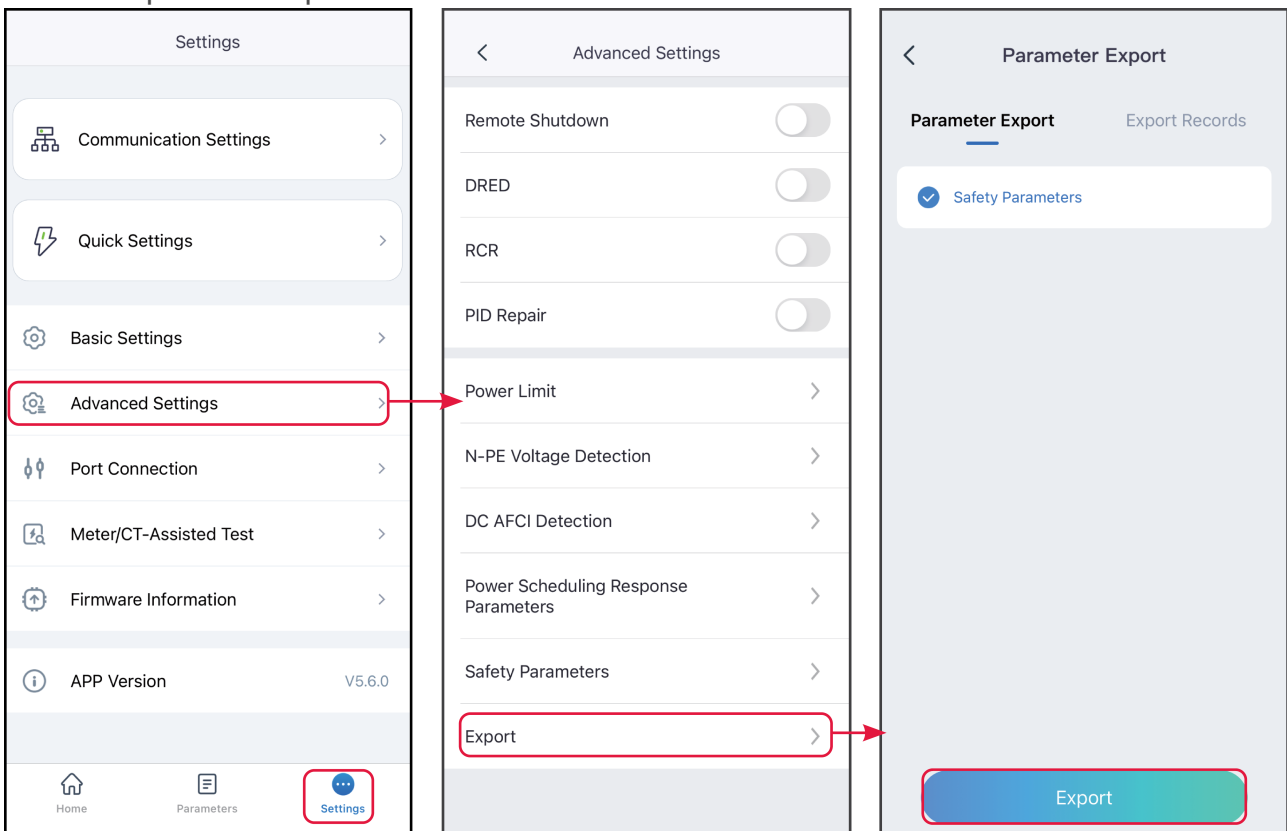

## 9.2.11.2 Exporting Log Parameters

**Step 1 :** Tap **Home > Settings > Advanced Settings > Export.**

**Step 2 :** Select the device type to export logs, such as inverter logs, communication module logs, etc.

**Step 3:** Select the log type to export, download and export the log file. After the export is complete, tap **Share** and choose how to open the exported file according to actual needs.

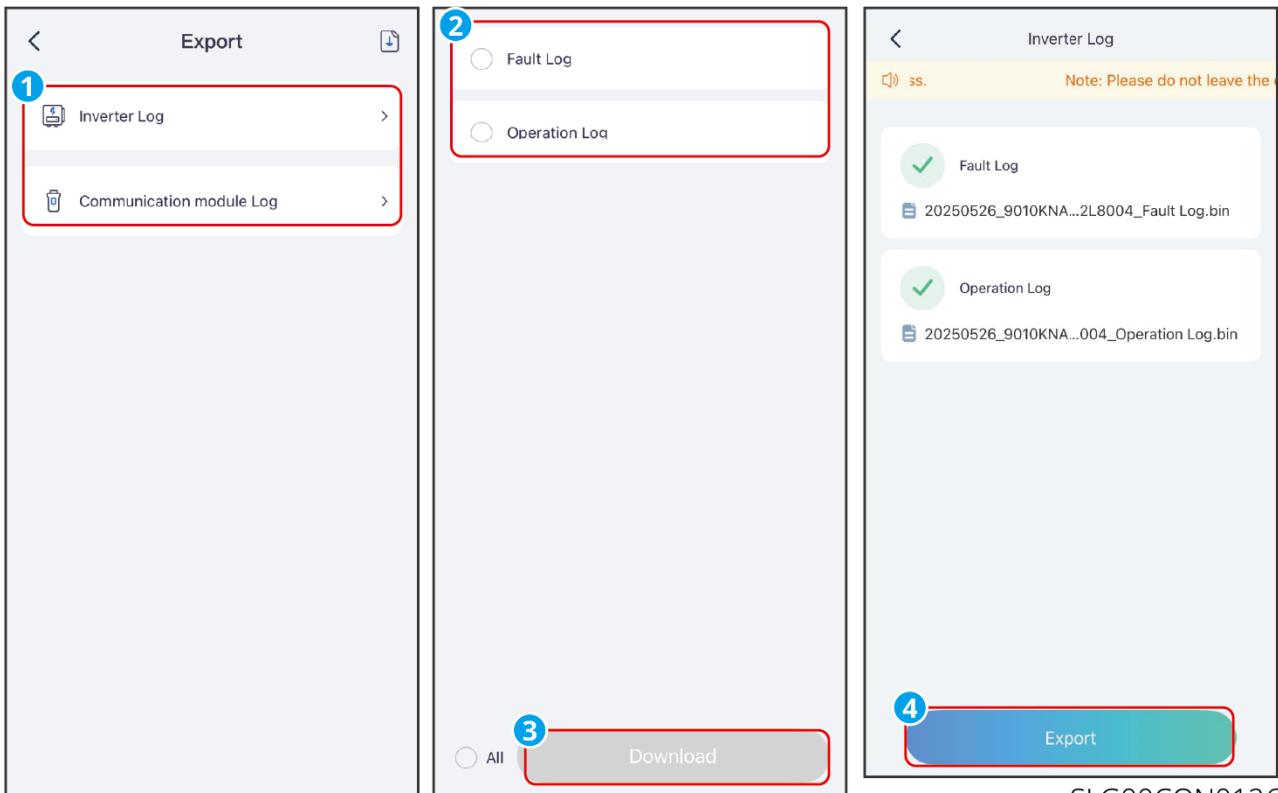

SLG00CON0126

## 9.2.12 Setting the Meter Parameters



### 9.2.12.1 Bind/Unbind Meter

## NOTICE

- When the PV system uses both the grid-connected inverter and the energy storage inverter to achieve coupling or microgrid functions, dual meters may be used in the system. Please set the meter binding information according to the actual usage.
- Applicable only to GoodWe meters.

**Step 1** : Tap **Home > Settings > Meter Function > Meter Binding** to enter the binding interface.

**Step 2** : Tap **Quantity/Location of Meters** to select the actual application scenario. Supported options: Meter 1 (built-in) No Meter 2; Meter 1 (external) No Meter 2; Meter 1 (built-in) Meter 2 (external); Meter 1 (external) Meter 2 (external). the interface of Meter 1 (built-in) Meter 2 (external) is used as an example to explain how to bind the meter.

**Step 3** : As shown in the figure below, when you choose to use an external meter, you need to manually add the external meter information. Tap  to bind the meter by manually entering the meter SN or scanning the meter SN QR code. When the bound meter model is GM330, please set the meter CT ratio according to the actual situation and click  to complete the setting. If you use other meters, you do not need to set the meter CT ratio.

**Step 4** : (Optional) If you need to unbind the external meter, please tap **Remove Binding**.

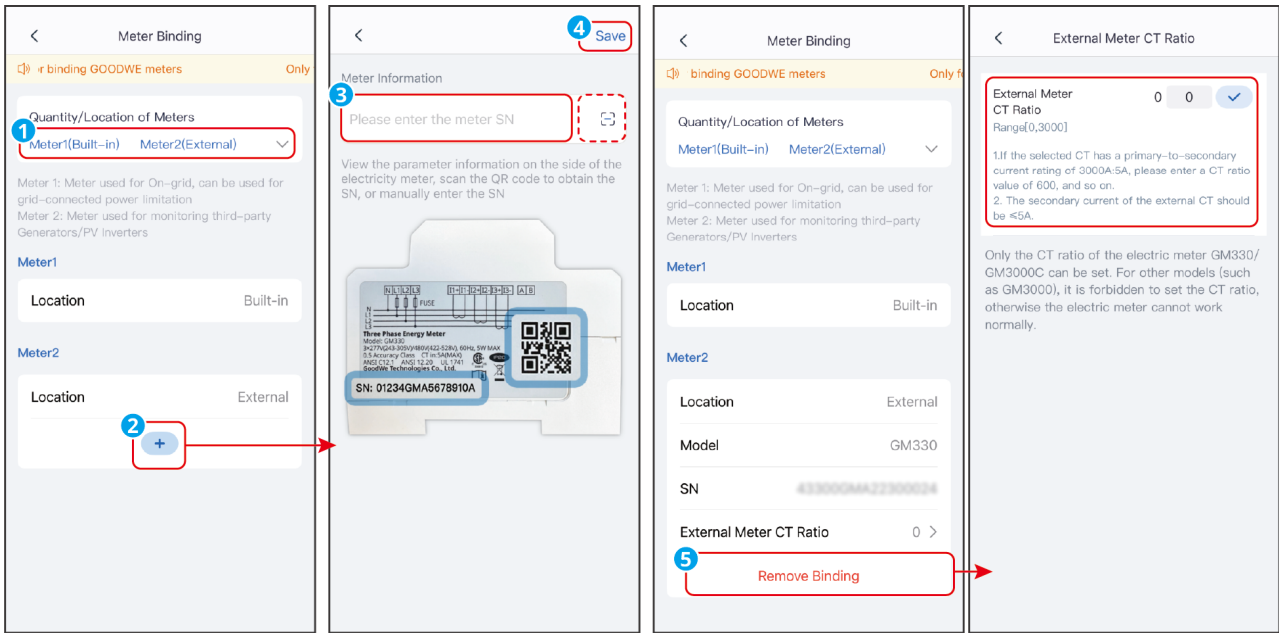

SLG00CON0123

### 9.2.12.2 Meter/CT-Assisted Test

Meter/CT-Assisted Test is used to auto-check if the Smart Meter and CT are connected in the right way and their working status.

**Step 1 :** Tap **Home > Settings > Meter/CT Assisted Test** to set the function.

**Step 2 :** Tap **Start Test** to start test. Check Test Result after test.

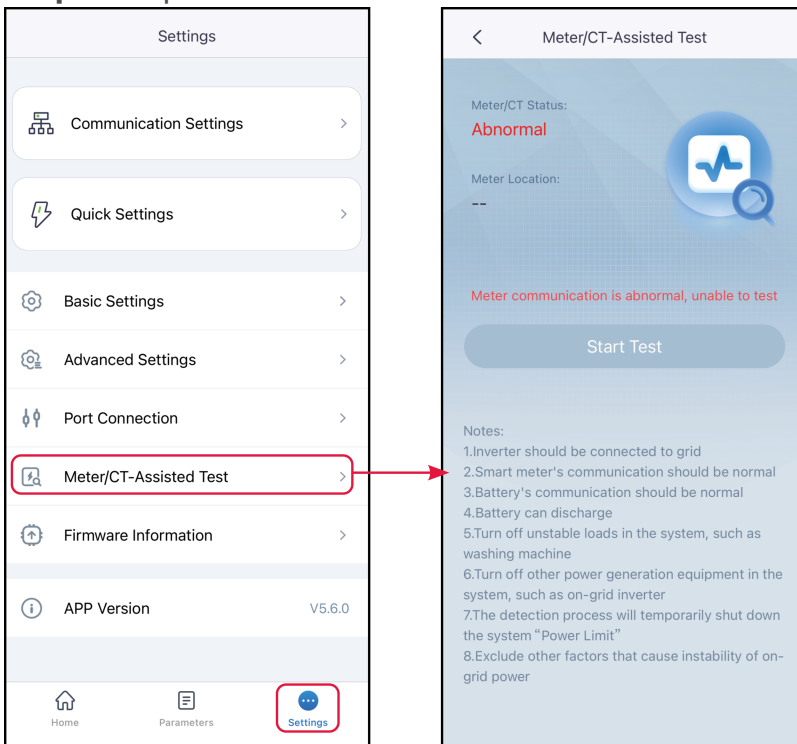

## 9.2.13 Setting Generator/Load Control

### 9.2.13.1 Setting Load Control

#### NOTICE

- Loads and generators can be controlled by SolarGo app when the inverter supports load control function.
- For ET40-50kW series inverters, the load control function is supported only when the inverter is used with STS. The inverter supports load control of the GENERATOR port or the BACKUP LOAD port.

**Step 1:** Tap **Home > Settings > Port Connection** to set the parameters.

**Step 2:** Select **Generator Control** or **Load Control** based on actual needs.

- **Dry Contact Mode:** when the switch is ON, the loads will be powered; when the switch is OFF, the power will be cut off. Turn on or off the switch based on actual needs.

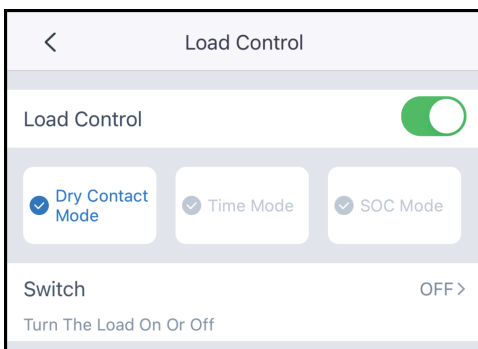

- **Time Mode:** set the time to enable the load, and the load will be powered automatically within the setting time period. Select standard mode or intelligent mode.

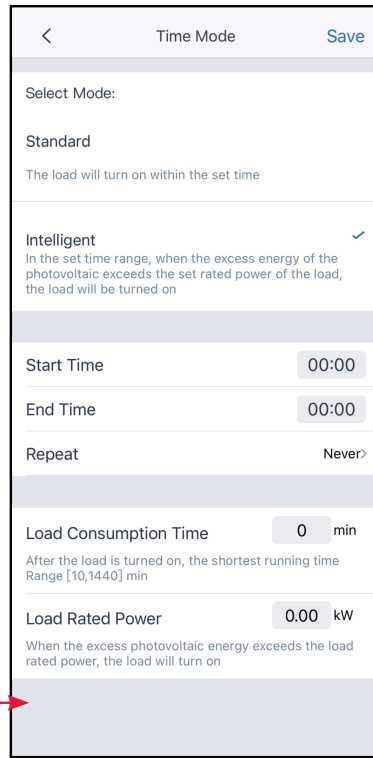
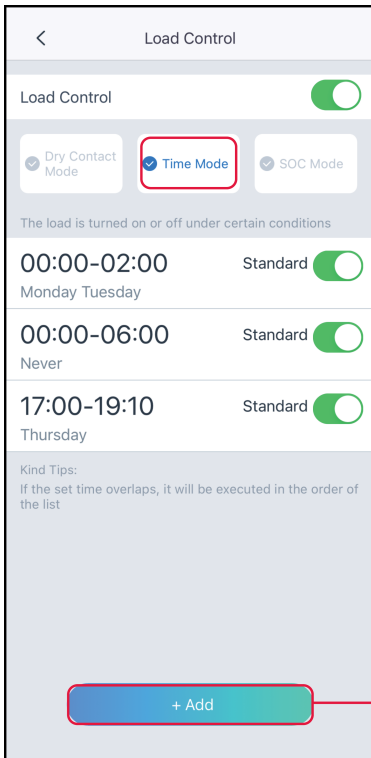

No.	Parameters	Description
1	Standard	The loads will be powered within the setting time period.
2	Intelligent	Once the excess energy of the photovoltaic exceeds the load nominal power within the time period, the loads will be powered.
3	Start Time	The time mode will be on between the Start Time and End Time.
4	End Time	
5	Repeat	The repeat days.
6	Load Consumption Time	The shortest load working time after the loads been powered. The time is set to prevent the loads be turned on and off frequently when the PV power fluctuates greatly. Only for Intelligent mode.
7	Load Rated Power	The loads will be powered when the excess energy of the photovoltaic exceeds the nominal power of load. Only for Intelligent mode.

- SOC Mode: the inverter has integrated dry contact controlling port, which can control whether the load is powered or not by contactor. In off-grid mode, the load connected to the port will not be powered if the BACKUP overload is detected or

the battery SOC value is lower than the Off-grid battery protection value. Set Off-grid Battery Protection Value based on actual needs.

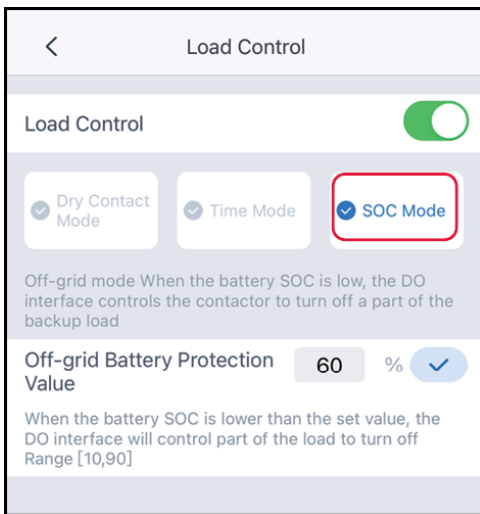

### 9.2.13.2 Setting the Generator Parameters

#### NOTICE

- When the inverter supports the generator control function, the generator can be controlled through the SolarGo App.
- For ET40-50kW series inverters, the generator can be connected and controlled only when the inverter is used with STS.

**Step 1 :** Tap **Home > Settings > Port Connection** to set the parameters.

**Step 2:** Select Generator Connection or Load Connection based on actual needs.

**Step 3 :** When setting the generator control function, select the generator type according to the actual access situation. Currently supported:**Not Installed, Manual Control Of Generator** or **Automatic Control Generator**. And set the parameters according to the selected generator type.

- Not Installed: If no generator is connected in the system, select Not Installed.
- Manual Control Of Generator(Doesn't Support Dry Node Connection): Start or stop the generator manually. The inverter cannot control the generator when Manual Control Of Generator(Doesn't Support Dry Node Connection) is selected.

- Automatic control generator (Supports dry node connection): If the generator has dry contact port and is connected to the inverter, set the generator control mode to Switch Control Mode or Automatic Control Mode based on actual needs.
  - Switch Control Mode: The generator will start working when the Generator Dry Node Switch is on, and stop automatically after reaching Run Time.
  - Automatic Control Mode: The generator will work during Run Time, but stop working during Prohibited Working Hours.

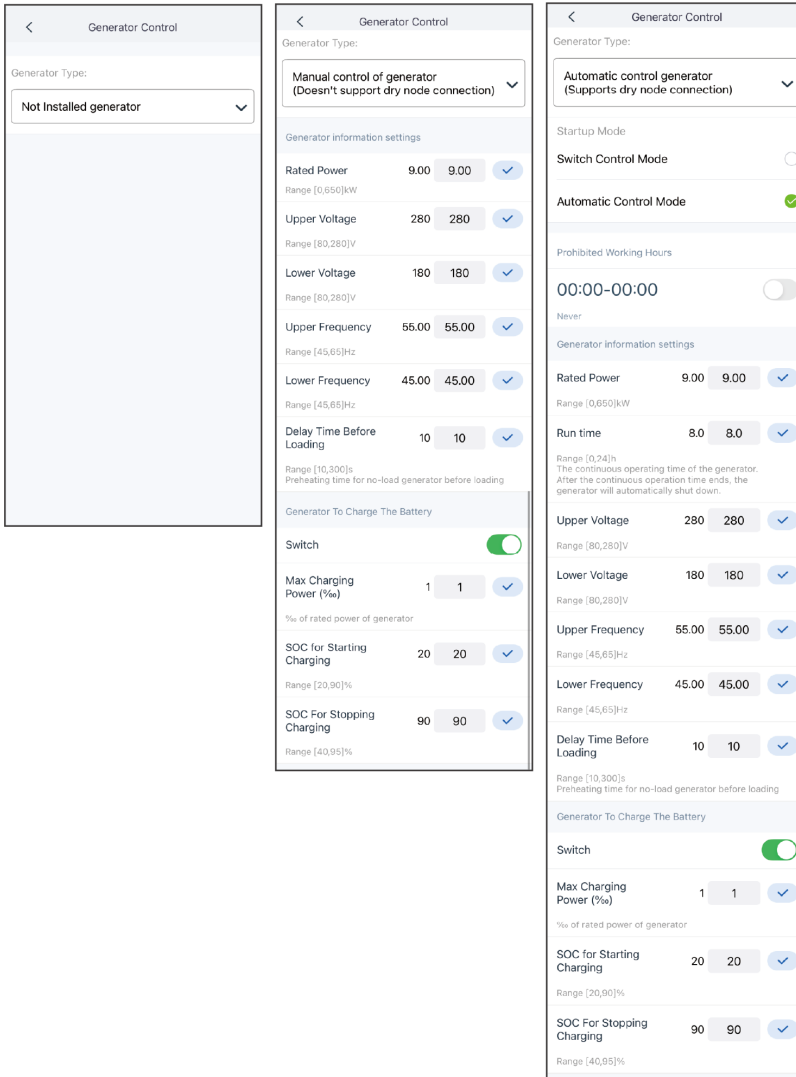

SLG00CON0079

No.	Parameters	Description
1	Startup Mode	Switch Control Mode/Automatic Control Mode
Switch Control Mode		

No.	Parameters	Description
2	Generator Dry Node Switch	Only for Switch Control Mode.
3	Run Time	Set the generator's continuous runtime, after which the generator will be turned off.
Automatic Control Mode		
4	Prohibited Working Hours	Set the time period during which the generator cannot work.
5	Run Time	Set the generator's continuous runtime, after which the generator will be turned off. If the generator start-up operation time includes prohibited working time, the generator will stop running during this time period; after the prohibited working time, the generator will restart running and timing.

No.	Parameters	Description
Generator Information Settings		
1	Rated Power	Set the rated power of the generator.
2	Run Time	Set the continuous running time of the generator. The generator will be shut down after the continuous running time ends.
3	Upper Voltage	Set the operation voltage range of the generator.
4	Lower Voltage	
5	Frequency Cap	Set the operation frequency range of the generator.
6	Lower Frequency	
7	Preheating time	Set the generator no-load preheating time.
Parameter settings for generator charging batteries		
8	Switch	Select whether to use the generator to generate electricity to charge the battery.

No.	Parameters	Description
9	Max.charging power (%)	The charging power when the generator generates electricity to charge the battery.
10	Start charging SOC	When the battery SOC is lower than this value, the generator generates electricity to charge the battery.
11	Stop charging SOC	When the battery SOC is higher than this value, stop charging the battery.

### 9.2.13.3 Setting Microgrid Parameters

#### NOTICE

When the inverter supports microgrid function, you can set microgrid parameters through SolarGo App.

**Step 1** : Tap **Home > Settings > Port Connection** to set the parameters.

**Step 2** : According to the actual interface prompts, enter the microgrid control interface and set the microgrid parameters according to actual needs.

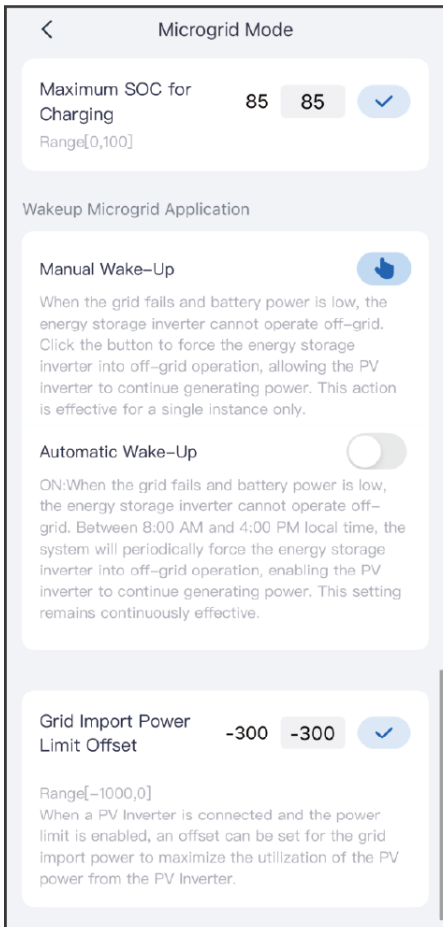

SLG00CON0078

No.	Parameters	Description
1	Maximum SOC for Charging	Set the upper limit of charging SOC, and stop charging when the upper limit is reached.
2	Manual wake-up	<ul style="list-style-type: none"> <li>When the grid fails, if the battery power is low, the energy storage inverter cannot be supported to work off the grid. Click this button to force the energy storage inverter to output voltage to the grid-connected inverter, thereby starting the grid-connected inverter.</li> <li>Single effect.</li> </ul>

No.	Parameters	Description
3	Automatic wake-up	<ul style="list-style-type: none"> <li>When the grid fails, if the battery power is low, the energy storage inverter cannot be supported to work off the grid. After enabling this function, the system will force the energy storage inverter to output voltage to the grid-connected inverter at a fixed time, thereby starting the grid-connected inverter.</li> <li>Multiple effect.</li> </ul>
4	Grid Import Power Limit Offset	Set the adjustable range of the maximum power that the device can actually buy from the grid.

## 9.2.14 Equipment Maintenance

### 9.2.14.1 Checking Firmware Information/Upgrading Firmware Version

Upgrade the DSP version, ARM version, BMS version, AFCI version, or STS version of the inverter, or firmware version of the communication module. Some devices do not support upgrading the firmware version through SolarGo app.

#### NOTICE

If the Firmware Upgrade dialog box pops up once logging into the app, click Firmware Upgrade to directly go to the firmware information page.

#### 9.2.14.1.1 Regular Upgrade

## NOTICE

- When there is a red dot on the right side of the firmware information, please click to view the firmware update information.
- During the upgrade process, please ensure that the network is stable and the device is connected to SolarGo, otherwise the upgrade may fail.

**Step 1 :** Tap **Home > Settings > Firmware Information** to check the firmware version. If the firmware upgrade dialog box pops up, tap **Firmware Upgrade** and turn to the upgrade interface.

**Step 2 :** (Optional) Tap **Check For Update** to confirm whether the latest firmware version is available for updating.

**Step 3:** Tap **Firmware Upgrade** to enter the firmware upgrade interface.

**Step 4 :** (Optional) Tap **Learn More** to view firmware-related information, such as the current version, the latest version, firmware update records, etc.

**Step 5 :** Tap **Upgrade** and complete the upgrade according to the prompts on the interface.

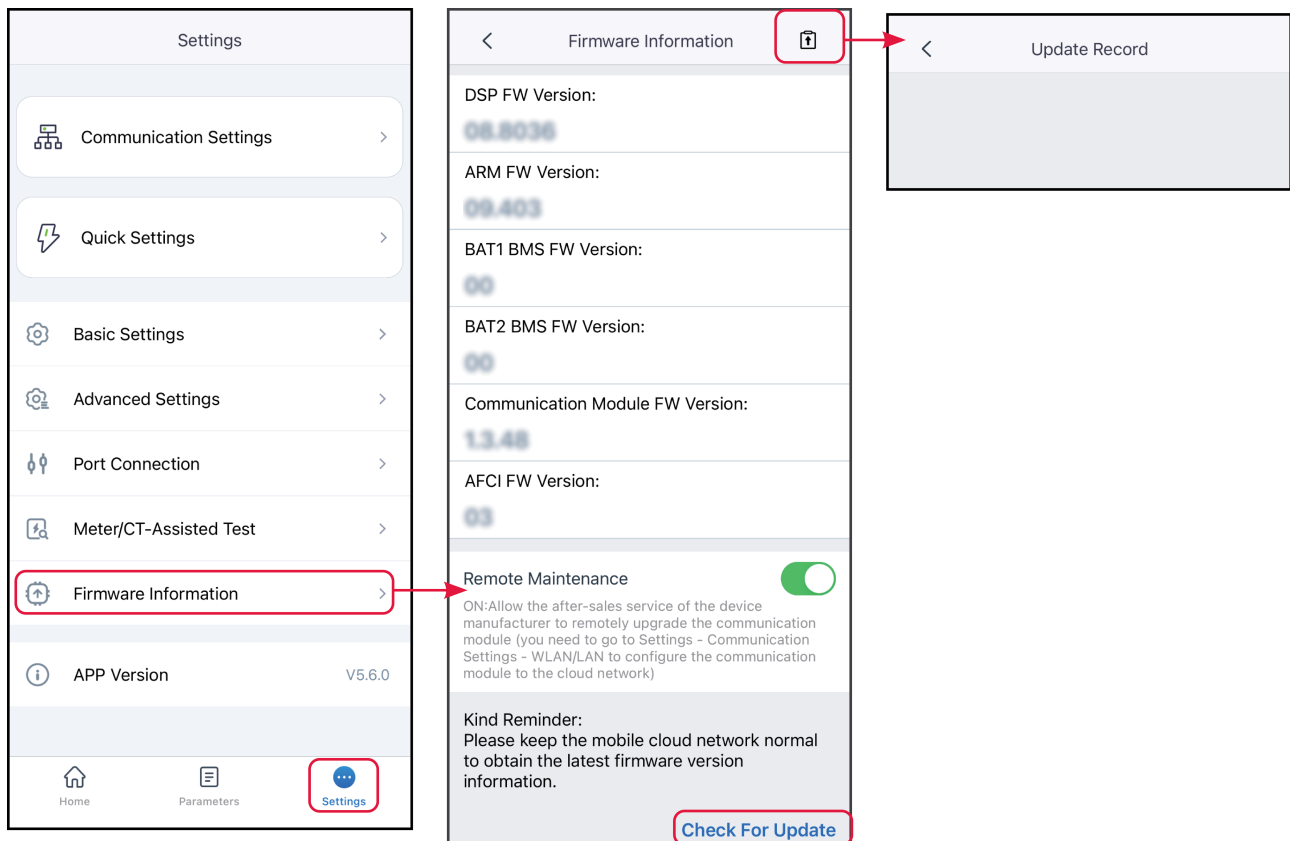

#### 9.2.14.1.2 One-click Upgrade

### NOTICE

- When there is a red dot on the right side of the firmware information, please click to view the firmware update information.
- During the upgrade process, please ensure that the network is stable and the device is connected to SolarGo, otherwise the upgrade may fail.

**Step 1 :** Tap **Home > Settings > Firmware Information**. Tap **Firmware Information** as prompted to enter the firmware upgrade page.

**Step 2 :** Tap **Upgrade** and follow the prompts to complete the upgrading. If you only need to upgrade a specific firmware version, tap **Learn More** to check the firmware related information and tap **Firmware Upgrade** below the firmware version you want to upgrade, and follow the on-screen prompts to complete the operation.

**Step 3 :** Tap **Learn More** to view all current firmware version information.

**Step 4:** (Optional) Tap , to view the version upgrade record.

#### 9.2.14.1.3 Automatic Upgrade

### NOTICE

- When using WiFi/LAN Kit-20 or WiFi Kit-20 module communication and the module firmware version is V2.0.1 or above, the device automatic upgrade function can be enabled.
- After the device automatic upgrade function is enabled, if the module version is updated and the device has been connected to the network, the corresponding firmware version can be automatically upgraded.

**Step 1 :** Tap **Home > Settings > Firmware Information**.

**Step 2 :** Enable or disable the automatic device upgrade function according to actual needs.

#### 9.2.14.2 Change the Login Password

## NOTICE

The login password can be changed. Keep the changed password in mind after changing it. Contact the after-sales service if you forget the password.

**Step 1** : Tap **Home > Settings > Change Login Password** to change the password.

**Step 2** : Change the password based on actual needs.

< Change Login Password Save

Please enter the new password 

Please enter new password again 

Note: 8-16 characters, need a combination of numbers and uppercase or lowercase letters (0-9, a-z, A-Z)

SLG00CON0088

## 10 Station Monitoring

### NOTICE

The parameters may vary depending on the account type or power station type.  
The actual interface takes precedence.

### 10.1 Product Introduction

SEMS+ App is a monitoring platform to manage power plants and devices, and check the operating data and alarming information of the power plant.

#### 10.1.1 Applicable Product Model

SEMS+ App can be used to monitor and manage GoodWe products, such as inverters, smart meters, smart loggers,chargers, batteries and so on.

#### 10.1.2 Downloading and Installing the App

**Make sure that the mobile phone meets the following requirements:**

- Operating system: Android 6.0 or later, iOS 13.0 or later.
- Internet connection via browser.
- WLAN/Bluetooth capabilities.

#### Download Methods:

##### Method I

Search SEMS+ on Google Play (Android) or App Store (iOS) to download and install the App.

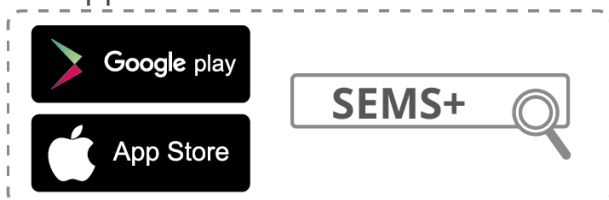

SEMS0001

##### Method II

Scan the QR code below to download and install the App.



### 10.1.3 App Connection

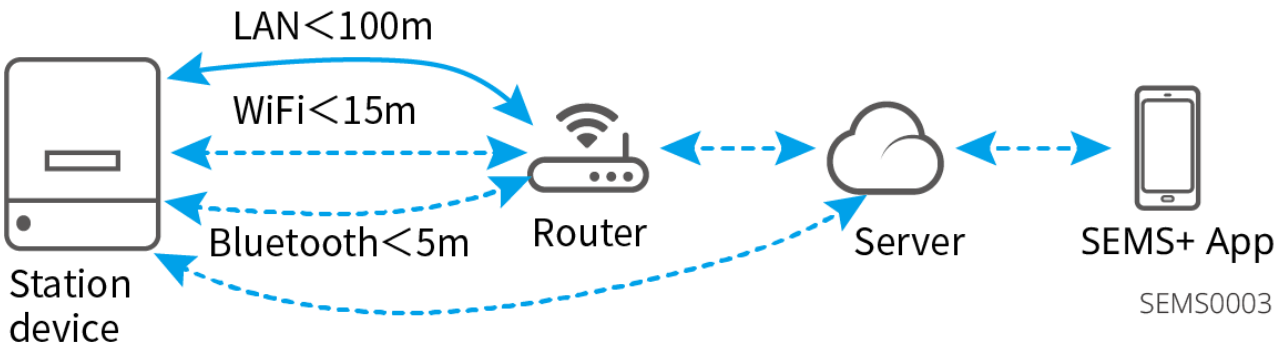

### 10.1.4 Setting Language and Server

#### NOTICE

The server is automatically matched based on login account information. To set it manually, ensure that the selected region matches the region of the account. Otherwise, login may fail.

Select the language and the server based on the actual situation.

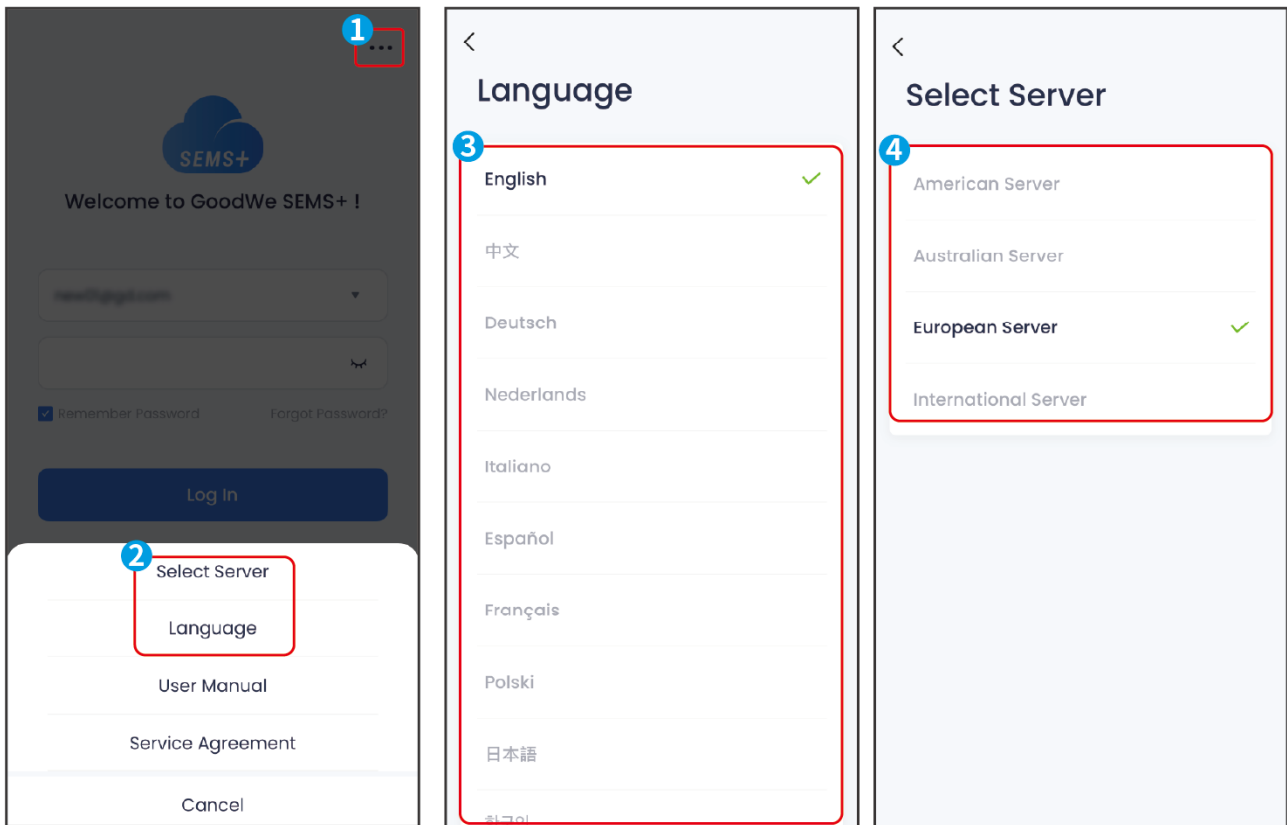

### 10.1.5 Setting the Network Information

The SEMS+ App allows connecting devices via Bluetooth or WiFi and configuring network parameters to realize remote monitoring or management.

#### NOTICE

The device name varies depending on the inverter model or smart dongle model.

- Wi-Fi/LAN Kit, Wi-Fi Kit, Wi-Fi Box: Solar-WiFi\*\*\*
- WiFi/LAN Kit-20: WLA-\*\*\*
- WiFi Kit-20: WFA-\*\*\*
- Ezlink3000: CCM-BLE\*\*\*, CCM-\*\*\*, \*\*\*
- 4G Kit-CN-G20/4G Kit-CN-G21: GSA-\*\*\*; GSB-\*\*\*
- AC Charger:\*\*\*

## 10.2 Managing the Account

## 10.2.1 Registering an Account

**Step 1:** Tap **Register** to enter the account registration interface.

**Step 2:** Select the account type based on your actual needs and tap **Next**.

**Step 3:** Enter your account information based on the actual situation and tap **Register** to complete the registration.

SEMS0005

The image displays three sequential screenshots of the account registration process in the SEMS+ app. The first screenshot shows the login screen with a 'Register' button highlighted with a red circle and the number 1. The second screenshot shows the 'Account Type' screen with two options: 'Owner' and 'Dealer/Installer', with the 'International Server' dropdown highlighted with a red circle and the number 2, and the 'Next' button highlighted with a red circle and the number 4. The third screenshot shows the 'Account Details' screen with fields for Country/Region, User Name, Email, Verification Code, and Password, with the 'Register' button highlighted with a red circle and the number 6.

## 10.2.2 Logging in to the App

### NOTICE

- Register an account or obtain an account from your dealer before logging in.
- Check and manage power station after logging in. The actual interface takes precedence.

**Step 1:** Enter the username and password, read, and agree to the login agreement. Tap **Log In**.

SEMS0006

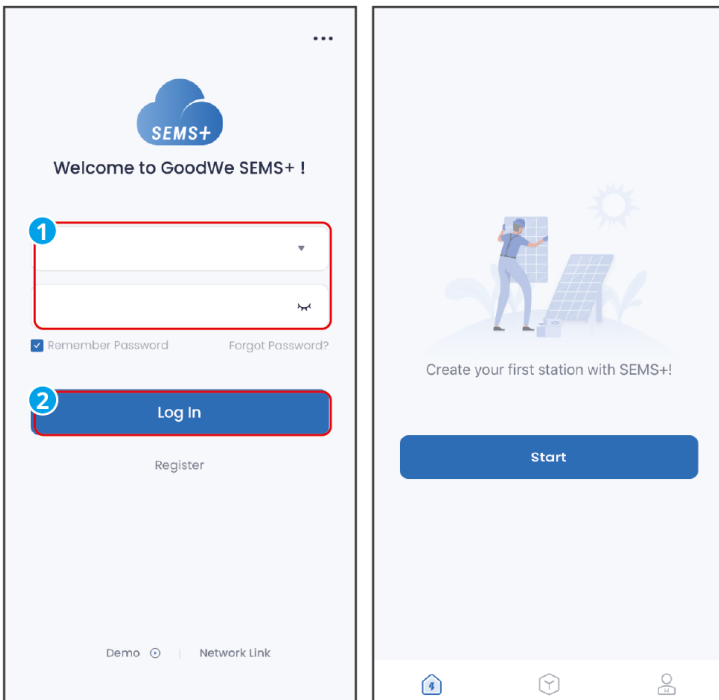

### 10.2.3 Switching Accounts

**Step 1:** Go to **My** tab, and tap **Log Out** > **Log with Another Account**.

**Step 2:** Select an already added account or add a new account based on actual needs.

SEMS0007

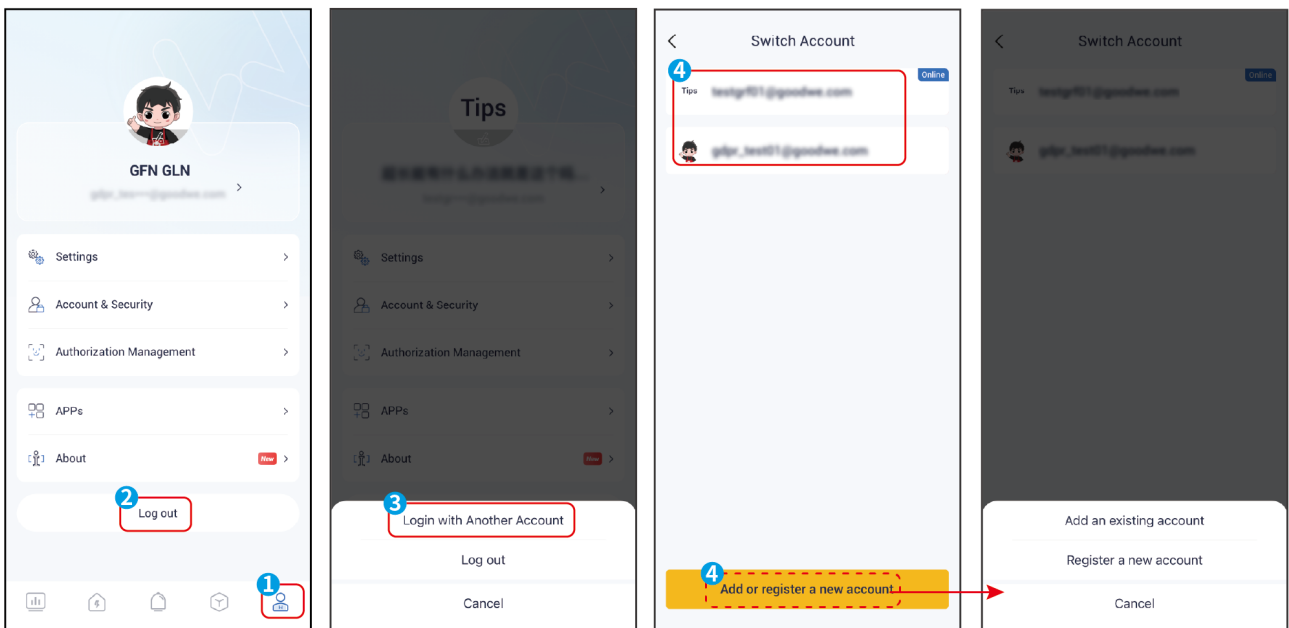

### 10.2.4 Deleting an Account

**Step 1:** Go to **My** tab and tap **Account&Security**.

**Step 2:** Tap **Close Account**, input the account password, and **Submit**.

SEMS0008

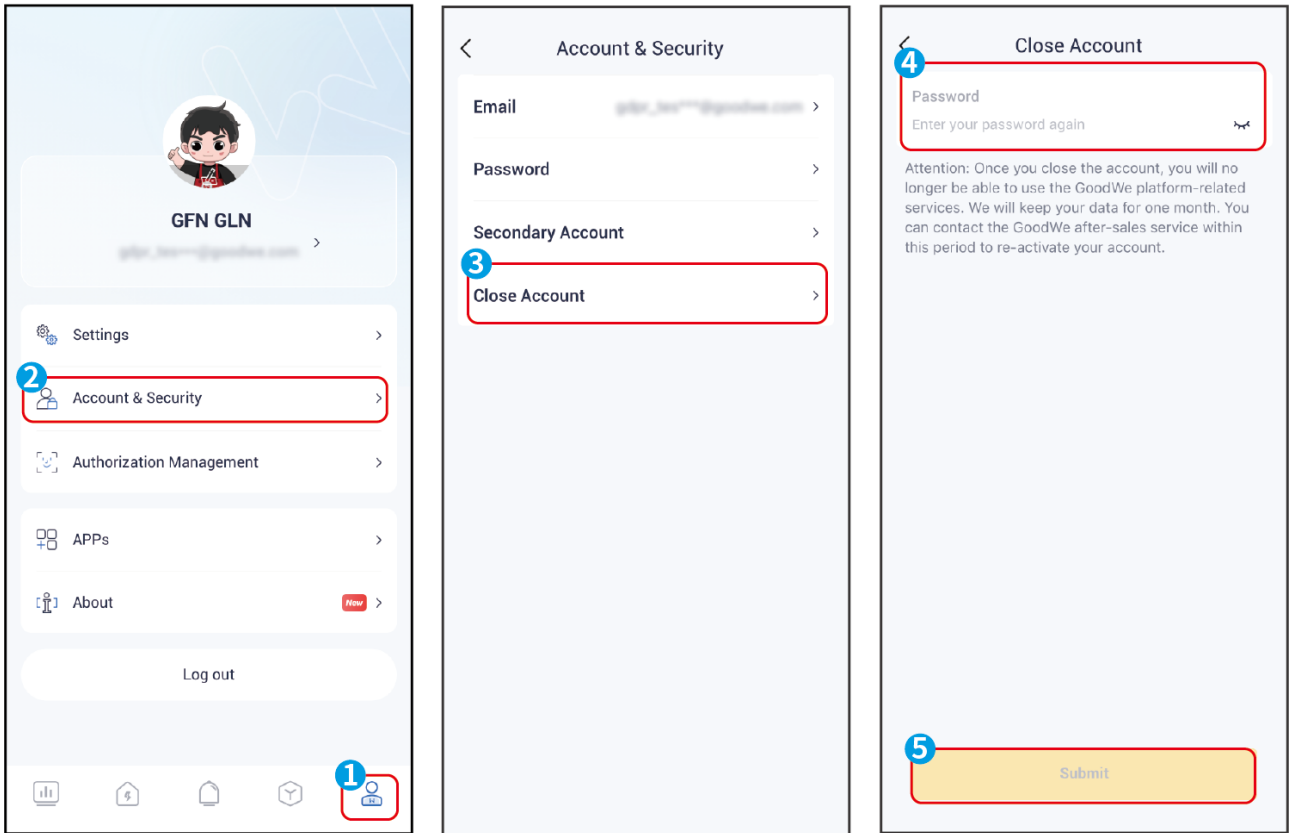

## 10.2.5 Account Permission Descriptions

The SEMS+ App supports various types of accounts with different permissions. Refer to the table below for details.

Primary menu	Submenu	Third-Level Menu	Fourth-Level Menu	Fifth-Level Menu	Permissions
Login & Register	-	-	-	-	Administrator, Technician, Browser, End User, Visitor
Overview	Monitoring Information	-	-	-	Administrator, Technician, Browser, End User, Visitor
	Create Station	-	-	-	Administrator, Technician, End User and Visitor

Station	Station List	-	-	-	Administrator, Technician, Browser, End User, Visitor		
	Station Details	Monitoring	-	-	Administrator, Technician, Browser, End User, Visitor		
		Device	Add Device	-	-	Administrator, Technician, End User	
			Device List	Search Device	-	-	Administrator, Technician, Browser, End User, Visitor
				Replace Device	-	-	Administrator, Technician, End User
				Edit Device	-	-	Administrator, Technician, End User
				Delete Device	-	-	Administrator, Technician, End User
			Device Details	Device Monitoring Info	-	-	Administrator, Technician, Browser, End User, Visitor
				Device Remote Control	-	-	Administrator, Technician, End User
		Device Remote Upgrade		-	-	Administrator, Technician	
		Alarms	-	-	-	Administrator, Technician, Browser, End User, Visitor	
		Station Configuration	Edit Station	-	-	Administrator, Technician, End User	
			Delete Station	-	-	Administrator, Technician, End User	
			Replacement	-	-	Administrator,	

			History		Technician, Browser, End User
			User Information	-	Administrator, Technician, End User
			Home Configuration	-	Administrator, Technician, Browser, End User, Visitor
	Create Station	-	-	-	Administrator, Technician, End User and Visitor
Alarm	-	-	-	-	Administrator, Technician, Browser
Services	Services	Warranty	-	-	Administrator, Technician, Browser, End User, Visitor
		Report Center	-	-	Administrator, Technician, Browser, End User
		GoodWe News	-	-	Administrator, Technician, Browser, End User, Visitor
		Announcements	-	-	Administrator, Technician, Browser, End User, Visitor
		Community	-	-	Administrator, Technician, Browser, End User, Visitor
	Tools	Create Station	-	-	Administrator, Technician, End User and Visitor
		Network Link	-	-	Administrator, Technician, Browser, End User, Visitor
		DNSP	-	-	Administrator,

					Technician, Browser, End User, Visitor	
	Help	-	-	-	Administrator, Technician, Browser, End User, Visitor	
My	User Profile	-	-	-	Administrator, Technician, Browser, End User, Visitor	
	User Information	-	-	-	Administrator, Technician, Browser, End User, Visitor	
	Setting	-	-	-	Administrator, Technician, Browser, End User, Visitor	
	Account Security	Email	-	-	-	Administrator, Technician, Browser, End User, Visitor
		Password	-	-	-	Administrator, Technician, Browser, End User, Visitor
		Secondary Account	-	-	-	Administrator, Technician, Browser
		Close Account	-	-	-	Administrator, Technician, Browser, End User, Visitor
	Auth Management	Remote Control Auth	-	-	-	Administrator, Technician, Browser, End User, Visitor
		Monitoring Auth	-	-	-	End User
	Apps	-	-	-	Administrator, Technician, Browser, End User, Visitor	
About	-	-	-	Administrator,		

					Technician, Browser, End User, Visitor
	Logout	Logout	-	-	Administrator, Technician, Browser, End User, Visitor
		Login another Account	-	-	Administrator, Technician, Browser, End User, Visitor

## 10.3 Setting the Network Information

The SEMS+ App allows connecting devices via Bluetooth or WiFi and configuring network parameters to realize remote monitoring or management.

### NOTICE

The device name varies depending on the inverter model or smart dongle model.

- Wi-Fi/LAN Kit, Wi-Fi Kit, Wi-Fi Box: Solar-WiFi\*\*\*
- WiFi/LAN Kit-20: WLA-\*\*\*
- WiFi Kit-20: WFA-\*\*\*
- Ezlink3000: CCM-BLE\*\*\*, CCM-\*\*\*, \*\*\*
- 4G Kit-CN-G20/4G Kit-CN-G21: GSA-\*\*\*; GSB-\*\*\*
- AC Charger:\*\*\*

### 10.3.1 Connecting via Bluetooth

### NOTICE

- Before connecting, ensure: Your phone's Bluetooth is enabled. The device is powered on and communicating properly.
- The App interface and parameters may vary depending the device type or smart dongle model. The actual interface takes precedence.

**Step 1:** Open the app and select **Network Link** on the homepage or in the **Service** interface.

**Step 2:** Tap **Bluetooth** and select the device by the serial number.

**Step 3 :** If prompted, log into the App according to your role and enter the password. Default password: 1234. If no login prompt appears, you will directly enter the communication settings interface.

**Step 4:** (Optional) Enable **Bluetooth Stays ON** if required. Otherwise, the Bluetooth signal will turn off after the connection.

**Step 5:** Set the **WLAN** or **LAN** parameters based on actual situation. Tap **Save** to complete the settings. Tap **WLAN Detetion** to check the communication status.

**Step 6:** (Optional) Tap **Login Password Change** to input a new password, and **Save**.

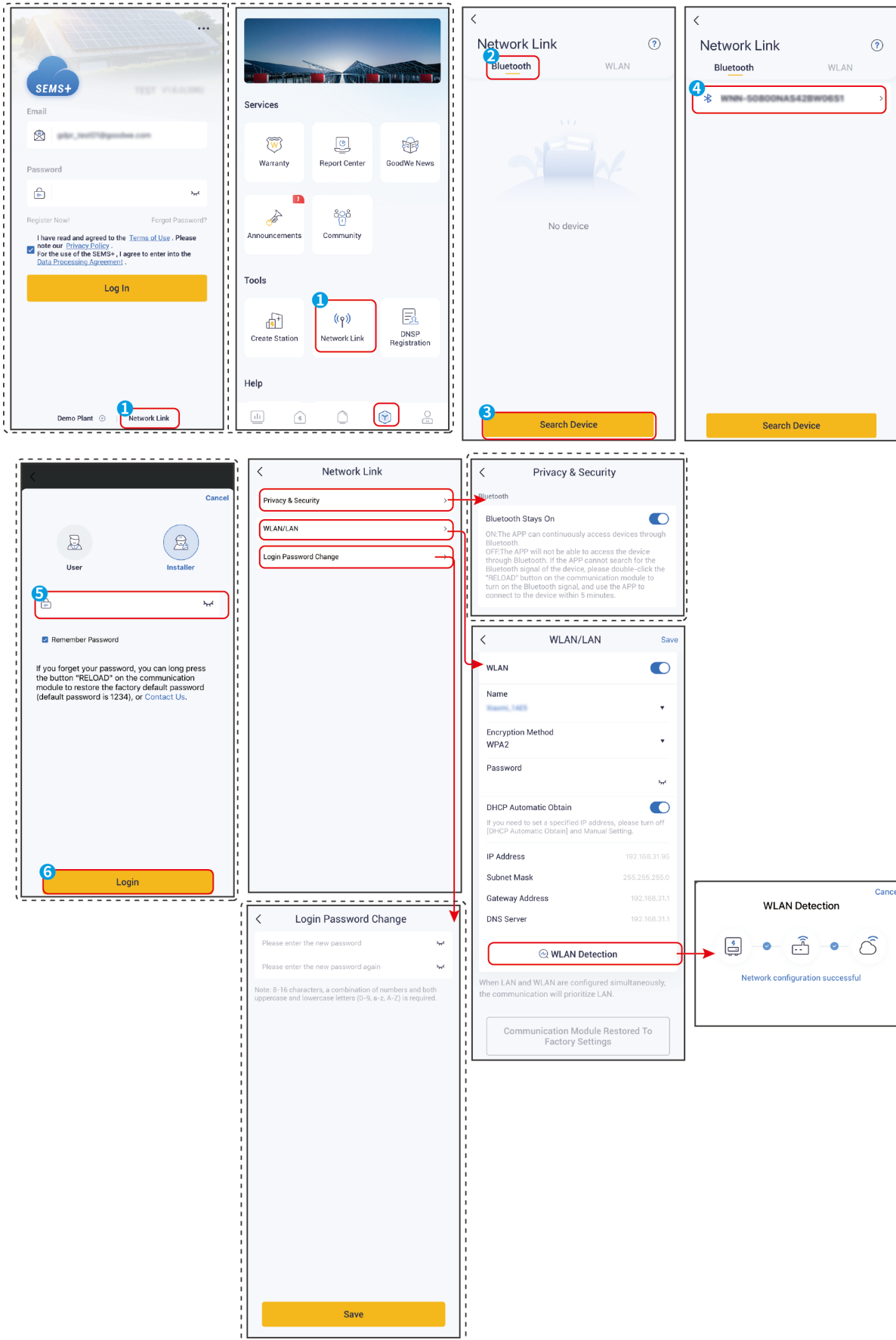

No.	Parameters	Description
Privacy&Security		
1	Bluetooth Stays ON	Enable the function, the bluetooth of the device will be contentions on to keep connected to SEMS+. Otherwise, the bluetooth will be off in 5 minutes.
WLAN/LAN		
2	WLAN	Enable or disable WLAN.
3	Name	Select the name of the router network to be used.
4	Encryption Method	
5	Password	
6	DHCP Automatic Obtain	Enable DHCP when the router is in dynamic IP mode. Disable DHCP when a switch is used or the router is in static IP mode.
7	IP Address	Do not configure the parameters when DHCP is enabled. Configure the parameters according to the router or switch information when DHCP is disabled.
8	Subnet Mask	
9	Gateway Address	
10	DNS Server	

### 10.3.2 Connecting via WiFi

#### NOTICE

- Before connecting, ensure: Your phone's Bluetooth is enabled. The device is powered on and communicating properly.
- The App interface and parameters may vary depending the device type or smart dongle model. The actual interface takes precedence.

**Step 1:** Open the WiFi setting on the phone and connect to the inverter's WiFi signal (Solar-WiFi\*\*\*). Default password: 12345678

**Step 2:** Open the app and select **Network Link** on the homepage or in the **Service** interface.

**Step 3:** Tap **WLAN** and select the device by the serial number.

**Step 4:** Modify the WiFi hotspot password if needed. If changed, reconnect to the inverter's WiFi signal using the new password.

**Step 5:** Set the **WLAN** or **LAN** parameters based on actual situation. Tap **Save** to complete the settings. Tap **WLAN Detetion** to check the communication status.

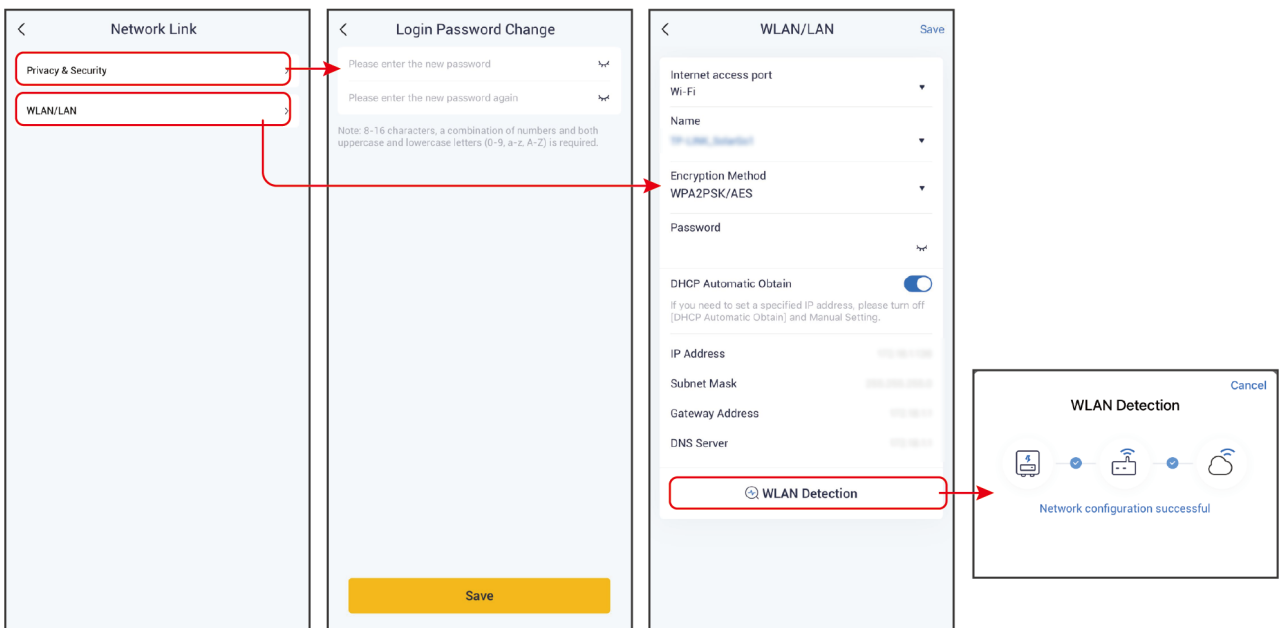
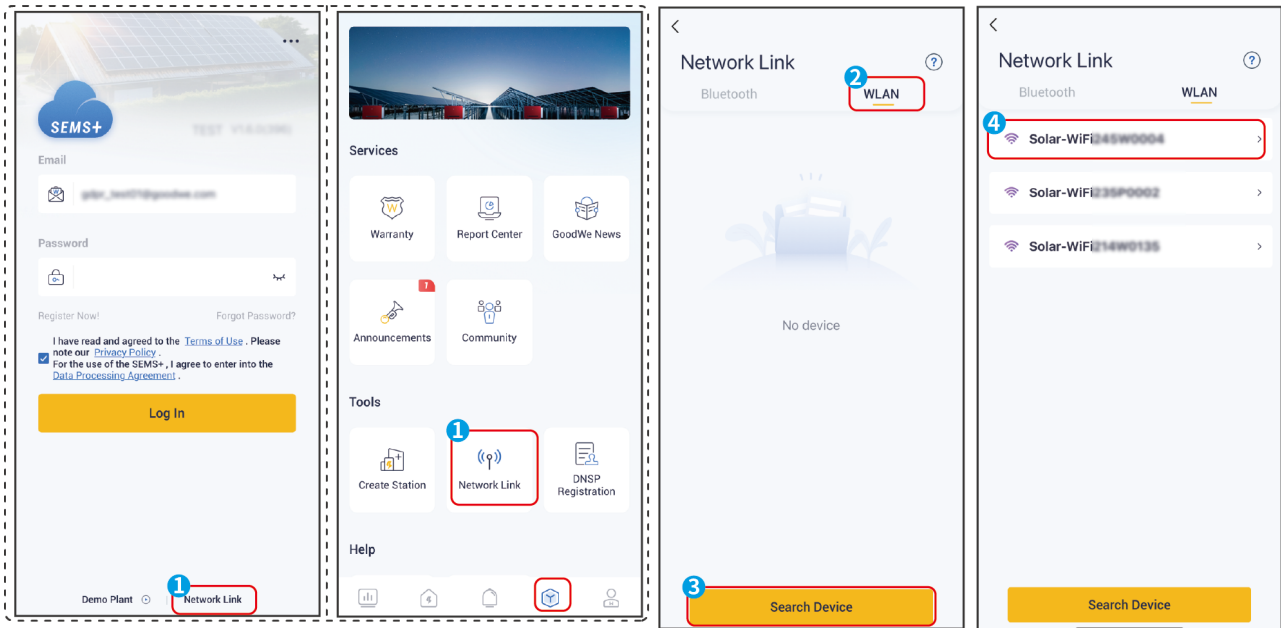

No.	Parameters	Description
Privacy&Security		
1	Login Password Change	Modify the WiFi hotspot password if needed. If changed, reconnect to the inverter’s WiFi signal using the new password.
WLAN/LAN		
2	Internet Access Port	Set the communication mode as <b>Wi-Fi</b> or <b>LAN</b> based on actual needs.

No.	Parameters	Description
3	Name	Select the name of the router network to be used.
4	Encryption Method	
5	Password	
6	DHCP Automatic Obtain	Enable DHCP when the router is in dynamic IP mode. Disable DHCP when a switch is used or the router is in static IP mode.
7	IP Address	Do not configure the parameters when DHCP is enabled. Configure the parameters according to the router or switch information when DHCP is disabled.
8	Subnet Mask	
9	Gateway Address	
10	DNS Server	

## 10.4 Checking Station Information

### 10.4.1 Checking Overview Information of All Stations

After logging in, you can view an overview of all stations linked to your account from the homepage.

Or sort the list of all power stations through different sorting and filtering conditions on the power station page to view the detailed information of the power stations.

SEMS0018

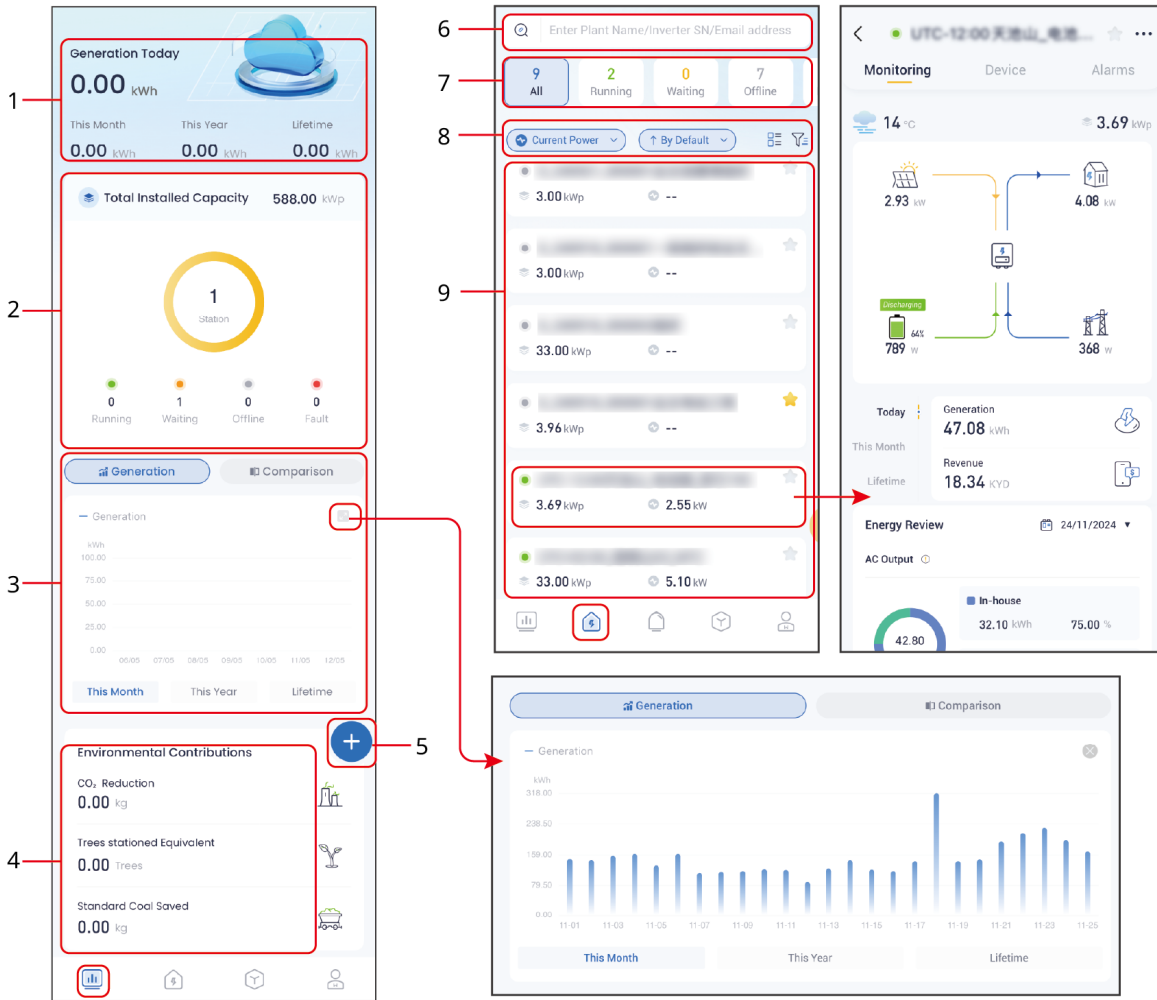

No.	Description
1	Displays the overall generation information of all stations, including: Generation Today, Generation This Month, Generation This Year, and Generation Lifetime. Generation This Year will not be displayed if the station amount exceeds 10.
2	Displays the total installed capacity and the working status of the stations. Working status: Running, Waiting, Offline, and Faulted. The stations status is running only when all the devices of the station are working properly.
3	Displays statistical chart of Generation Today, This Year, and Lifetime.Or displays comparison chart comparing current and past generation. Tap  to expand the chart.
4	Displays environmental contributions like <b>CO<sub>2</sub> Reduction</b> , <b>Trees Stationed Equivalent</b> , and <b>Standard Coal Saved</b> .
5	Creating a New Station

No.	Description
6	Searching Stations Enter the device SN, power station name or email address to quickly search for the corresponding power station.
7	Power station operation status. Display the current operation status of power stations and the number of power stations operating in each status. Tap the operation status to filter power stations in the corresponding operation status.
8	<ul style="list-style-type: none"> <li>• Set KPI indicators displayed in the power station list: Current Power, Rev. Today, Rev. Total, Gen. Today, Gen. Total</li> <li>• Set the sorting method of the power station list: By Default, By Capacity</li> <li>• Set the display mode of the power station list: Station Card, Station List</li> <li>• Set the filtering conditions for the power station list: Scope, Category, Capacity</li> </ul>
9	Power station list. Tap the power station name to view the detailed information of the power station. The displayed content varies depending on the station type. The actual interface takes precedence

### 10.4.2 Checking Detailed Information of Single Station

**Step 1:** Enter the device SN, power station name or email address to quickly search for the corresponding power station.

**Step 2:** Tap the power station name to enter the power station details page.

SEMS0052

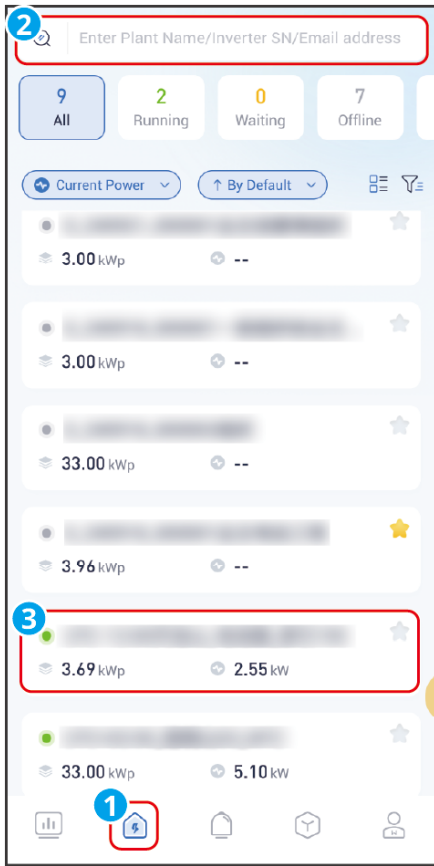

### 10.4.2.1 Checking Detailed Information of Power Station (Traditional Mode)

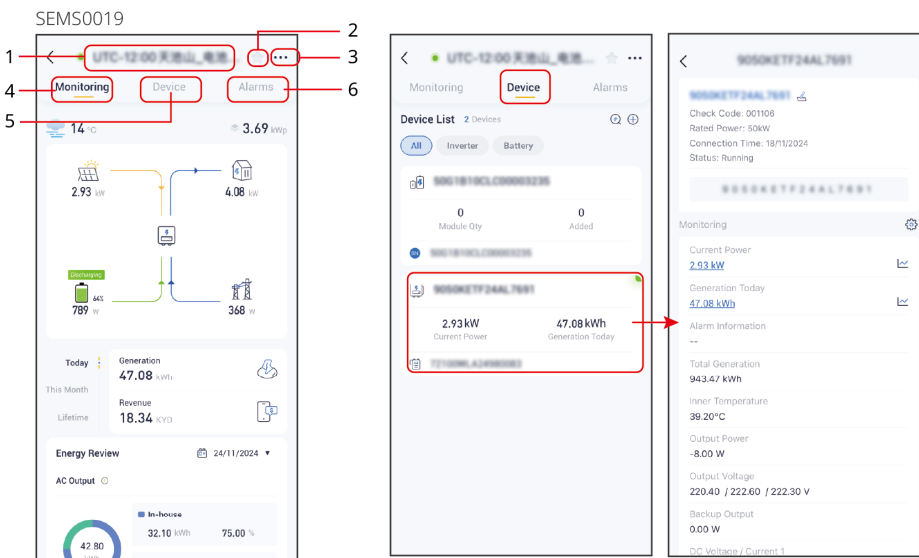

No.	Description
1	The current name of the power station.
2	Favoriting a Station
3	Configuring Station Information. Supported functions: Configure basic information of the power station, modify user information, add power station photos, set PV module layout, etc.
4	Displays current power station operation information in chart form, such as energy flow diagrams, power generation, load power consumption, AC output, and other information.
5	<ul style="list-style-type: none"> <li>• Device List Displays devices in the current power station, such as inverters, batteries, data collectors, charging piles, etc.</li> <li>• Tap the device card to view detailed device information.</li> </ul>
6	Alarm information.

### 10.4.3 Checking Alarm Information

#### 10.4.3.1 Checking Alarm Information of All Power Stations

**Step 1** Tap **Alarms** tab to enter the alarm page.

**Step 2** (optional) Use the search bar to locate alarms by station name or device serial number.

**Step 3** Select the alarm to view detailed information.

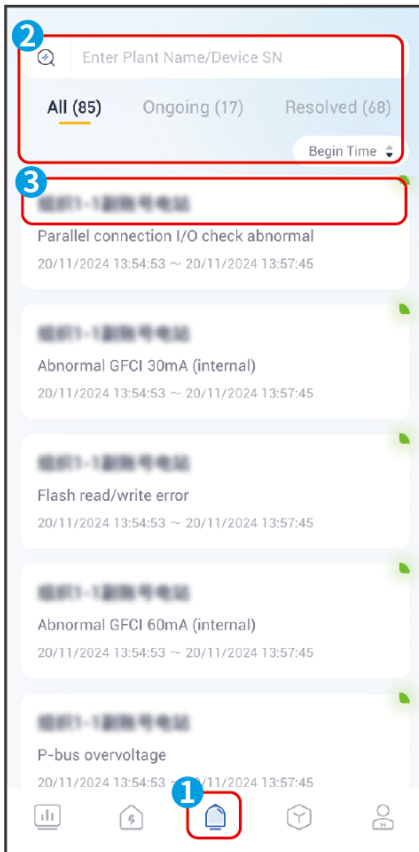

### 10.4.3.2 Checking Detailed Information of Current Power Station (Traditional Mode)

**Step 1:** If there are multiple power stations, tap the power station name to enter the power station details page.

**Step 2:** Tap **Alarms** to enter the alarm page to view alarm details. Tap  to filter alarm information based on actual needs.

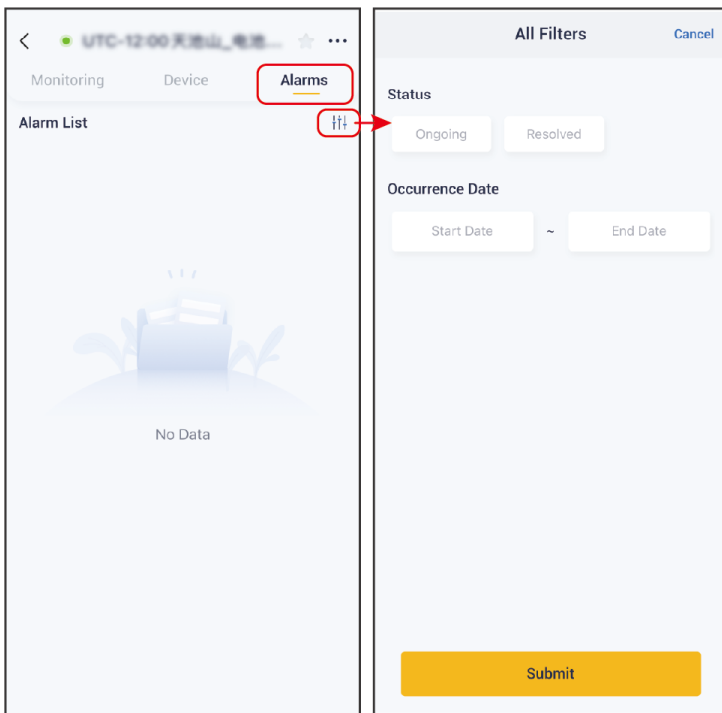

### 10.4.3.3 Checking Alarm Information of Current Devices

**Step 1:** If there are multiple power stations, tap the power station name to enter the power station details page.

**Step 2:** Select a device from the device list and enter the device details page. If there are alarms, the device details page allows direct viewing of the 10 latest ongoing alarms.

SEMS0022

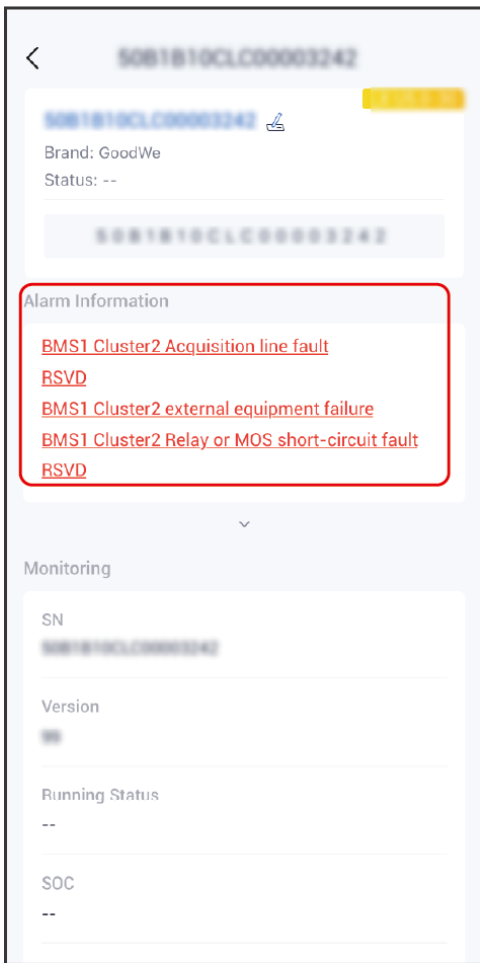

## 10.4.4 Checking Station Reports

### Viewing Reports

**Step 1:** Tap **Service** > **Report Center**.

**Step 2:** Select a time period, search for the desired station, and tap the station name to view the report center. Tap **•••** > **Export** to download the report if needed.



## Viewing Bills

Step 1: Tap Service > Report Center.

**Step 2:** Search for the desired station. Find the station, swipe left and tap  to view billing details of the month.

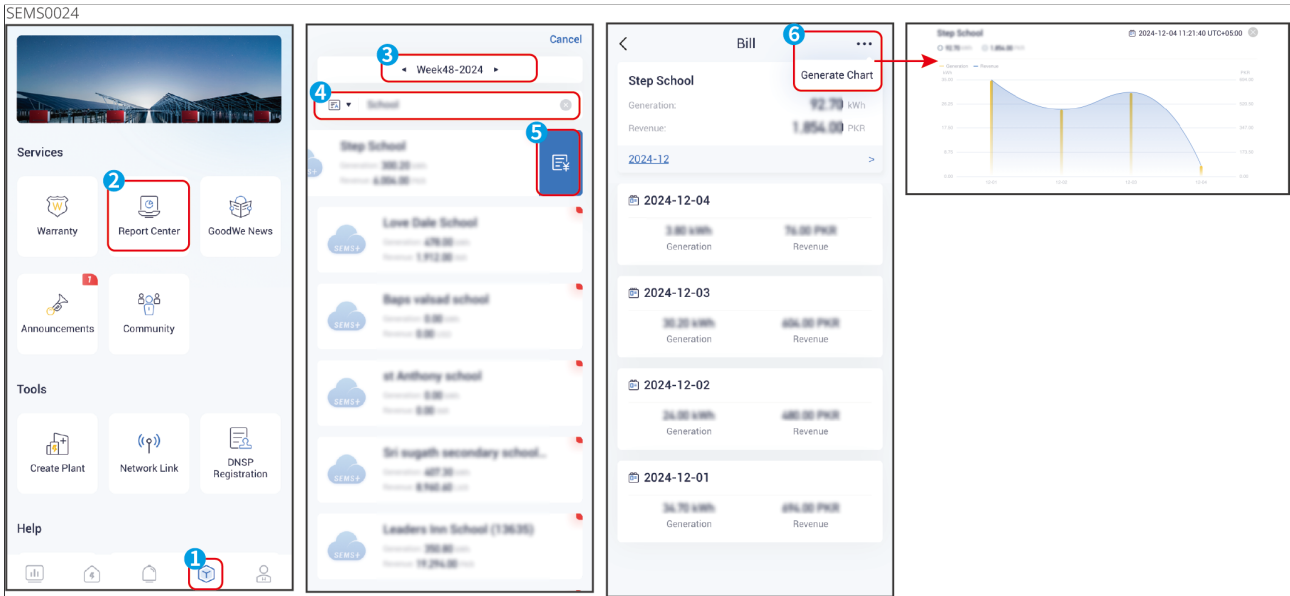

## 10.5 Managing Stations

### 10.5.1 Creating a Station

**Step 1:** Tap  on overview or station page, or tap **Create Station** on service page.

**Step 2:** Enter station information on the **Creat Station** page.

**Step 3:** Tap **Save&Exit** to complete creating a station, without devices added. Or tap **Save&Continue** to add devices. Support adding multiple devices.

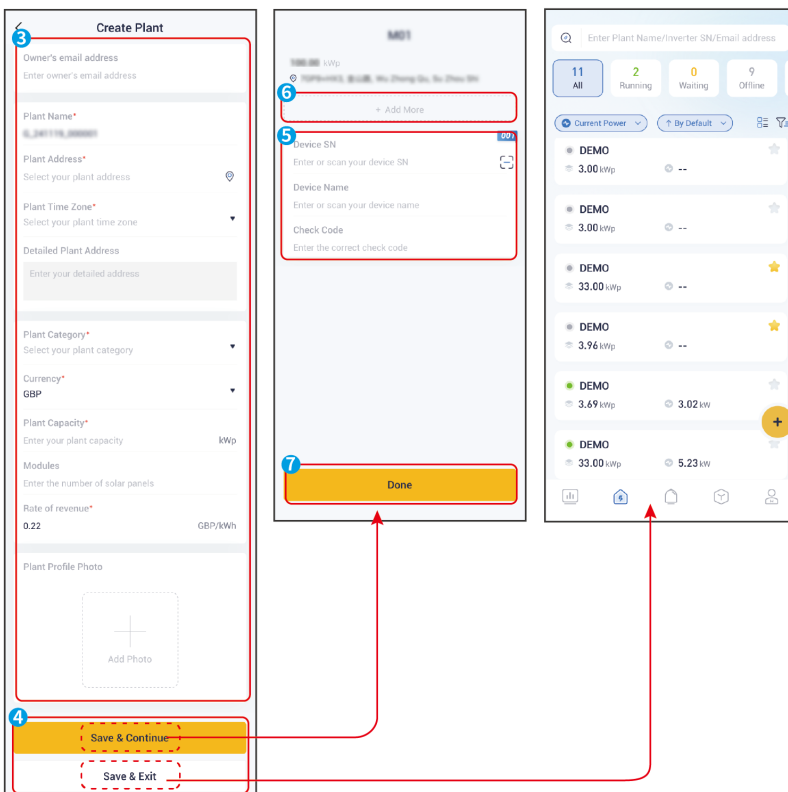
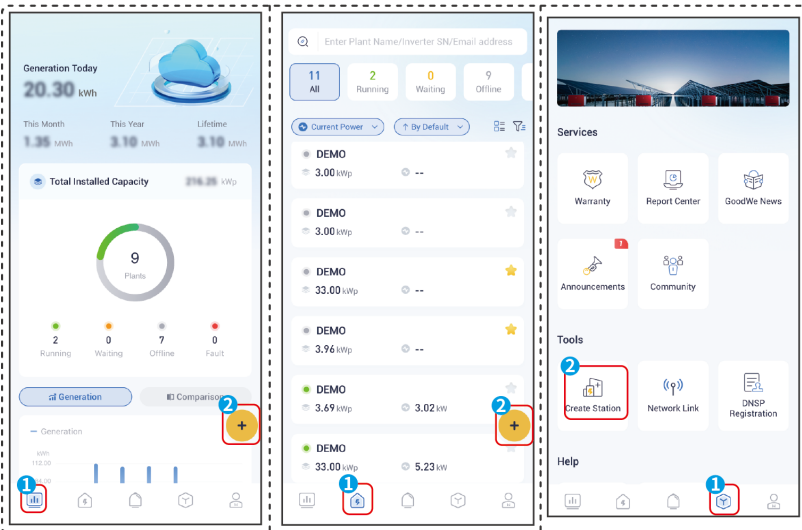

## 10.5.2 Configuring Station Information

### NOTICE

The configuration information of the station can be updated as needed. When the information filled in is inconsistent with the actual situation of the power station, the actual situation of the power station shall prevail.

**Step 1:** (Optional) Select the station to be updated from the station list.

**Step 2:** Tap **⋮** > **Basic Information** to check the basic information.

**Step 3:** Tap **⚙️** to modify the information, and tap **Confirm** to save the changes.

SEMS0012

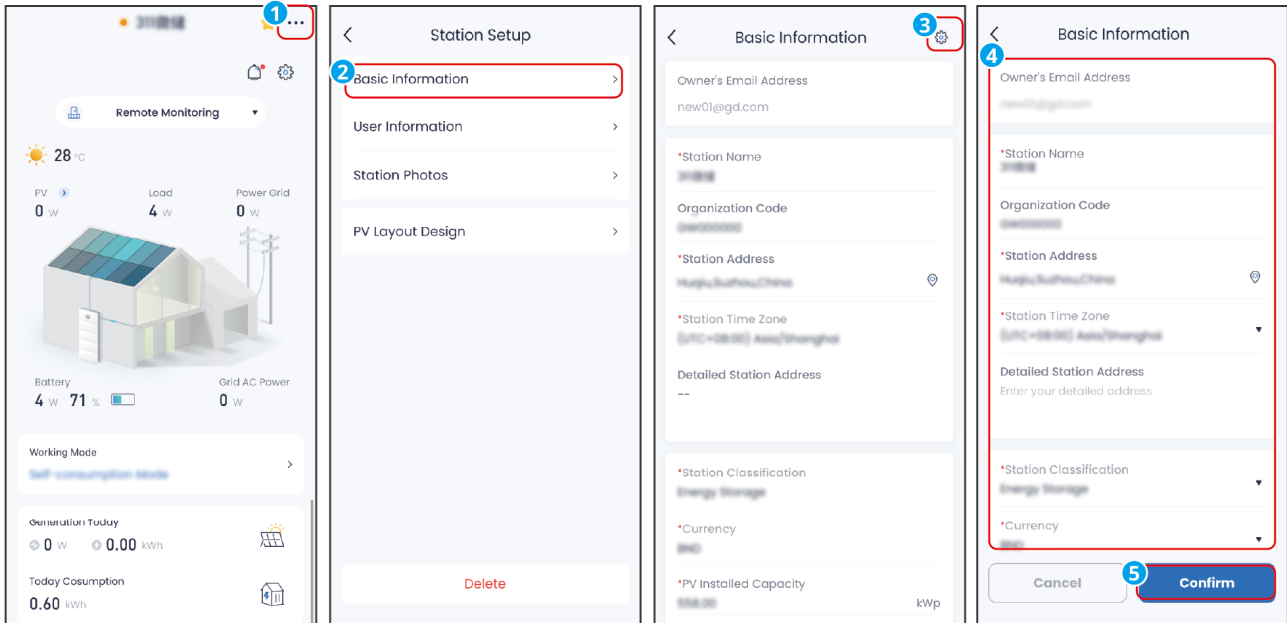

### 10.5.3 Managing Station Visitors

SEMS+ App allows users to add visitors to the power station and view basic information. Visitors have limited access and cannot view all information.

**Step 1:** (Optional) Select the station to be updated from the station list.

**Step 2:** Tap **⋮** > **User Information** > **Add**.

**Step 3:** Input the visitor's information and tap **Confirm**.

SEMS0013

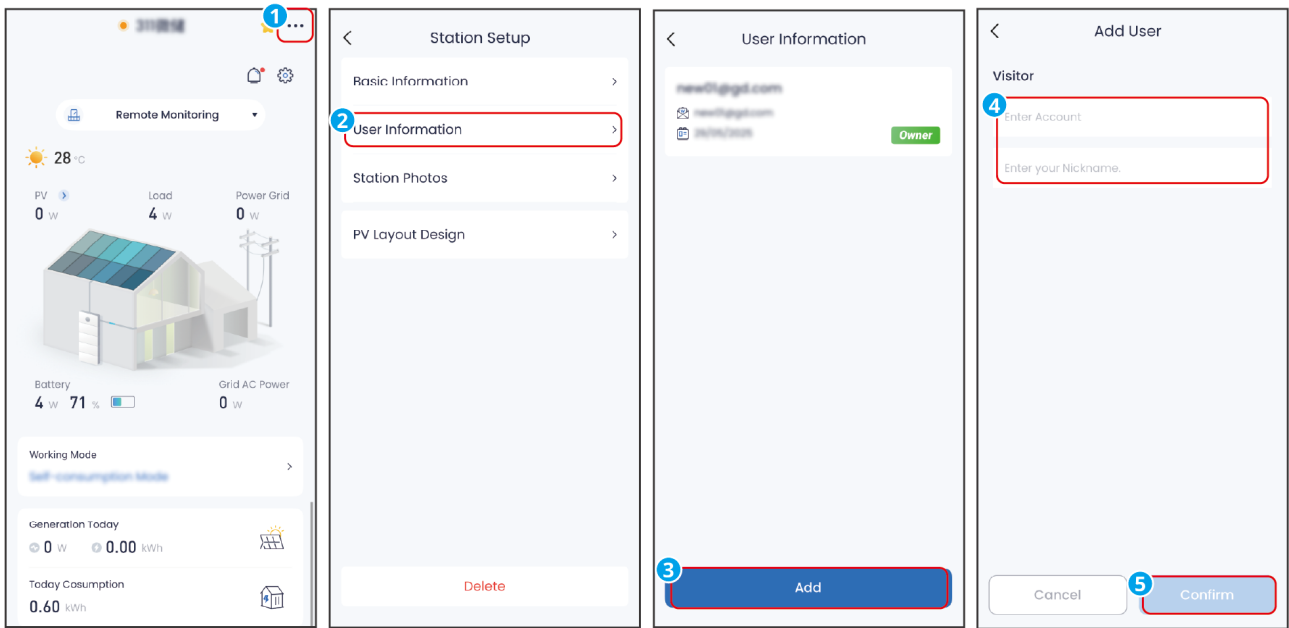

To delete a visitor, go to the User Information page, select the visitor, and tap **Delete**.

SEMS0054

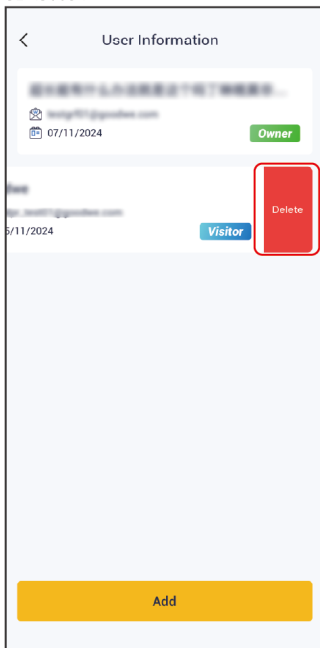

## 10.5.4 Managing Station Photos

Adding photos to a station helps users find what they need faster.

**Step 1:** (Optional) Select the station to be updated from the station list.

**Step 2:** Tap **...** > **Station Photos** > **Add**.

**Step 3:** Follow the prompts to add photos by **Take a Photo** or **Choose from Album**.

SEMS0014

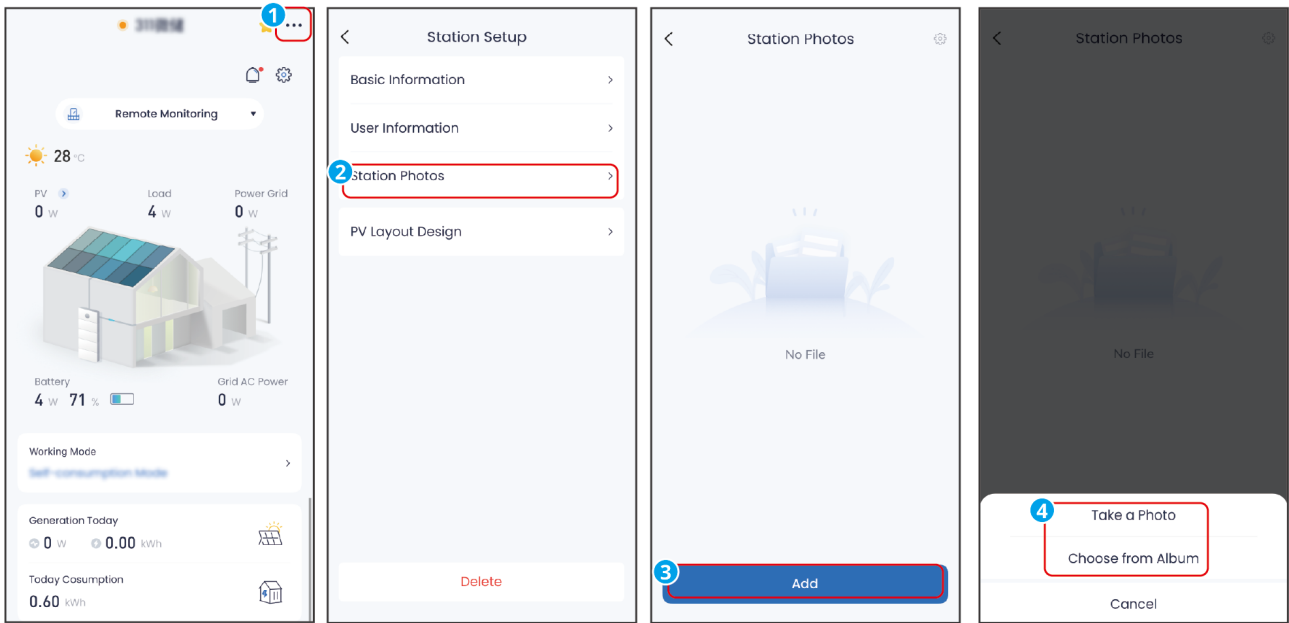

To delete a photo, follow the steps below.

SEMS0055

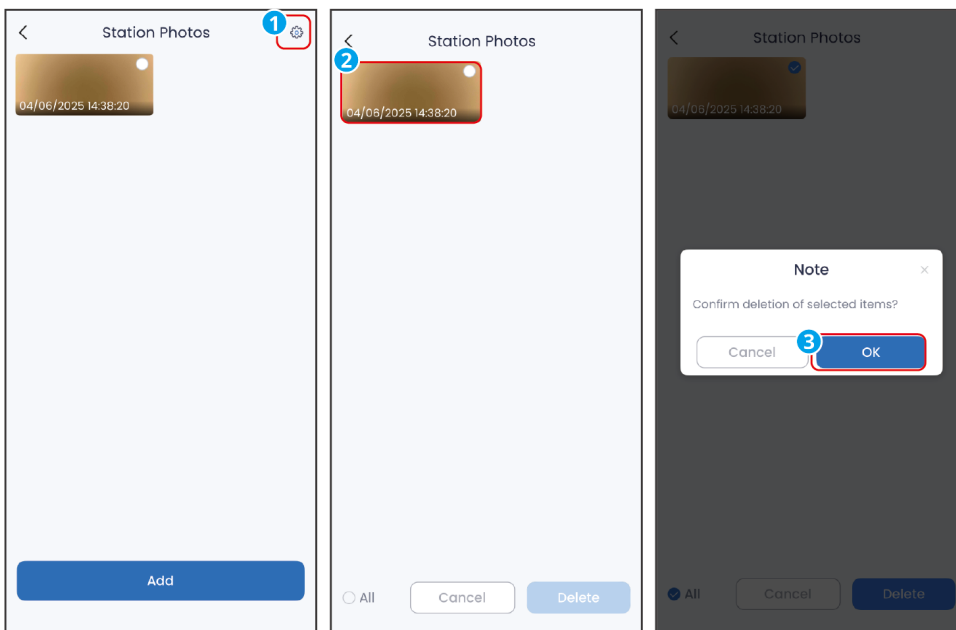

## 10.5.5 Configuring the Page Information

Change what's shown on the station details page, such as showing, hiding, or repositioning the Energy Flow Chart.

**Step 1:** (Optional) Select the station to be updated from the station list.

**Step 2:** Tap **⋮** > **Home Configuration** on the station page.

**Step 3:** Refer to the on-screen prompts to select the information content to be displayed, or adjust the display order of various information based on actual needs.

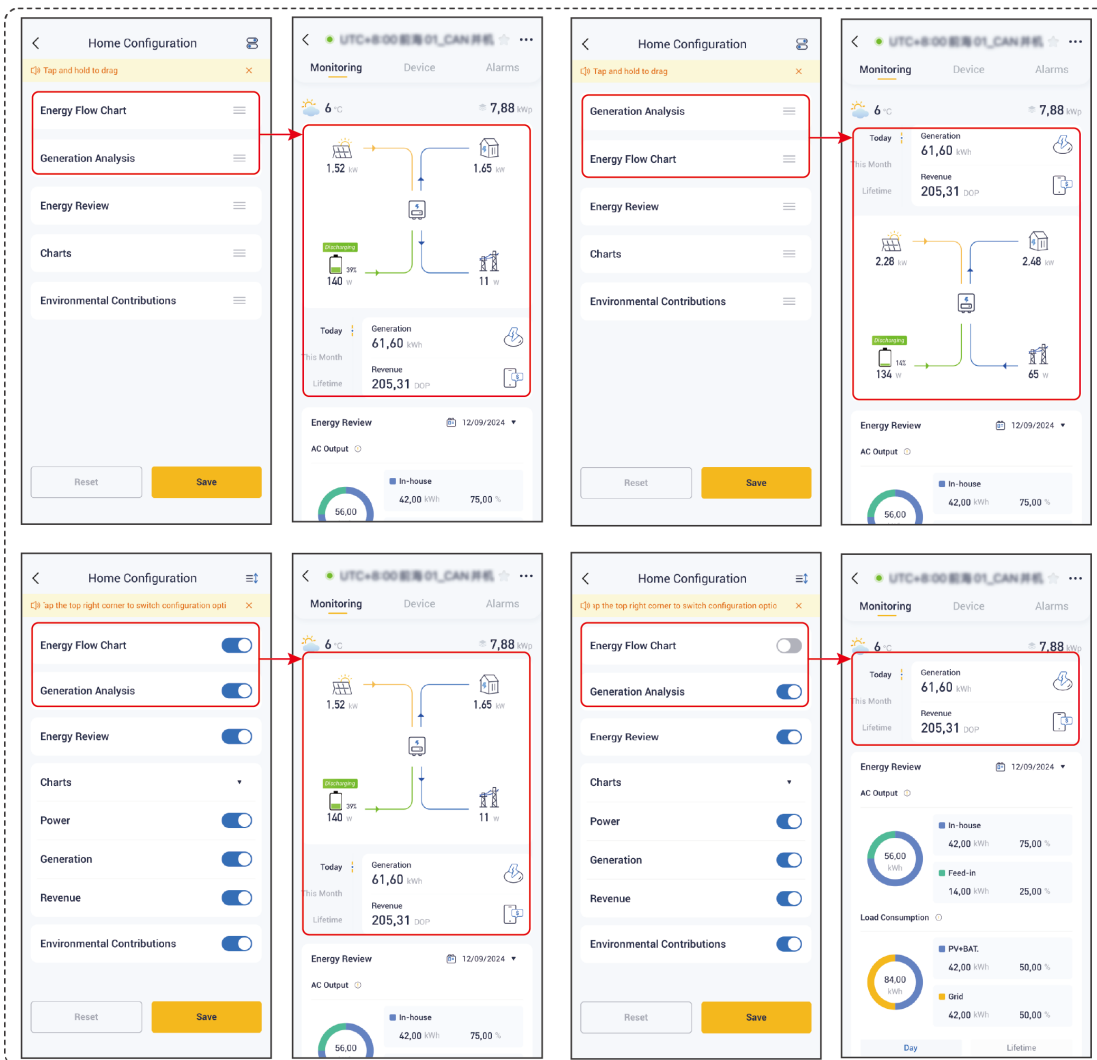
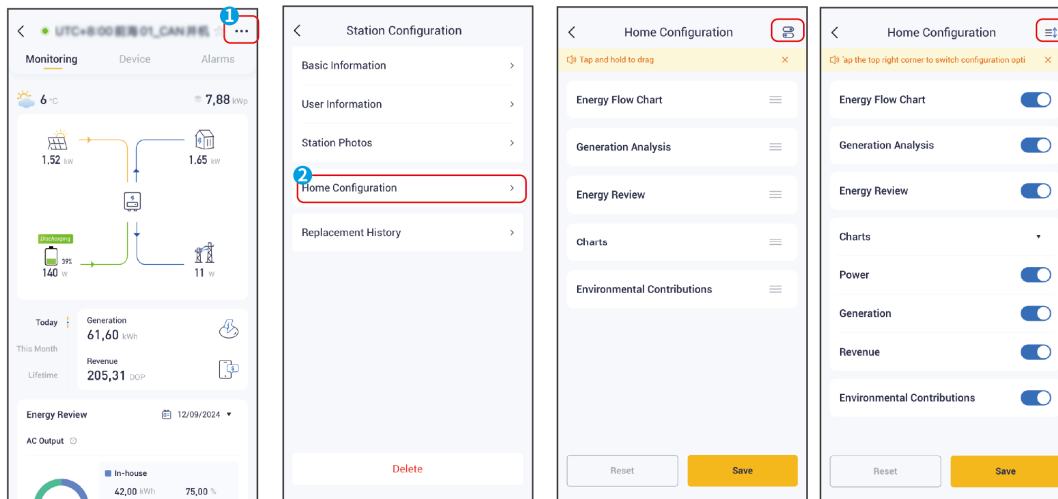

### 10.5.6 Set PV Module Layout

Set the PV Layout Design parameters based on the actual conditions of PV modules.

**Step 1:** (Optional) Select the station to be updated from the station list.

**Step 2:** Tap **☰** > **PV Layout Design** to enter the interface.

**Step 3:** Tap **Row/Column**

,and set the arrangement of modules in each row and each column based on the actual installation of PV modules.

**Step 4:** Tap **Array Name** to enter the **Array Settings** interface, and set the name, angle, and orientation information of the PV array based on the actual situation.

SEMS0056

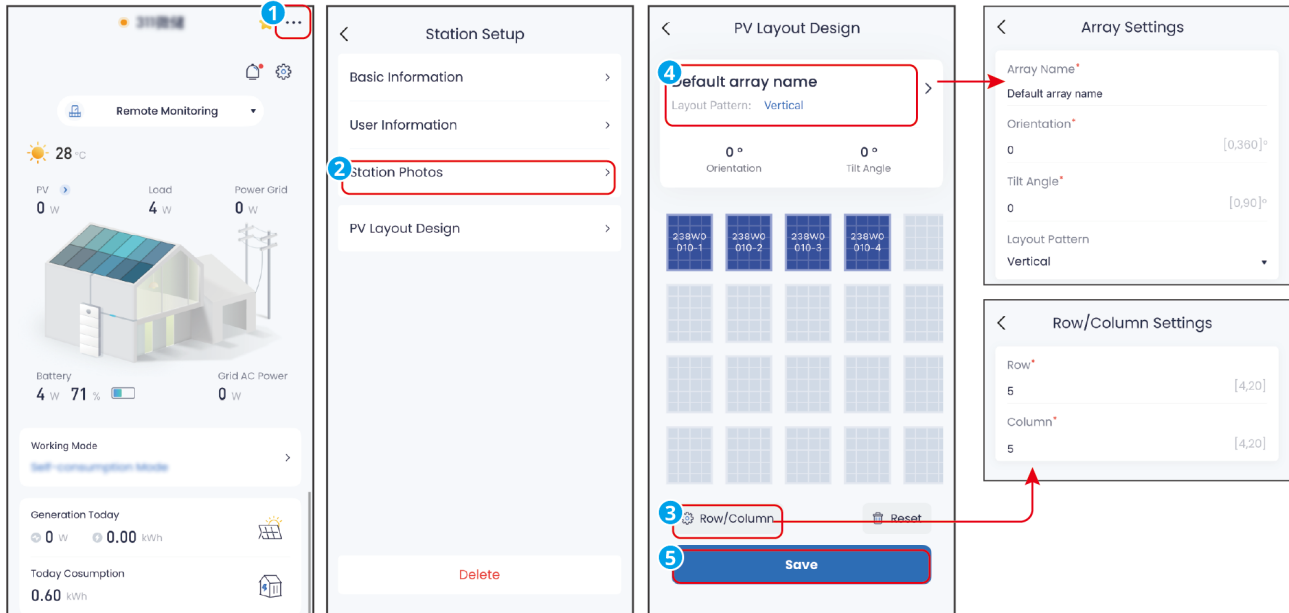

## 10.5.7 Deleting a Station

### NOTICE

For station visitors, deleting a station means unbinding it from their account.

**Step 1:**(Optional) If there are multiple power stations, tap the power station name to enter the power station details page.

**Step 2:**Tap **☰** on the station page.

**Step 3:** Tap **Delete** and **Confirm** to delete the station.

SEMS0016

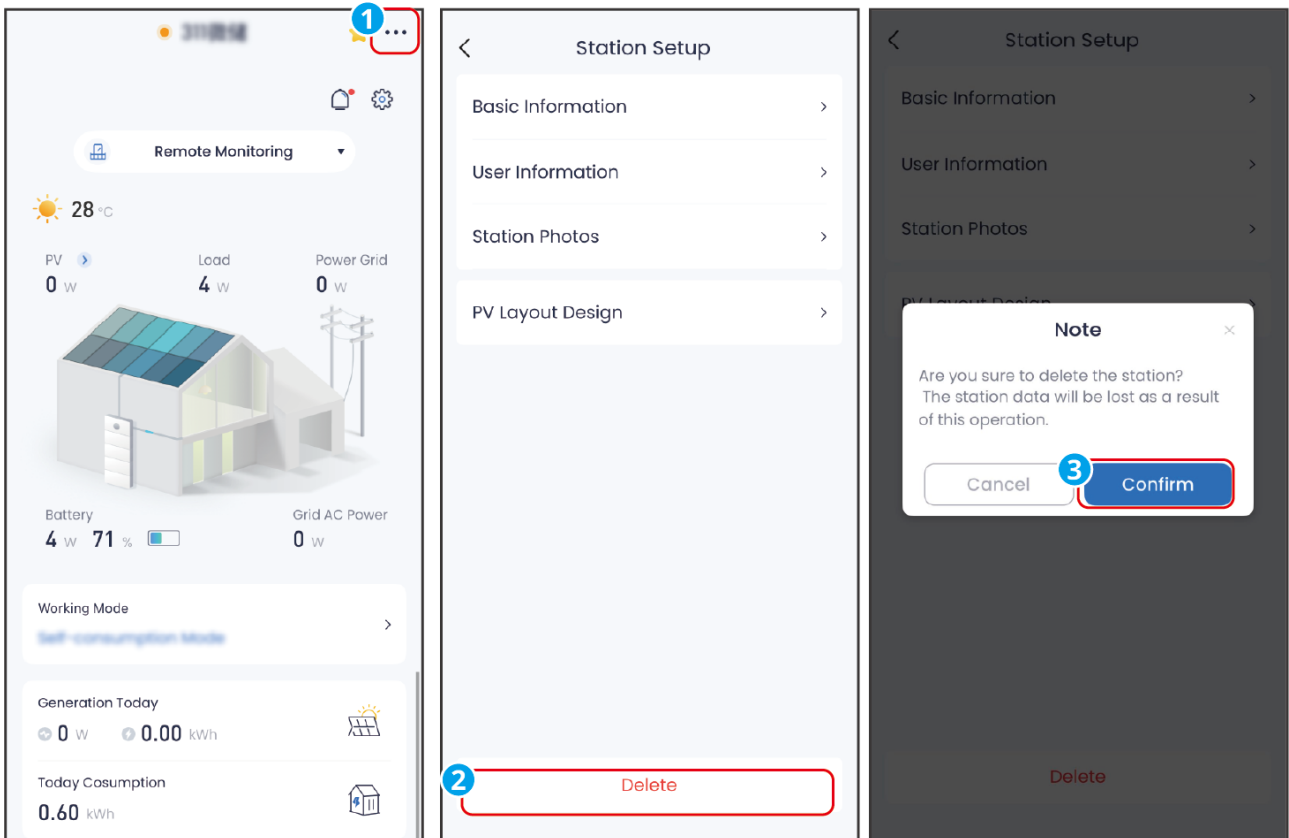

### 10.5.8 Favoriting a Station

To favorite a station, tap the star icon  next to the station name. Tap the icon again to unfavorite it.

Tap  and Select Favorited in the filtering Scope to display all the favorited power stations.

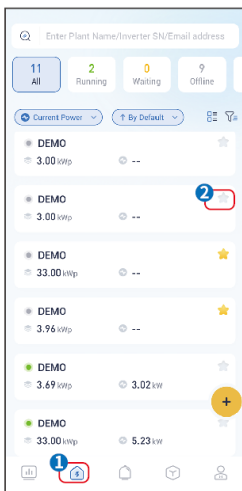

## 10.6 Managing Devices

### 10.6.1 Adding a Device

#### NOTICE

- Supported device types may vary based on the station type.
- If the environmental monitor is connected to a smart logger, add the environmental monitor to the station and view the its data.

**Step 1:** Select a station from the station list.

**Step 2:** Tap **Device** > ⊕ to enter the device addition interface.

**Step 3:** Select the type of device to add.

**Step 4:** Follow the instructions to scan or manually input device information. To add the scanned devices, choose devices from the scanned device list. To manually add a device, scan the device SN code or input required device information. To add multiple devices, repeat the steps as needed.

**Step 5:** When manually adding devices, if you need to add multiple devices, return to the power station details page and repeat steps 3 and 4.

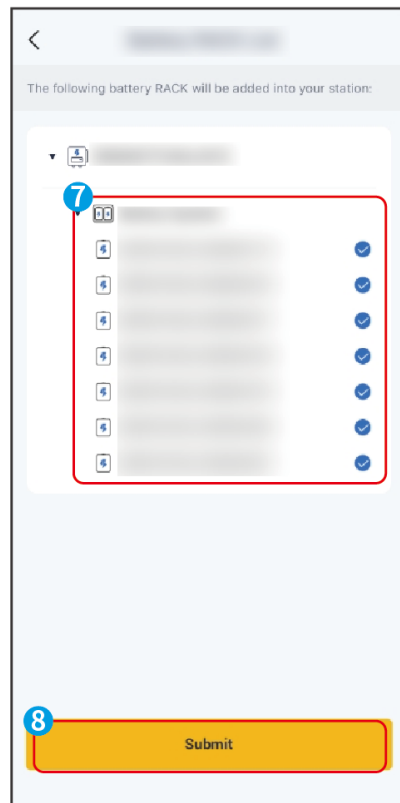
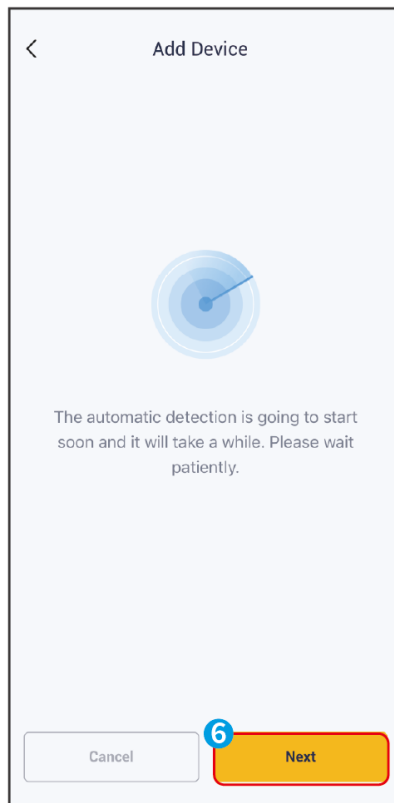
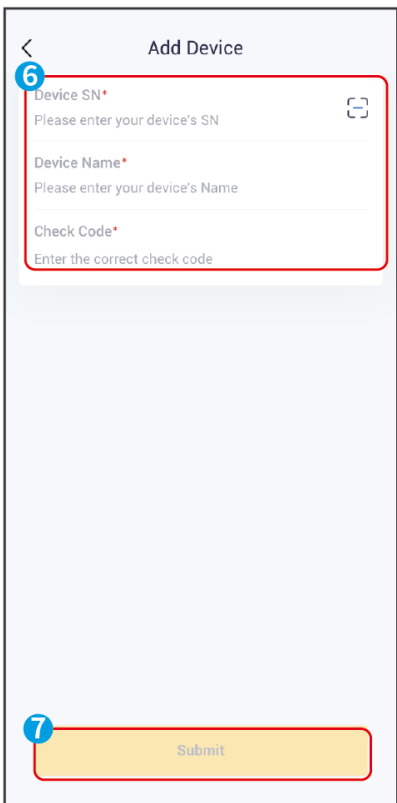
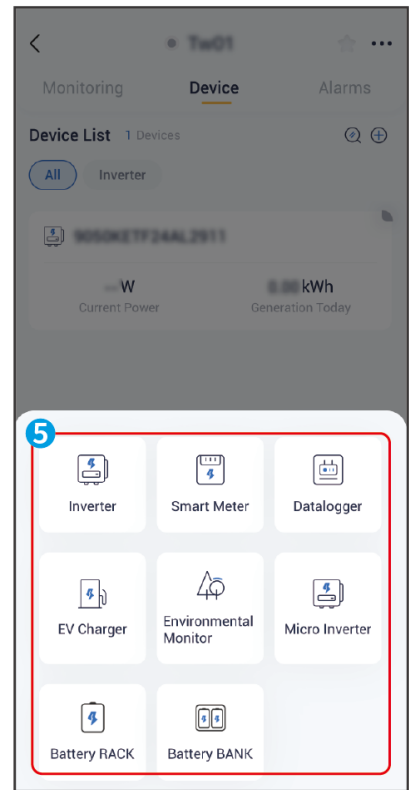
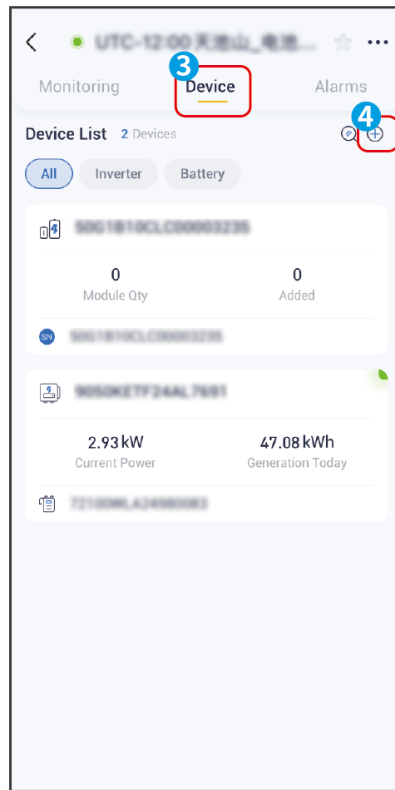
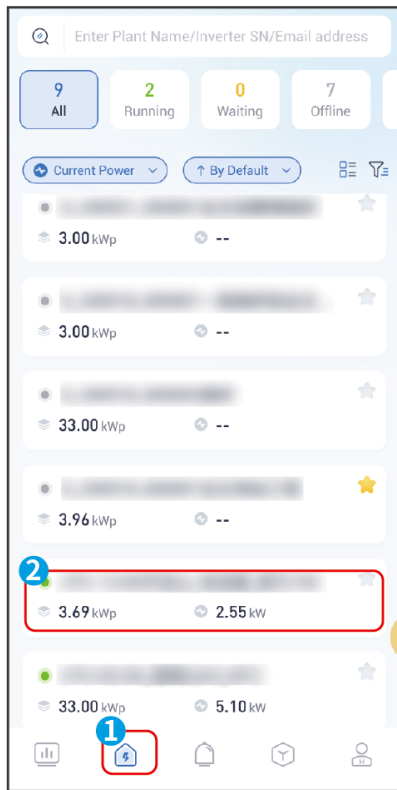

## 10.6.2 Editing Device Information

The device name can be modified.

**Step 1:**(Optional) If there are multiple power stations, tap the power station name to enter the power station details page.

**Step 2:**Tap **Device** to enter the device page. Select the device and swipe left, tap .

**Step 3:** Input new device name and tap **Submit**.

SEMS0027

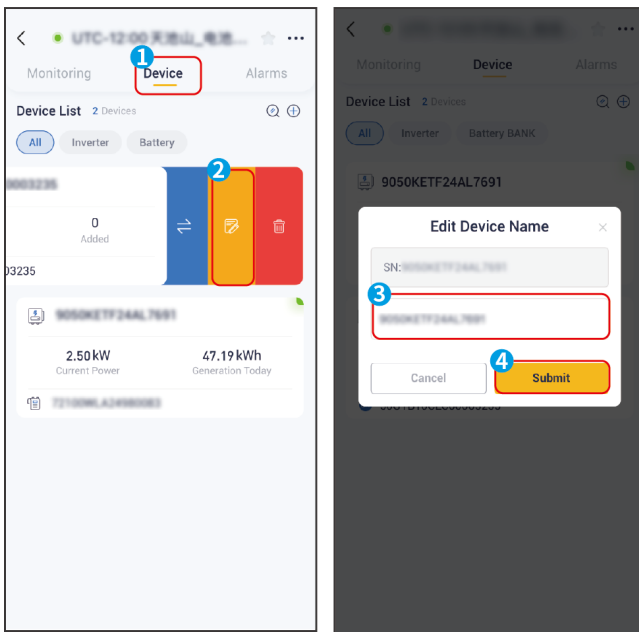

## 10.6.3 Deleting a Device

**Step 1:**(Optional) If there are multiple power stations, tap the power station name to enter the power station details page.

**Step 2:**Tap **Device** to enter the device page. Select the device and swipe left, tap .

**Step 3:** Read the prompt and tap **OK** to delete the device.

SEMS0028

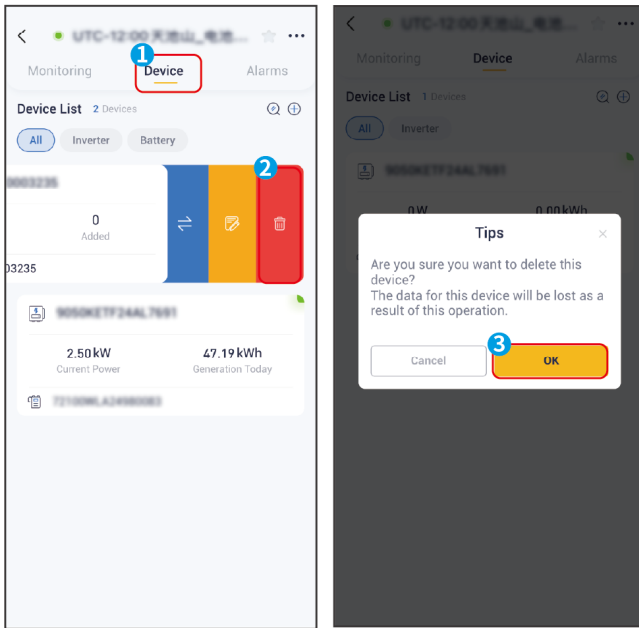

## 10.6.4 Upgrade the Firmware

**Step 1:** (Optional) Select the station to be updated from the station list.

**Step 2:** Tap **Device** to open the device details page and select the device to be upgraded.

**Step 3:** Tap the device serial number to enter the **Firmware Version** page. If the upgrade is available, tap **Upgrade** and follow the instructions. Tap ⌚ to find the upgrade history.

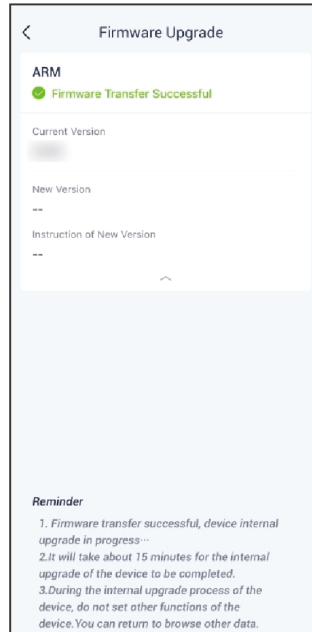
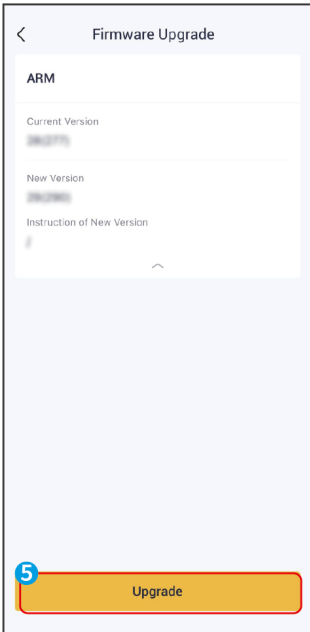
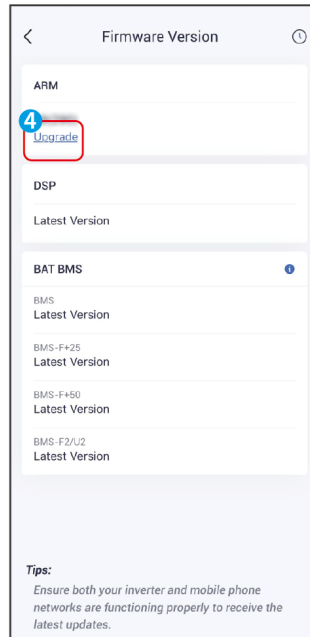
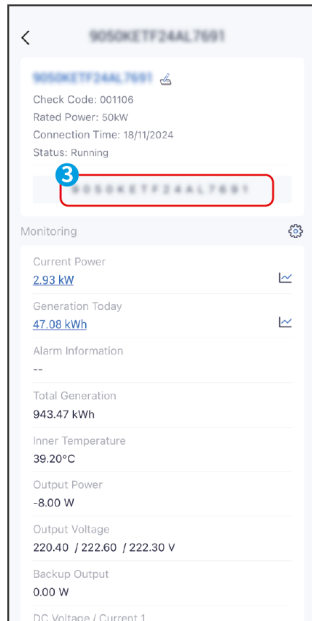
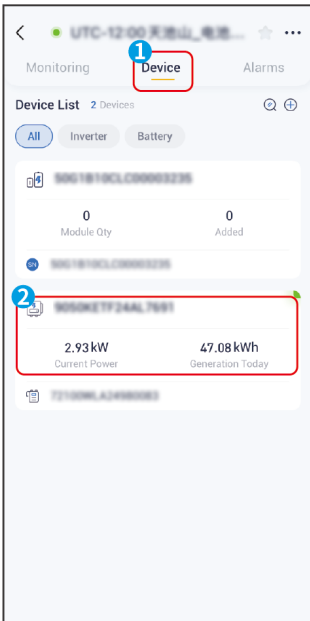

## 10.7 Managing Device Remotely

## NOTICE

- Set the device parameters via SEMS+ App after creating a plant and adding devices to it.
- Before setting any parameters, read through user manual of the App and the inverter or charger to learn the product functions and features. Incorrectly configured parameters, such as grid settings or start/stop commands, may result in devices failing to connect to the grid, potentially affecting power generation.
- λ Only trained professionals familiar with local regulations and electrical systems should perform parameter settings.
- Different account permissions allow for remote setting of different parameters. The interface will be displayed based on the actual account in use, and please refer to the actual interface.
- The setting page varies depending on accounts type and device model.

### 10.7.1 Configuring Hybrid Inverter Parameters

**Step 1:** (Optional) Select the station to be updated from the station list.

**Step 2:** Tap **Device** to enter the device page and choose the device to be configured.

**Step 3:** Tap , read the prompts and set parameters as needed.

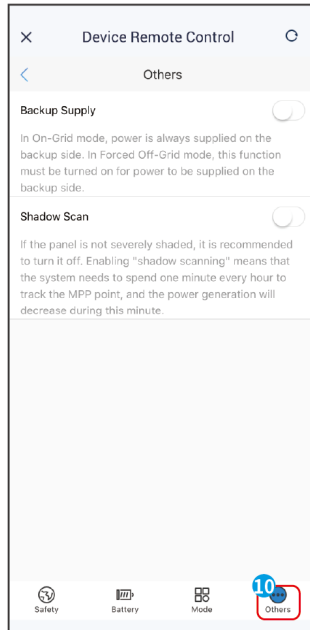
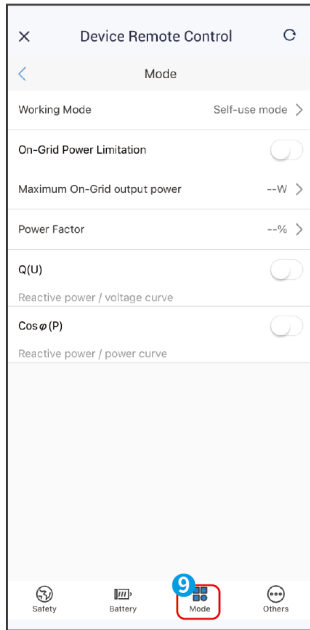
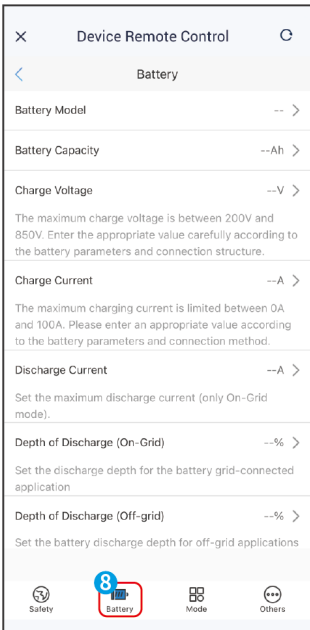
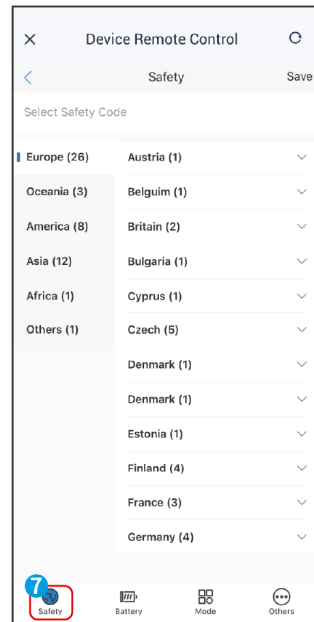
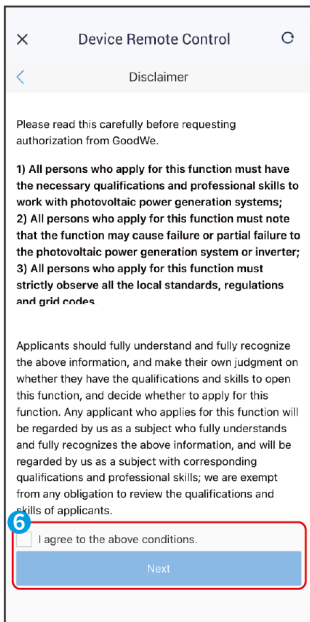
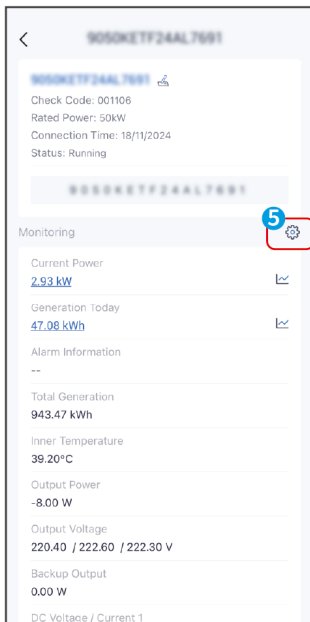
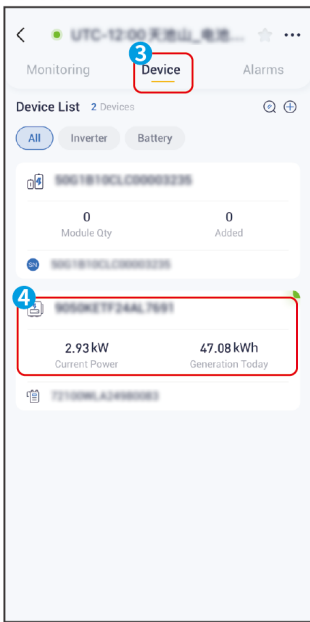

No.	Parameters	Description
1	Safety	Set the safety country in compliance with local grid standards and application scenario of the inverter.
Battery		
2	Battery Model	Set the model of the connected battery.
3	Depth of Discharge (On-Grid)	The maximum depth of discharge of the battery when the system is working on-grid.

No.	Parameters	Description
4	Depth of Discharge (Off-Grid)	The maximum depth of discharge of the battery when the system is working off-grid.
5	Backup SOC Holding	The battery will be charged to preset SOC protection value by utility grid or PV when the system is running on-grid. So that the battery SOC is sufficient to maintain normal working when the system is off-grid.
6	SOC Protection	Start battery protection when the battery capacity is lower than the Depth of Discharge.

No.	Parameters	Description
7	Battery Heating	<p>When a battery with heating function is connected, this option will be displayed on the interface. After enabling the battery heating function, when the battery temperature does not support battery startup, PV power generation or purchased electricity will be used to heat the battery.</p> <p>Heating modes:</p> <ul style="list-style-type: none"> <li>• GW5.1-BAT-D-G20/GW8.3-BAT-D-G20 <ul style="list-style-type: none"> <li>◦ Low-power mode: Maintain the minimum power input capability of the battery. It turns on when the temperature is below -9°C and turns off when the temperature is -7°C or higher.</li> <li>◦ Medium-power mode: Maintain moderate power input capability of the battery. It turns on when the temperature is below 6°C and turns off when the temperature is 8°C or higher.</li> <li>◦ High-power mode: Maintain high power input capability of the battery. It turns on when the temperature is below 11°C and turns off when the temperature is 13°C or higher.</li> </ul> </li> <li>• GW14.3-BAT-LV-G10 <ul style="list-style-type: none"> <li>◦ Low-power mode: Maintain the minimum power input capability of the battery. It turns on when the temperature is below 5°C and turns off when the temperature is 7°C or higher.</li> <li>◦ Medium-power mode: Maintain moderate power input capability of the battery. It turns on when the temperature is below 10°C and turns off when the temperature is 12°C or higher.</li> <li>◦ High-power mode: Maintain high power input capability of the battery. It turns on when the temperature is below 20°C and turns off when the temperature is 22°C or higher.</li> </ul> </li> </ul>
8	Daily Heating Period	Set the battery heating time period based on actual needs.

No.	Parameters	Description
9	Battery Wake-up	After being enabled, the battery can be woken up when it shuts down due to undervoltage protection.
10	Battery Breathing Light	<ul style="list-style-type: none"> <li>• Only applicable to the ESA 3-10kW inverter series. Set the blinking duration of the device's breathing light. Options available: Always on, Always off, 3min.</li> <li>• The default mode is to stay on for three minutes after power-on and then turn off automatically.</li> </ul>
Mode		
11	Working Mode	<p>Set the working mode based on actual needs.</p> <ul style="list-style-type: none"> <li>• Self-use mode: <ul style="list-style-type: none"> <li>◦ Back-up mode: The back-up mode is mainly applied to the scenario where the grid is unstable ;When the grid is disconnected, the inverter turns to off-grid mode and the battery will supply power to the load; when the grid is restored, the inverter switches to on-grid mode.</li> <li>◦ Eco mode: It is recommended to use economic mode in scenarios when the peak-valley electricity price varies a lot. Select Economic mode only when it meets the local laws and regulations. Set the battery to charge mode during Vally period to charge battery with grid power. And set the battery to discharge mode during Peak period to power the load with the battery.</li> </ul> </li> <li>• Smart charging: In some countries/regions, the PV power feed into the utility grid is limited. Select Smart Charging to charge the battery using the surplus power to minimize PV power waste.</li> <li>• Peak shaving mode:Peak shaving mode is mainly applicable to peak power limited scenarios. When the total power consumption of the load exceeds the power consumption quota in a short period of time, battery discharge can be used to reduce the power exceeding the quota.</li> </ul>

No.	Parameters	Description
12	On-Grid Power Limitation	Enable On-Grid Power Limitation when power limiting is required by local grid standards and requirements.
13	Maximum On-Grid Output Power	Set the value based on the actual maximum power feed into the utility grid.
14	Power Factor	Set the power factor based on actual needs.
15	Q(U)	Enable Q(U) Curve when it is required by local grid standards and requirements.
16	COS( $\varphi$ )	Enable Cos $\varphi$ Curve when it is required by local grid standards and requirements.
17	P(F)	Enable P(F) Curve when it is required by local grid standards and requirements.
Others		
18	Backup Supply	After enabling Backup Supply, the battery will power the load connected to the BACK-UP port of the inverter to ensure Uninterrupted Power Supply when the power grid fails.
19	Shadow Scan	Enable Shadow Scan when the PV panels are severely shadowed to optimize the power generation efficiency.

# 11 Maintenance

## 11.1 Power Off the System

### DANGER

- Power off the equipment before operations and maintenance. Otherwise, the equipment may be damaged or electric shocks may occur.
- Delayed discharge. Wait until the components are discharged after power off.
- Push the air switch to restart the battery.
- Strictly follow the power off requirements to avoid damaging the system.

### NOTICE

To ensure effective protection, the cover of the battery system switch should remain closed. Fasten the cover with screws if the switch is not to be used for a long-term period.

### **Power down**

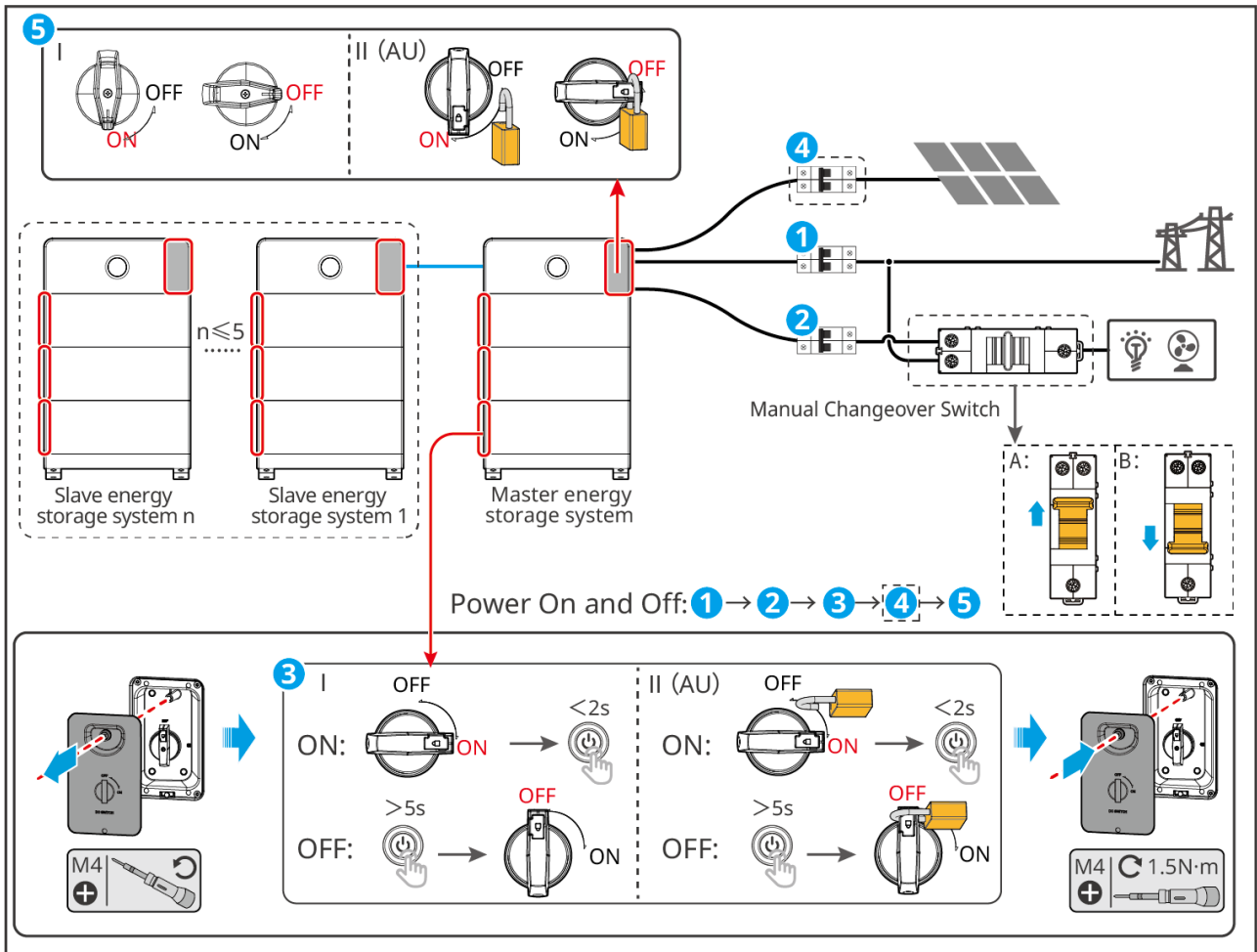

ESA20PWR0002

1. Turn off the ON-GRID circuit breaker.
2. Turn off the BACK-UP circuit breaker.
3. Press and hold any battery multifunction button for 5 seconds to power down the battery system. If the system contains multiple batteries, this operation will power down all batteries simultaneously, eliminating the need for individual operations. Finally, turn the battery system switch to the OFF position.
4. Turn off the DC switch of the inverter. (Optional) Set the manual switch to position A.

## 11.2 Removing the Equipment

 DANGER

- Make sure that the equipment is powered off.
- Wear proper PPE during operations.
- Please use standard disassembly tools when removing wiring terminals to avoid damaging the terminals or equipment.
- Unless otherwise specified, the dismantling process of the equipment is in reverse order to the installation process, and it will not be further elaborated in this document.

1. Power off the System.
2. Label the cables connected in the system with tags indicating the cable type.
3. Disconnect the connecting cables of the inverter, battery, and smart meter in the system, such as DC cables, AC cables, communication cables, and PE cables.
4. Remove equipment such as the smart dongle, inverter, battery, and smart meter.
5. Properly store the equipment and ensure that the storage conditions meet the requirements if it needs to be put into use later.

### 11.3 Disposing of the Equipment

If the equipment cannot work anymore, dispose of it according to the local disposal requirements for electrical equipment waste. The equipment cannot be disposed of together with household waste.

### 11.4 Routine Maintenance

#### WARNING

- Contact after-sales service for help if you find any problems that may influence the battery or the hybrid inverter. Disassemble without permission is strictly forbidden.
- Contact after-sales service for help if the copper conductor is exposed. Do not touch or disassemble privately because high voltage danger exists.
- In case of other emergencies, contact the after-sales service as soon as possible. Operate following the instructions or wait for the after-sales service personnel.

Maintaining Item	Maintaining Method	Maintaining Period	Maintaining Purpose
System Cleaning	Check the heat sink, air intake, and air outlet for foreign matter or dust. Check whether the installation space meets requirements and whether there is any debris around the device.	Once 6 months	Prevent heat dissipation failures.
System installation	Check whether the equipment are installed securely and whether the screws are installed tightly. Check whether the equipment is damaged or deformed.	Once 6-12 months	Ensure that the equipment is installed securely.
Electrical connection	Check whether the cables are securely connected. Check whether the cables are broken or whether there is any exposed copper core.	Once 6-12 months	Confirm the reliability of electrical connections.
Sealing	Check whether all the terminals and ports are properly sealed. Reseal the cable hole if it is not sealed or too big.	Once a year	Confirm that the machine seal and waterproof performance are intact.
Battery maintenance	If the battery is not used for a long time or is not fully charged, it is recommended to charge the battery regularly.	Once/15 days	Protect the battery's lifespan.

## 11.5 Fault

### 11.5.1 Viewing Fault/Alarms Information

All fault and alarm details for the energy storage system are displayed in the **[SolarGo App]** and **[SEMS+ APP]**. If your product malfunctions and you do not see the relevant fault information in the **[SolarGo App]** and **[SEMS+ APP]**, please contact the after-sales service center.

- **SolarGo App**

Through **[Home]** > **[Parameters]** > **[Alarms]**, View the alarm information of the energy storage system.

- **SEMS+ APP**

1. Open the SEMS+ App and log in with any account.
2. All power station fault information can be viewed through the **Power Plant > Alarm**.
3. Click on the specific fault name to view detailed information about the fault: [time of occurrence], [possible cause], and [solution].

### **11.5.2 Fault Information and Troubleshooting**

Perform troubleshooting according to the following methods. Contact the after-sales service if these methods do not work.

Collect the information below before contacting the after-sales service, so that the problems can be solved quickly.

1. Product information like serial number, software version, installation date, fault time, fault frequency, etc.
2. Installation environment, including weather conditions, whether the PV modules are sheltered or shadowed, etc. It is recommended to provide some photos and videos to assist in analyzing the problem.
3. Utility grid situation.

If unlisted problems occur in the system, or if following the instructions does not stop the problem or abnormality, stop operating the system immediately and contact your dealer immediately.

No.	Fault	Solutions/measures to address the issue
1	Unable to search for the wireless signal of the smart dongle.	<ol style="list-style-type: none"> <li>1. Please ensure that no other devices are connected to the smart dongle's wireless signal.</li> <li>2. Please ensure that the SolarGo app has been updated to the latest version.</li> <li>3. Please ensure that the smart dongle is powered on properly, and the blue indicator light is blinking or steady on.</li> <li>4. Ensure that the smart device is within the communication range of the smart dongle.</li> <li>5. Refresh the device list in the app.</li> <li>6. Restart the inverter.</li> </ol>
2	Unable to connect to the wireless signal of the smart dongle.	<ol style="list-style-type: none"> <li>1. Please ensure that no other devices are connected to the smart dongle's wireless signal.</li> <li>2. Restart the inverter or smart dongle, and try to reconnect to the wireless signal of the smart dongle again.</li> <li>3. Ensure successful pairing of Bluetooth.</li> </ol>
3	Cannot find router SSID.	<ol style="list-style-type: none"> <li>1. Put the router nearer to the Smart Dongle. Or add a WiFi relay device to enhance the WiFi signal.</li> <li>2. Reduce the number of devices connected to router.</li> </ol>
4	After completing all configurations, the Smart Dongle fails connecting to the router.	<ol style="list-style-type: none"> <li>1. Restart the inverter.</li> <li>2. Check if the SSID, encryption method and password on WiFi configuration page are the same with that of Router.</li> <li>3. Restart the router.</li> <li>4. Put the router nearer to the Smart Dongle. Or add a WiFi relay device to enhance the WiFi signal.</li> </ol>

No.	Fault	Solutions/measures to address the issue
5	After completing all configurations, the Smart Dongle fails connecting to the router.	Restart the router and the inverter.

### 11.5.2.1 Inverterfault

No.	fault name	fault cause	Troubleshooting recommendation
1	Grid disconnected/Grid Power Outage	<ol style="list-style-type: none"> <li>1. Utility grid power outage.</li> <li>2. AC line or AC Switch disconnected.</li> </ol>	<ol style="list-style-type: none"> <li>1. The alarm automatically disappears after Grid connected recovery.</li> <li>2. Check if the AC line or AC Switch is disconnected.</li> </ol>
2	Utility grid overvoltage Protection/Grid Overvoltage	Utility gridvoltage exceeds the allowable range, or the high voltage duration surpasses the high voltage ride-through setting.	<ol style="list-style-type: none"> <li>1. If it occurs occasionally, it may be due to a temporary abnormality in Utility grid. Inverter will resume normal operation after detecting that Utility grid is functioning properly, without requiring manual intervention.</li> <li>2. If it occurs frequently, check whether Utility gridvoltage is within the allowable range.</li> </ol> <ul style="list-style-type: none"> <li>• If Utility gridvoltage exceeds the permissible range, please contact the</li> </ul>

No.	fault name	fault cause	Troubleshooting recommendation
			<p>local power operator.</p> <ul style="list-style-type: none"> <li>• If the Utility gridvoltage is within the allowable range, it is necessary to modify the InverterUtility grid overvoltage Protection point after obtaining consent from the local power operator.HVRTenable or disable the Utility grid overvoltage Protection function.</li> </ul> <p>3. If the issue persists for an extended period, please check whether the breaker on the AC side and the output cables are properly connected.</p>

No.	fault name	fault cause	Troubleshooting recommendation
3	Utility grid Undervoltage Protection/Grid Undervoltage	Utility gridvoltage is below the permissible range, or the duration of low voltage exceeds the low voltage ride-through setting.	<p>1. If it occurs occasionally, it may be due to a temporary abnormality in Utility grid. Inverter will resume normal operation after detecting that Utility grid is normal, without requiring manual intervention.</p> <p>2. If it occurs frequently, check whether the Utility gridvoltage is within the allowable range.</p> <ul style="list-style-type: none"> <li>• If Utility gridvoltage exceeds the permissible range, please contact the local power operator.</li> <li>• If the Utility gridvoltage is within the allowable range, it is necessary to modify the InverterUtility grid undervoltage Protection point after obtaining consent from the local power operator.LVRTEnable or disable the Utility grid under-voltage Protection function.</li> </ul> <p>3. If the issue persists for an extended period, please check whether the breaker on the AC side and the output cables are properly connected.</p>

No.	fault name	fault cause	Troubleshooting recommendation
4	Overvoltage rapid Protection/Grid Rapid Overvoltage	Utility gridvoltage detection shows abnormality or ultra-high voltage triggers fault.	<p>1. If it occurs occasionally, it may be due to a temporary abnormality in Utility grid. Inverter will resume normal operation after detecting that Utility grid is functioning properly, without requiring manual intervention.</p> <p>2. If it occurs frequently, check whether Utility gridvoltage is within the allowable range.</p> <ul style="list-style-type: none"> <li>• If Utility gridvoltage exceeds the permissible range, please contact the local power operator.</li> <li>• If the Utility gridvoltage is within the allowable range, it is necessary to modify the InverterUtility grid undervoltage Protection point after obtaining consent from the local power operator.LVRTEnable or disable the Utility grid under-voltage Protection function.</li> </ul> <p>3. If the issue persists for an extended period, please check whether the AC-side breaker and output cables are properly connected.</p>

No.	fault name	fault cause	Troubleshooting recommendation
5	10minOvervoltage Protection/Grid 10min Overvoltage	In10minThe sliding average of Utility gridvoltage exceeds the safety regulation limits.	<p>1. If it occurs occasionally, it may be due to a temporary anomaly in Utility grid. Inverter will resume normal operation upon detecting that Utility grid is functioning properly, without requiring manual intervention.</p> <p>2. Check if Utility gridvoltage is operating at a high voltage for an extended period. If this occurs frequently, verify whether Utility gridvoltage is within the permissible range.</p> <ul style="list-style-type: none"> <li>• If Utility gridvoltage exceeds the permissible range, please contact the local power operator.</li> <li>• If the Utility gridvoltage is within the allowable range, it is necessary to obtain approval from the local power operator before modifying the Utility grid.</li> </ul> <p>10minOvervoltage Protection point.</p>

No.	fault name	fault cause	Troubleshooting recommendation
6	overfrequency/Grid Overfrequency	Utility grid anomaly: Utility grid actual Frequency exceeds local Utility grid standard requirements.	<p>1. If it occurs occasionally, it may be due to a temporary abnormality in Utility grid. Inverter will resume normal operation after detecting that Utility grid is functioning properly, without requiring manual intervention.</p> <p>2. If it occurs frequently, check whether Utility grid Frequency is within the allowable range.</p> <ul style="list-style-type: none"> <li>• If the Utility gridFrequency exceeds the permissible range, please contact the local power operator.</li> <li>• If the Utility gridFrequency is within the allowable range, it is necessary to modify the Utility grid over-frequency Protection point after obtaining consent from the local power operator.</li> </ul>

No.	fault name	fault cause	Troubleshooting recommendation
7	underfrequency/Grid Underfrequency	Utility grid anomaly: Utility grid actual Frequency is lower than local Utility grid standard requirement.	<p>1. If it occurs occasionally, it may be due to a temporary abnormality in Utility grid. Inverter will resume normal operation after detecting that Utility grid is functioning properly, without requiring manual intervention.</p> <p>2. If it occurs frequently, please check whether Utility grid and Frequency are within the allowable range.</p> <ul style="list-style-type: none"> <li>• If Utility gridFrequency exceeds the permissible range, please contact the local power operator.</li> <li>• If the Utility gridFrequency is within the allowable range, it is necessary to modify the Utility grid over-frequency Protection point after obtaining consent from the local power operator.</li> </ul>

No.	fault name	fault cause	Troubleshooting recommendation
8	frequency shift/Grid Frequency Unstable	Utility grid anomaly: The actual Frequency variation rate does not comply with the local Utility grid standard.	<p>1. If it occurs occasionally, it may be due to a temporary abnormality in Utility grid. Inverter will resume normal operation after detecting that Utility grid is functioning properly, without requiring manual intervention.</p> <p>2. If it occurs frequently, check whether Utility grid and Frequency are within the allowable range.</p> <ul style="list-style-type: none"> <li>• If the Utility grid Frequency exceeds the permissible range, please contact the local power operator.</li> <li>• If the Utility grid Frequency is within the allowable range, please contact your dealer or after-sales service center.</li> </ul>

No.	fault name	fault cause	Troubleshooting recommendation
9	Utility grid phase shift Protection/Grid Phase Unstable	Utility grid anomaly: Utility grid voltage phase change rate does not comply with local Utility grid standard.	<p>1. If it occurs occasionally, it may be due to a temporary abnormality in Utility grid. Inverter will resume normal operation after detecting that Utility grid is functioning properly, without requiring manual intervention.</p> <p>2. If it occurs frequently, check whether the Utility grid Frequency is within the allowable range.</p> <ul style="list-style-type: none"> <li>• If Utility gridFrequency exceeds the permissible range, please contact the local power operator.</li> <li>• If Utility gridFrequency is within the allowable range, please contact your dealer or after-sales service center.</li> </ul>

No.	fault name	fault cause	Troubleshooting recommendation
10	Islanding/Anti-islanding Protection	Utility grid has been disconnected, maintaining Utility grid voltage due to the presence of load. According to safety regulation Protection, on-grid has been stopped.	<p>1. If it occurs occasionally, it may be due to a temporary abnormality in Utility grid. Inverter will resume normal operation after detecting that Utility grid is functioning properly, without requiring manual intervention.</p> <p>2. If it occurs frequently, check whether Utility gridFrequency is within the allowable range.</p> <ul style="list-style-type: none"> <li>• If Utility gridFrequency exceeds the allowable range, please contact the local power operator.</li> <li>• If Utility gridFrequency is within the allowable range, please contact your dealer or after-sales service center.</li> </ul>
11	ride-through undervoltage/LVRT Undervoltage	Utility grid anomaly: Utility gridvoltage anomaly duration exceeds the specified high-low transition time.	

No.	fault name	fault cause	Troubleshooting recommendation
12	ride-through overvoltage/HVRT Overvoltage	Utility grid anomaly: Utility gridvoltage anomaly duration exceeds the specified high-low transition time.	<p>1. If it occurs occasionally, it may be due to a temporary abnormality in Utility grid. Inverter will resume normal operation after detecting that Utility grid is normal, without requiring manual intervention.</p> <p>2. If it occurs frequently, please check whether Utility grid, voltage, and Frequency are within the allowable range and stable. If not, please contact the local power operator; if yes, please contact your dealer or after-sales service center.</p>
13	Waveform detection anomaly/Grid Waveform Abnormal	Utility grid anomaly: Utility gridvoltage detection triggered fault due to abnormality.	
14	Utility grid Phase Loss Protection Grid Phase Loss	Utility grid anomaly: Utility gridvoltage has a single-phase dip.	

No.	fault name	fault cause	Troubleshooting recommendation
15	Utility gridvoltage imbalance/Grid Voltage Imbalance	Phase Utility grid has excessive deviation from voltage.	<p>1. If it occurs occasionally, it may be due to a temporary abnormality in Utility grid. Inverter will resume normal operation after detecting that Utility grid is normal, without requiring manual intervention.</p> <p>2. If it occurs frequently, please check whether Utility grid, voltage, and Frequency are within the allowable range and stable. If not, please contact the local power operator; if yes, please contact your dealer or after-sales service center.</p>
16	Utility grid phase fault/Grid Phase Sequence Abnormal	Inverter and Utility grid wiring abnormality: wiring not in positive sequence	<p>1. Check whether the wiring of Inverter and Utility grid is in positive sequence. After the wiring is corrected (e.g., by swapping any two live wires), fault will automatically disappear.</p> <p>2. If the fault persists after correct wiring, please contact the distributor or GoodWe Customer Service Center.</p>
17	Grid disconnected rapid Protection/Grid Rapid Shutdown Protection	Quickly shut down the output upon detecting the Grid disconnected operating condition.	<p>1. Grid connected automatically disappears after fault is restored</p>

No.	fault name	fault cause	Troubleshooting recommendation
18	Utility grid Neutral Line LossSplitUtility grid/Neutral Line Loss(Split Grid)	Phase separation Utility grid neutral line loss	1. The alarm automatically disappears after Grid connected recovery. 2. Check if the AC line or AC Switch is disconnected.
19	EMS/Forced off-grid	EMSIssue forced off-grid command, but the off-grid function is not enabled.	Enable off-grid function
20	Passive Islanding Detection/Passive Anti-islanding Protection	-	-
21	Grid type Error/Grid Type Abnormal	Actual Grid type (two-phase or split-phase) does not match the set safety regulations.	Switch the corresponding safety regulations according to the actual Grid type.
22	30mAGfciProtection/ GFCI Protection (30mA)	During operation, the input-to-ground insulation resistance becomes low.	1. If it occurs occasionally, it may be caused by temporary abnormalities in the external circuit. It will return to normal operation after fault is cleared, without requiring manual intervention. 2. If it occurs frequently or cannot be restored for a long time, please check whether the PV String ground impedance is too low.

No.	fault name	fault cause	Troubleshooting recommendation
23	60mAGfciProtection/ GFCI Protection (60mA)	During operation, the input-to-ground insulation resistance becomes low.	<p>1. If it occurs occasionally, it may be caused by temporary abnormalities in the external circuit. It will return to normal operation after fault is cleared, without requiring manual intervention.</p> <p>2. If the issue occurs frequently or persists for an extended period, check whether the PV String ground impedance is too low.</p>
24	150mAGfciProtection/ GFCI Protection (150mA)	During operation, the input-to-ground insulation resistance becomes lower.	<p>1. If it occurs occasionally, it may be caused by temporary abnormalities in the external circuit. It will return to normal operation after fault is cleared, without requiring manual intervention.</p> <p>2. If the issue occurs frequently or cannot be resolved for an extended period, please check whether the PV String ground impedance is too low.</p>

No.	fault name	fault cause	Troubleshooting recommendation
25	Gfcigradual Protection/GFCI Protection (300mA)	During operation, the input-to-ground insulation resistance becomes low.	<ol style="list-style-type: none"> <li>1. If it occurs occasionally, it may be caused by temporary abnormalities in the external circuit. The system will resume normal operation after fault is cleared, without requiring manual intervention.</li> <li>2. If the issue occurs frequently or cannot be resolved for an extended period, please check whether the PV String ground impedance is too low.</li> </ol>
26	DCIPrimary Protection/DCI Protection Level 1	The DC component of the inverter output current exceeds the safety regulations or the default allowable range of the machine.	<ol style="list-style-type: none"> <li>1. If the abnormality is caused by an external fault, the Inverter will automatically resume normal operation after the fault disappears, without requiring manual intervention.</li> <li>2. If this alarm occurs frequently and affects the normal power generation of the power station, please contact the dealer or GoodWe after-sales service center.</li> </ol>

No.	fault name	fault cause	Troubleshooting recommendation
27	DCIsecondary Protection/DCI Protection Level 2	The DC component of the inverter output current exceeds the safety regulations or the default allowable range of the machine.	<ol style="list-style-type: none"> <li>1. If the abnormality is caused by an external fault, the Inverter will automatically resume normal operation after the fault disappears, without requiring manual intervention.</li> <li>2. If this alarm occurs frequently and affects the normal power generation of the power station, please contact the dealer or GoodWe after-sales service center.</li> </ol>
28	low/Low Insulation Resistance	<ol style="list-style-type: none"> <li>1. PV String is short-circuited to ground with Protection.</li> <li>2. The environment of PV StringInstallation is consistently humid, and the line-to-ground insulation is poor.</li> <li>3. Batteryport line-to-ground insulation resistance is low.</li> </ol>	<ol style="list-style-type: none"> <li>1. Check the impedance between PV String/Battery port and ground Protection. A resistance greater than 50kΩ is normal. If the measured resistance is less than 50kΩ, locate and rectify the short circuit point.</li> <li>2. Check if the Inverter's PE cable is properly connected.</li> <li>3. If it is confirmed that the impedance is indeed lower than the default value in rainy weather conditions, please reset the Inverter "insulation resistanceProtection point" via the SolarGo App.</li> </ol>

No.	fault name	fault cause	Troubleshooting recommendation
			<p>In the Australian and New Zealand markets, when insulation resistance fault occurs, the following methods can also be used for alarm: Inverter.</p> <ol style="list-style-type: none"> <li>1. Inverter is equipped with a buzzer, which will sound continuously for 1 minute when a fault occurs; if the fault is not resolved, the buzzer will sound again every 30 minutes.</li> <li>2. If Inverter is added to the monitoring platform and the alarm notification method is configured, the alarm information can be sent to customers via email.</li> </ol>
29	System Grounding Anomaly/Grounding Abnormal	<ol style="list-style-type: none"> <li>1. The PE cable of Inverter is not connected.</li> <li>2. When the output of PV String is grounded, the output side of Inverter is not connected to an isolation transformer.</li> </ol>	<ol style="list-style-type: none"> <li>1. Please confirm whether the Inverter of PE cable is not properly connected.</li> <li>2. In the scenario where the output of PV String is grounded, please confirm whether the output side of Inverter is connected to an isolation transformer.</li> </ol>

No.	fault name	fault cause	Troubleshooting recommendation
30	Live wire to ground short circuit/L-PE Short Circuit	Output phase line to PE Low impedance or short circuit	Detect output phase line pair PE Impedance, find out Locations with low impedance and repair them.
31	DCV Primary Protection/DCV Protection Level 1	Abnormal load fluctuation	<ol style="list-style-type: none"> <li>1. If the abnormality is caused by an external fault, the Inverter will automatically resume normal operation after the fault disappears, without requiring manual intervention.</li> <li>2. If this alarm occurs frequently and affects the normal power generation of the power station, please contact the distributor or GoodWe after-sales service center.</li> </ol>

No.	fault name	fault cause	Troubleshooting recommendation
32	DCVsecondary Protection/DCV Protection Level 2	Abnormal load fluctuation	<p>1. If the abnormality is caused by an external fault, the Inverter will automatically resume normal operation after the fault disappears, without requiring manual intervention.</p> <p>2. If this alarm occurs frequently and affects the normal power generation of the power station, please contact the dealer or GoodWe after-sales service center.</p>
33	Hardware power limit Protection/Hard Export Limit Protection	Abnormal load fluctuation	<p>1. If the abnormality is caused by an external fault, the Inverter will automatically resume normal operation after the fault disappears, without requiring manual intervention.</p> <p>2. If this alarm occurs frequently and affects the normal power generation of the power station, please contact the distributor or GoodWe after-sales service center.</p>

No.	fault name	fault cause	Troubleshooting recommendation
34	Internal communication link failure/Internal Comm Loss	Reference specific subcode reason	Disconnect the AC output side switch and DC input side switch,5 After a few minutes, close the AC output side switch and the DC input side switch. If fault persists, please contact the dealer or GoodWe after-sales service center.
35	Leakage currentGFCIMultiple fault shutdowns/Multiple GFCI Failures	North American safety regulations require that after multiple fault, the system must not recover automatically and requires manual intervention or waiting.24hPost-recovery	1. Please check if the PV String ground impedance is too low.
36	DC combiner boxAFCIMultiple fault shutdowns/Multiple AFCI Failures	North American safety regulations require that after multiple fault, it cannot automatically recover and must be manually restored or wait.24hPost-recovery	1. After the machine is reconnected, check if the voltage current of each circuit is abnormally reduced to zero. 2. Check if the DC-side terminal is securely connected.

No.	fault name	fault cause	Troubleshooting recommendation
37	External communication link failure/External Comm Loss	Inverter external device communication lost, possibly due to peripheral power supply issues, Communication Protocols mismatch, or unconfigured corresponding peripherals.	Judgment is made based on the actual model and detection enable bits; peripherals not supported by certain models will not be detected.
38	Back-upport overload fault/Back-up Output Overload	1. Prevent Inverter from continuous overload output.	1. Disconnect some off-grid loads to reduce the off-grid output Power of Inverter.
39	Back-upport overvoltage fault/Back-up Output Overvoltage	2. Prevent damage to the load caused by Inverter output overvoltage.	1. If it occurs occasionally, it may be caused by load switching and does not require manual intervention. 2. If it occurs frequently, please contact the dealer or GoodWe after-sales service center.

No.	fault name	fault cause	Troubleshooting recommendation
40	Synchronization timeout in on-grid fault On-grid PWM Sync Fault	Abnormal occurrence in carrier synchronization on-grid	<p>1 Check if the synchronization line connection is normal.</p> <p>2 Check if the master-slave settings are normal.</p> <p>3 Disconnect the AC output side switch and the DC input side switch.</p> <p>5 After a few minutes, close the AC output side switch and the DC input side switch. If fault persists, please contact the dealer or GoodWe after-sales service center.</p>
41	External connection Box fault/External Box Failure	Waiting for grid disconnection Box Excessive relay switching time	<p>1. Inspection Box Is it functioning properly;</p> <p>2. Inspection Box Is the communication wiring correct;</p>

No.	fault name	fault cause	Troubleshooting recommendation
42	Generator fault/Generator Failure	<p>1. This fault will always be displayed when the generator is not connected.</p> <p>2. During generator operation, failure to meet generator safety regulations will trigger this fault.</p>	<p>1. When the generator is not connected, ignore this fault;</p> <p>2. This fault is normal when the generator experiences fault. After the generator recovers, wait for a period of time, and the fault will automatically clear.</p> <p>3. The fault will not affect the normal operation of the off-grid mode.</p> <p>4. The generator and Utility grid are connected simultaneously and meet safety requirements. Utility grid takes priority for on-grid and will operate in the Utility grid on-grid state.</p>
43	External connectionSTSfault/External STS Failure	Inverter andSTSAbnormal connection cable	Check Inverter andSTSIs the wiring sequence of the harness connections one-to-one and sequentially corresponding?
44	CTMissing fault/CT Loss	CTConnection wire disconnected (Japanese safety regulation requirement)	InspectionCTIs the wiring correct.

No.	fault name	fault cause	Troubleshooting recommendation
45	power limit fault/Export Limit Protection	1. Grid disconnection due to Inverter alarm 2. meter Unstable communication 3. Reverse power flow condition occurs	1. Check if there are any other error messages in Inverter. If so, perform targeted troubleshooting. 2. Inspection meter Is the connection reliable? 3. If this alarm occurs frequently and affects the normal power generation of the power station, please contact the distributor or GoodWe after-sales service center.
46	Bypass overload/Bypass Over Load	-	-
47	Black Start Failure	-	-
48	Parallel operation IO Self-check abnormality/Parallel I/O Check Abnormal	Parallel communication cable is not securely connected or parallel operation issue. IO Chip damage	Check if the parallel communication cable is securely connected, and then recheck. IO Is the chip damaged? If yes, replace it. IO Chip.
49	Parallel operation CAN Communication anomaly/Parallel CAN Comm Abnormal	Parallel communication cable is not securely connected or some units are offline.	Check whether all machines are power on and if the parallel communication cables are securely connected.
50	Parallel connection Utility grid reversed polarity /Parallel Grid Line Reversed	Some machines have the Utility grid line reversed with other connections.	Reconnect the Utility grid line.

No.	fault name	fault cause	Troubleshooting recommendation
51	Parallel operation Back-up Reverse connection/Paralell Back-up Line Reversed	Partial machines backup Line and other connections reversed	reconnection backup Line.
52	Inverter soft start failure/Inverter Soft Start Failure	Inverter soft start failure during off-grid cold start	Check whether the inverter module of the machine is damaged.
53	Off-grid output instantaneous overvoltage fault/Off grid AC Ins Volt High	-	-
54	AC sensor self-check abnormality/AC HCT Check Abnormal	AC sensor sampling anomaly detected	Disconnect the AC output side switch and DC input side switch,5 After a few minutes, close the AC output side switch and the DC input side switch. If fault persists, please contact the dealer or GoodWe after-sales service center.
55	AC Sensor fault/AC HCT Failure	HCT Sensor abnormality detected	Disconnect the AC output side switch and DC input side switch,5 After a few minutes, close the AC output side switch and the DC input side switch. If fault persists, please contact the dealer or GoodWe after-sales service center.

No.	fault name	fault cause	Troubleshooting recommendation
56	Leakage current sensor self-check abnormal/GFCI HCT Check Abnormal	Leakage current sensor sampling anomaly detected.	Disconnect the AC output side switch and DC input side switch,5 After a few minutes, close the AC output side switch and the DC input side switch. If fault persists, please contact the dealer or GoodWe after-sales service center.
57	Leakage current sensor/GFCI HCT Failure	Leakage current sensor is abnormal	Disconnect the AC output side switch and DC input side switch,5 After a few minutes, close the AC output side switch and the DC input side switch. If fault persists, please contact the dealer or GoodWe after-sales service center.
58	Relay self-check abnormality/Relay Check Abnormal	Relay abnormality, cause: 1Relay abnormality (relay short circuit) 2Relay sampling circuit abnormality. 3Abnormal AC measurement wiring (possible loose connection or short circuit)	Disconnect the AC output side switch and DC input side switch,5 After a few minutes, close the AC output side switch and the DC input side switch. If fault persists, please contact the dealer or GoodWe after-sales service center.

No.	fault name	fault cause	Troubleshooting recommendation
59	Relay/Relay Failure	1Relay abnormality (relay short circuit) 2Relay sampling circuit abnormality. 3Abnormal AC side wiring (possible loose connection or short circuit)	Disconnect the AC output side switch and DC input side switch,5 After a few minutes, close the AC output side switch and the DC input side switch. If fault persists, please contact the dealer or GoodWe after-sales service center.
60	DC combiner box (string)17~32)/AFCI Failure (String 17~32)	1DC side connection terminal loose; 2DC side connection terminal loose contact; 3Core damage and poor contact	1After the machine is reconnected, check whether the voltage current of each circuit is abnormally reduced to zero. 2Check if the DC side terminal is securely connected.
61	DC combiner box (string combiner)33~48)/AFC I Failure (String 33~48)	1DC side connection terminal loose; 2DC side connection terminal loose contact; 3Core damage and poor contact	1After the machine is on-grid, check whether the voltage current of each circuit is abnormally reduced to zero. 2Check if the DC-side terminal is securely connected.
62	FlashRead/Write Error/Flash R/W Abnormal	Possible causes: flashContent has changed;flashEnd of life	1. Upgrade to the latest version of the program 2. Contact the distributor or GoodWe after-sales service center.

No.	fault name	fault cause	Troubleshooting recommendation
63	DC arc fault (string)1~16)/AFCI Failure (String 1~16)	1DC side connection terminal loose; 2DC side connection terminal loose contact; 3Core damage and poor contact	1After the machine is reconnected, check whether the voltage current of each circuit is abnormally reduced to zero. 2Check if the DC side terminal is securely connected.
64	DC arc self-check fault/AFCI Check Failure	During the arc self-check process, the arc module failed to detect the arc fault.	Disconnect the AC output side switch and DC input side switch,5 After a few minutes, close the AC output side switch and the DC input side switch. If fault persists, please contact the dealer or GoodWe after-sales service center.
65	AC terminal temperature too high/AC Terminal Overtemperature	AC terminal temperature too high, possible causes: 1Inverter Installation Location not ventilated. 2Ambient temperature is too high. 3Internal fan operation abnormal.	

No.	fault name	fault cause	Troubleshooting recommendation
66	Cavity temperature too high/Cabinet Overtemperature	Cavity temperature too high, possible causes: 1 Inverter Installation Location not ventilated. 2 Ambient temperature is too high. 3 Internal fan operation abnormal.	1 Check if the ventilation of Inverter Installation Location is adequate and if the ambient temperature exceeds the maximum allowable range. 2 If there is no ventilation or the ambient temperature is too high, please improve the ventilation and heat dissipation conditions.
67	INV Module temperature too high/Inv Module Overtemperature	Inverter module temperature too high, possible causes: 1 Inverter Installation Location is not ventilated. 2 Ambient temperature is too high. 3 Internal fan operation abnormal.	3 If ventilation and ambient temperature are normal, please contact the dealer or GoodWe after-sales service center.

No.	fault name	fault cause	Troubleshooting recommendation
68	BoostModule temperature too high/Boost Module Overtemperature	BoostModule temperature too high, possible causes: 1 Inverter Installation Location is not ventilated. 2 Ambient temperature is too high. 3 Internal fan operation abnormal.	
69	Output filter capacitor overtemperature/AC Capacitor Overtemperature	Output filter capacitor temperature too high, possible causes: 1 Inverter Installation Location is not ventilated. 2 Ambient temperature is too high. 3 Internal fan operation abnormal.	

No.	fault name	fault cause	Troubleshooting recommendation
70	Relay2/Relay Failure 2	Relay abnormality, cause: 1 Relay abnormality (relay short circuit) 2 Relay sampling circuit abnormality. 3 Abnormal AC side wiring (possible loose connection or short circuit)	Disconnect the AC output side switch and DC input side switch, 5 After a few minutes, close the AC output side switch and the DC input side switch. If fault persists, please contact the dealer or GoodWe after-sales service center.
71	PV IGBT short circuit/PV IGBT Short Circuit	Possible causes: 1. IGBT short circuit 2. Inverter sampling circuit abnormality	Disconnect the AC output side switch and DC input side switch, 5 After a few minutes, close the AC output side switch and the DC input side switch. If fault persists, please contact the dealer or GoodWe after-sales service center.
72	PV IGBT Open circuit/PV IGBT Open Circuit	1. Software issue causing no wave transmission. 2. Drive circuit abnormality: 3. IGBT Open circuit	Disconnect the AC output side switch and DC input side switch, 5 After a few minutes, close the AC output side switch and the DC input side switch. If fault persists, please contact the dealer or GoodWe after-sales service center.

No.	fault name	fault cause	Troubleshooting recommendation
73	NTCAbnormal/NTC Abnormal	NTCTemperature sensor abnormality detected.	Disconnect the AC output side switch and DC input side switch,5 After a few minutes, close the AC output side switch and the DC input side switch. If fault persists, please contact the dealer or GoodWe after-sales service center.
74	Wave transmission anomaly fault/PWM Abnormal	PWMAbnormal waveform detected	Disconnect the AC output side switch and DC input side switch,5 After a few minutes, close the AC output side switch and the DC input side switch. If fault persists, please contact the dealer or GoodWe after-sales service center.
75	CPUInterrupt exception/CPU Interrupt Abnormal	CPUInterrupt anomaly	Disconnect the AC output side switch and DC input side switch,5 After a few minutes, close the AC output side switch and the DC input side switch. If fault persists, please contact the dealer or GoodWe after-sales service center.
76	Microelectronics/Microelectronic Failure	Functional safety detects an anomaly.	Disconnect the AC output side switch and DC input side switch,5 After a few minutes, close the AC output side switch and the DC input side switch. If fault persists, please contact the dealer or GoodWe after-sales service center.

No.	fault name	fault cause	Troubleshooting recommendation
77	PV HCTfault/PV HCT Failure	boostcurrent sensor anomaly	Disconnect the AC output side switch and DC input side switch,5 After a few minutes, close the AC output side switch and the DC input side switch. If fault persists, please contact the dealer or GoodWe after-sales service center.
78	1. 5VBaseline anomaly/1. 5V Ref Abnormal	Reference circuit	Disconnect the AC output side switch and DC input side switch,5 After a few minutes, close the AC output side switch and the DC input side switch. If fault persists, please contact the dealer or GoodWe after-sales service center.
79	0. 3VBaseline anomaly/0. 3V Ref Abnormal	Reference circuit	
80	CPLDVersion identification error/CPLD Version Error	CPLDVersion identification error	Disconnect the AC output side switch and DC input side switch,5 After a few minutes, close the AC output side switch and the DC input side switch. If fault persists, please contact the dealer or GoodWe after-sales service center.
81	CPLDCommunication fault/CPLD Comm Failure	CPLDandDSPCommunication content error or timeout	Disconnect the AC output side switch and DC input side switch,5 After a few minutes, close the AC output side switch and the DC input side switch. If fault persists, please contact the dealer or GoodWe after-sales service center.

No.	fault name	fault cause	Troubleshooting recommendation
82	Model Identification fault/Model Type Error	Regarding the fault of model identification error	Disconnect the AC output side switch and DC input side switch,5 After a few minutes, close the AC output side switch and the DC input side switch. If fault persists, please contact the dealer or GoodWe after-sales service center.
83	SVGPrecharge failureSVG Precharge Failure	SVGPrecharge hardware failure	Contact the distributor or GoodWe after-sales service center.
84	nightSVG PIDPrevention of fault/SVG Mode PID Prevention Failure	PIDPrevent hardware anomalies	Contact the distributor or GoodWe after-sales service center.
85	DSPVersion identification error/DSP Version Error	DSPSoftware version identification error	Disconnect the AC output side switch and DC input side switch,5 After a few minutes, close the AC output side switch and the DC input side switch. If fault persists, please contact the dealer or GoodWe after-sales service center.
86	Bus overvoltage/BUS Overvoltage		
87	Upper busbar overvoltage/P-BUS Overvoltage		
88	Lower busbar overvoltage/N-BUS Overvoltage		

No.	fault name	fault cause	Troubleshooting recommendation
89	Busbar overvoltage (auxiliaryCPU1) BUS Overvoltage(Slave CPU 1)	BUSOvervoltage, possible causes: 1. PVvoltage too high 2InverterBUSSampling anomaly 3The poor isolation effect of the rear-end double splitting leads to mutual interference between the two Inverter on-grid, causing one of them to report a DC overvoltage when Inverter on-grid.	Disconnect the AC output side switch and DC input side switch,5 After a few minutes, close the AC output side switch and the DC input side switch. If fault persists, please contact the dealer or GoodWe after-sales service center.
90	Upper busbar overvoltage (secondary)CPU1)/P-BUS Overvoltage(Slave CPU 1)		
91	Lower busbar overvoltage (secondary)CPU1)/N-BUS Overvoltage(Slave CPU 1)		
92	Busbar overvoltage (auxiliary)CPU2)/BUS Overvoltage(Slave CPU 2)		
93	Upper busbar overvoltage (secondary)CPU2)/P-BUS Overvoltage(Slave CPU 2)		
94	Lower busbar overvoltage (secondary)CPU2)/N-BUS Overvoltage(Slave CPU 2)		

No.	fault name	fault cause	Troubleshooting recommendation
95	Upper Bus Overvoltage(CPLD)/P-BUS Overvoltage(CPLD)		
96	Lower Bus Overvoltage (CPLD) / N-BUS Overvoltage (CPLD)		
97	MOSContinuous overvoltage/MOS Continuous Overvoltage	<ol style="list-style-type: none"> <li>1. Software issue causes inverter drive to shut down earlier than flyback drive.</li> <li>2. Inverter drive circuit abnormality causing failure to turn on.</li> <li>3. PVvoltage too high</li> <li>4. MosSampling anomaly</li> </ol>	<p>Disconnect the AC output side switch and DC input side switch,5 After a few minutes, close the AC output side switch and the DC input side switch. If fault persists, please contact the dealer or GoodWe after-sales service center.</p>
98	Busbar short circuit/Bus Short Circuit	<ol style="list-style-type: none"> <li>1. Hardware damage</li> </ol>	<p>In case of occurrenceBUSAfter a fault short circuit, the Inverter remains in an off-grid state. Please contact the dealer or GoodWe after-sales service center.</p>

No.	fault name	fault cause	Troubleshooting recommendation
99	Bus sampling abnormality/Bus Sample Abnormal	1. BusSampling hardware	Disconnect the AC output side switch and DC input side switch,5 After a few minutes, close the AC output side switch and the DC input side switch. If fault persists, please contact the dealer or GoodWe after-sales service center.
100	DCSide sampling anomaly/DC Sample Abnormal	1. Bus sampling hardware 2. Batteryvoltage Sampling Hardware fault 3. Dcrly relay	Disconnect the AC output side switch and DC input side switch,5 After a few minutes, close the AC output side switch and the DC input side switch. If fault persists, please contact the dealer or GoodWe after-sales service center.
101	PVInput overvoltage/PV Input Overvoltage	PVInput voltage is too high, possible causes: Incorrect PV array configuration, with too many PV Battery panels connected in series in the string, resulting in the string's open-circuit voltage exceeding the maximum operating voltage of the Inverter.	Check the series configuration of the corresponding PV array strings to ensure that the open-circuit voltage of the strings does not exceed the maximum working voltage of Inverter. Once the PV array is correctly configured, the Inverter alarm will automatically disappear.

No.	fault name	fault cause	Troubleshooting recommendation
102	PVContinuous hardware overcurrent/PV Continuous Hardware Overcurrent	1. Unreasonable module configuration 2. Hardware damage	Disconnect the AC output side switch and DC input side switch,5After a few minutes, close the AC output side switch and the DC input side switch. If fault persists, please contact the dealer or GoodWe after-sales service center.
103	PVContinuous software overcurrent/PV Continuous Software Overcurrent	1. Unreasonable module configuration 2. Hardware damage	
104	Flying capacitor software overvoltage/FlyCap Software Overvoltage	Flying capacitor overvoltage, possible causes: 1. PVvoltage too high 2Inverter flying capacitor voltage sampling anomaly;	Disconnect the AC output side switch and DC input side switch,5After a few minutes, close the AC output side switch and the DC input side switch. If fault persists, please contact the dealer or GoodWe after-sales service center.
105	Flying capacitor hardware overvoltage/FlyCap Hardware Overvoltage	Flying capacitor overvoltage, possible causes: 1. PVvoltage too high 2Inverter flying capacitor voltage sampling anomaly;	
106	Flying capacitor undervoltage/FlyCap Undervoltage	Flying capacitor undervoltage, possible causes: 1. PVEnergy deficiency; 2Inverter flying capacitor voltage sampling anomaly;	

No.	fault name	fault cause	Troubleshooting recommendation
107	Flying capacitor precharge failure/FlyCap Precharge Failure	Flying capacitor precharge failure, possible causes: 1. PVEnergy deficit; 2. Inverter flying capacitor voltage sampling anomaly;	
108	The flying capacitor cannot be precharged./FlyCap Precharge Abnormal	1. Unreasonable control loop parameters 2. Hardware damage	
109	String overcurrent(String1~16)/PV String Overcurrent(String 1~16)	Possible causes: 1. String overcurrent; 2. String current sensor anomaly	
110	String overcurrent(String17~32)/PV String Overcurrent(String 17~32)		
111	String reverse connection(String1~16)/PV String Reversed(String 1~16)	PVString reverse connection	Check if the string is reversed.

No.	fault name	fault cause	Troubleshooting recommendation
112	String reverse connection(String17~32)/PV String Reversed(String 17~32)	PVString reverse connection	Check if the string is reversed.
113	String loss(String1~16)/PV String Loss(String 1~16)	String fuse disconnected (if applicable)	Check if the fuse is blown.
114	String loss(String17~32)/PV String Loss(String 17~32)	String fuse disconnected (if applicable)	Check if the fuse is blown.
115	PVIncorrect access mode setting/PV Input Mode Error	<p>PVThere are three access modes in total, with four channels.MPPTFor example:</p> <p>1. Parallel mode: that isAAAAMode(homologous mode),PV1-PV4homologous4Ro adPVConnect the same photovoltaic panel</p> <p>2. Partial Parallel Mode: i.e.AACCMode,PV1an</p>	<p>InspectionPVIIs the access mode correctly set?ABCD、AACC、AAAA), reset in the correct way.PVConnection mode.</p> <p>1. Confirm the actual connected circuitsPVIIs the connection correct.</p> <p>2. IfPVCorrectly connected, passedAPPor screen check the current settingsPVWhether the "access mode" corresponds to the actual access mode.</p> <p>3. If the currently setPVThe "connection mode" does not</p>

No.	fault name	fault cause	Troubleshooting recommendation
		<p>dPV2Homologous connection,PV3andPV4homologous connection</p> <p>3. Stand-alone mode: i.e.ABCDMode(non-homologous),PV1、PV2、PV3、PV4Independent connection,4RoadPV</p> <p>Each connected to a photovoltaic panel</p> <p>IfPVThe actual connection mode and equipment configurationPVThis fault will be reported if the access mode does not match.</p>	<p>match the actual connection mode and needs to be adjusted.APPor the screen willPVSet the "Connection Mode" to match the actual situation. After completing the settings,PVandACPower supply disconnection and restart.</p> <p>4. After the setup is completed, if the currentPVThe access mode is consistent with the actual access mode, but this fault error is still reported. Please contact the dealer or GoodWe after-sales service center.</p>
116	String reverse connection(String33~48)/PV String Reversed(String 33~48)	PVString reverse connection	Check if the strings are reverse connected.
117	String loss(String33~48)/PV String Loss(String 33~48)	String fuse disconnected (if applicable)	Check if the fuse is blown.

No.	fault name	fault cause	Troubleshooting recommendation
118	String overcurrent(String33~48)/PV String Overcurrent(String 33~48)	Possible causes: 1. String overcurrent; 2. String current sensor anomaly	

No.	fault name	fault cause	Troubleshooting recommendation
119	Multi-string PV Phase Mismatch Failure	PV input mode setting error	<p>Check whether the PV connection mode is correctly set (ABCD, AACC, AAAA), and reset the PV connection mode according to the correct configuration.</p> <ol style="list-style-type: none"> <li>1. Verify that each connected PV string is correctly wired.</li> <li>2. If the PV is correctly connected, check via the APP or screen whether the currently set "PV Connection Mode" corresponds to the actual connection mode.</li> <li>3. If the currently set "PV Connection Mode" does not match the actual connection mode, it is necessary to use the APP or screen to set the "PV Connection Mode" to the mode consistent with the actual situation. After completing the settings, disconnect the PV and AC power supply and restart.</li> <li>4. After the setup is completed, if the current "PV Connection Mode" matches the actual connection mode but this fault still appears, please contact the dealer or GoodWe after-sales service center.</li> </ol>

No.	fault name	fault cause	Troubleshooting recommendation
120	Battery1Precharge resistor/BAT 1 Precharge Failure	Battery1Pre-Charge circuit fault (pre-Charge resistance burnout, etc.)	Check if the pre-circuit is in good condition, and verify that the Battery power on post-Battery voltage matches the busbar voltage. If they do not match, please contact the distributor or GoodWe after-sales service center.
121	Battery1Relay/BAT 1 Relay Failure	Battery1The relay fails to operate properly.	After Battery power on, check whether the Battery relay operates and if the closing sound is heard. If it does not function, please contact the dealer or GoodWe after-sales service center.
122	Battery1 overvoltage at connection point/BAT 1 Overvoltage	Battery1The input voltage exceeds the rated range of the machine.	Verify whether Battery voltage is within the machine's rated range.
123	Battery2Precharge resistor/BAT 2 Precharge Failure	Battery2Pre-Charge circuit fault (such as pre-Charge resistor burnout, etc.)	Check if the pre-Charge circuit is functioning properly. Only after Battery power on, verify whether the Battery voltage matches the busbar voltage. If they do not match, please contact the distributor or GoodWe after-sales service center.

No.	fault name	fault cause	Troubleshooting recommendation
124	Battery2Relay/BAT 2 Relay Failure	Battery2The relay fails to operate properly.	After Battery power on, check if the Battery relay is functioning and if the closing sound is audible. If it does not operate, please contact the distributor or GoodWe after-sales service center.
125	Battery2overvoltage at connection point/BAT 2 Overvoltage	Battery2Input voltage exceeds the rated range of the machine.	Verify whether Battery voltage is within the machine's rated range.
126	Battery1Reverse connection fault/BAT 1 Reversed	Battery1Reverse polarity of positive and negative terminals	Check whether the polarity of the Battery and machine terminals is consistent.
127	Battery2Reverse polarity fault/BAT 2 Reversed	Battery2Reverse polarity connection	Check whether the polarity of the Battery and machine terminals is consistent.
128	Abnormal connection of Battery/BAT Connection Abnormal	Abnormal Access	Check if the Battery is functioning properly.
129	Battery heat sink temperature too high/Bat Overtemperature	Battery temperature too high, possible causes: 1 Inverter Installation Location is not ventilated. 2 Ambient temperature is too high. 3 Internal fan operation abnormal.	

No.	fault name	fault cause	Troubleshooting recommendation
130	Reference voltage anomaly/Ref Voltage Abnormal	Reference circuit	Disconnect the AC output side switch and DC input side switch,5 After a few minutes, close the AC output side switch and the DC input side switch. If fault persists, please contact the dealer or GoodWe after-sales service center.
131	Cavity Temperature Too Low	Cavity temperature too low, possible causes: 1. The ambient temperature is too low.	
132	ACsideSPDfault/AC SPD Fault	ACFailure of the lateral lightning protection device	ReplacementACLateral lightning protection device.
133	DCsideSPDfault/DC SPD Fault	DCFailure of lateral lightning protection device	ReplacementDCLateral lightning protection device.
134	Internal fan anomaly/Internal Fan Abnormal	Internal fan abnormality, possible causes: 1Abnormal fan power supply; 2mechanical fault(Locked rotor); 3Fan aging and damage.	Disconnect the AC output side switch and DC input side switch,5 After a few minutes, close the AC output side switch and the DC input side switch. If fault persists, please contact the dealer or GoodWe after-sales service center.
135	External fan anomaly/External Fan Abnormal	External fan abnormality, possible causes: 1Fan power supply abnormality; 2Mechanical fault(Locked rotor); 3Fan aging and damage.	

No.	fault name	fault cause	Troubleshooting recommendation
136	PIDDiagnosis anomaly/PID Abnormal	PIDHardware fault orPVvoltage too highPIDSuspend	PVOvertoltage caused by voltagePIDPause WARNING No action required,PIDHardware fault can be turned off.PIDSwitch reclosure clearingPIDfault, replacementPIDdevice
137	Trip switch tripped WARNING/Trip-Switch Trip Warning	Possible causes: Overcurrent orPVReverse connection causes the trip switch to trip.	Please contact the dealer or GoodWe after-sales service center. The reason for disconnection is due to an occurrence.PVShort circuit or reverse connection, need to check for historical records.PVShort circuit or historyPVReverse connection of WARNING. If present, maintenance personnel should inspect the corresponding issue.PVAfter confirming there is no fault, the tripping switch can be manually closed, and then activated viaAPPInterface Clear History fault Operation Clears This WARNING.

No.	fault name	fault cause	Troubleshooting recommendation
138	historyPV IGBT short circuit/PV IGBT Short Circuit Warning	Possible causes: Overcurrent caused the trip switch to open.	Please contact the distributor or GoodWe after-sales service center. Maintenance personnel should follow the historicalPVShort circuit WARNING subcode, check for short circuit occurrenceBoostCheck if there is any fault in the hardware and external string; After confirming no fault, it can pass.APPInterface Clear History fault Operation Clears This WARNING.
139	HistoryPVReverse connection WARNING(String1~16)/PV String Reversed Warning(String 1~16)	Possible causes: occurrencePVReverse connection causes the trip switch to trip.	Contact the dealer or GoodWe after-sales service center. The maintenance personnel must follow the historicalPVReverse the WARNING subcode and check whether the corresponding string is reversed.PVIs there a voltage difference in the panel configuration? After checking and confirming no fault, it can be passed.APPInterface Clear History fault Operation Clears This WARNING.

No.	fault name	fault cause	Troubleshooting recommendation
140	historyPVReverse polarity(String17~32)/ PV String Reversed Warning(String 17~32)	Possible causes: occurrencePVReverse connection causes the trip switch to trip.	Contact the distributor or GoodWe after-sales service center. Maintenance personnel must follow the historicalPVReverse connection WARNING subcode, check whether the corresponding string is reversed, checkPVIIs there a voltage difference in the panel configuration? After checking and confirming no fault, it can proceed.APPInterface Clear History fault Operation Clears This WARNING.
141	FlashRead/Write Error Flash R/W Error	Possible causes: flashContent has changed;flashEnd of life	1. Upgrade to the latest version of the program. 2. Contact the distributor or GoodWe after-sales service center.
142	Meter communication abnormal alarm/Meter Comm Loss	This WARNING may only be reported after enabling the power limit function. Possible causes: 1. Meter not connected; 2. The communication line connecting the meter to the Inverter is wired incorrectly.	Check the meter wiring and ensure it is correctly connected. If fault persists after inspection, please contact the dealer or GoodWe after-sales service center.

No.	fault name	fault cause	Troubleshooting recommendation
143	PVPanel type identification failed/PV Type Identification Failure	PVPanel identification hardware anomaly	Contact the distributor or GoodWe after-sales service center.
144	String mismatch/PV String Mismatch	PVString mismatch, same circuitMPPTThe configurations of the two open-circuit voltage strings below are different.	Check the two strings open-circuit voltage, and configure the strings with the same open-circuit voltage to the same circuit.MPPTUnder prolonged string mismatch, there are potential safety hazards.
145	CTUnconnected/CT Loss	CTUnconnected	InspectionCTWiring.
146	CTReverse connection/CT Reversed	CTReverse connection	InspectionCTWiring.
147	Ground wire missing/PE Loss	Ground wire not connected	Check the ground wire.
148	String terminal temperature high(String1~8)/PV String Terminal Overtemperature(String 1~8)	37176RegisterPVterminal temperature alarm subcode1Set	-
149	String terminal temperature high(String9~16)/PV String Terminal Overtemperature(String 9~16)	37177RegisterPVterminal temperature alarm subcode2Set	-

No.	fault name	fault cause	Troubleshooting recommendation
150	String terminal temperature high(String17~20)/PV String Terminal Overtemperature(String 17~20)	37178RegisterPVterminal temperature alarm subcode3Set position	-
151	HistoryPVReverse connection WARNING(String33~48)/PV String Reversed Warning(String 33~48)	Possible causes: occurrencePVReverse connection causes the trip switch to trip.	Please contact the distributor or GoodWe after-sales service center; maintenance personnel must follow the historicalPVReverse polarity WARNING subcode, check whether the corresponding string has reverse polarity, checkPVIIs there a voltage difference in the panel configuration? After checking and confirming no fault, it can proceed.APPInterface Clear History fault Operation Clears This WARNING.
152	Battery1BAT1 Voltage Low	Batteryvoltage is below the set value	-
153	Battery2voltage Low/BAT2 Voltage Low	Batteryvoltage is below the set value	-
154	Battery Power Supplyvoltage Low/Low Voltage of BAT Power	Battery non-Charge mode, voltage below shutdown voltage	-
155	Battery1voltageHigh/BAT1 Voltage High	-	-

No.	fault name	fault cause	Troubleshooting recommendation
156	Battery2voltage High/BAT2 Voltage High	-	-
157	Online Detection of Low Insulation Resistance	PV String is short-circuited to the ground of Protection. 2. The environment of PV StringInstallation is consistently humid, and the line-to-ground insulation is poor.	1. Check the impedance between PV String and Protection to ground. If a short circuit is found, rectify the short circuit point. 2. Check if the Inverter's PE cable is properly connected. 3. If it is confirmed that the impedance is indeed lower than the default value in rainy weather, please reset the "insulation resistanceProtection point".
158	Microgrid Overload Warning	Excessive input at backup terminal current	Occasional occurrences require no action; if this alarm appears frequently, please contact the dealer or GoodWe after-sales service center.
159	Manual Reset	-	-
160	Generator phase Abnormal/Generator Phase Order Error	-	-
161	Multiplexed Port Configuration Abnormal	Reuse (Generator) port configured as microgrid or large load, but actually connected to generator	Use the APP to modify the reuse (generator) port configuration.

No.	fault name	fault cause	Troubleshooting recommendation
162	Parallel Communication Timeout Shutdown	-	-
163	One-click Remote Shutdown	-	-
164	Offline Shutdown/One-click Remote Shutdown	-	-
165	Remote Shutdown/One-click Remote Shutdown	-	-
166	Child node communication/One-click Remote Shutdown	-	-
167	Generator Communication Failure/DG Communication Failure	Abnormal communication link between the control board and the diesel generator	<ol style="list-style-type: none"> <li>1. Check the link communication harness and observe whether fault is eliminated.</li> <li>2. Attempt to restart the machine and observe whether the fault is eliminated;</li> <li>3. If the fault persists after restarting, please contact GoodWe's after-sales service center.</li> </ol>
168	Battery Overvoltage Protection / Battery Over Voltage	<ol style="list-style-type: none"> <li>1. Single cell voltage too high</li> <li>2. voltage collection line anomaly</li> </ol>	-

No.	fault name	fault cause	Troubleshooting recommendation
		1. Battery total pressure too high 2. Abnormal voltage collection line	-
169	Battery Undervoltage Protection/Battery Under Voltage	1. Single cell voltage too low 2. voltage collection line abnormality 1. Battery Total pressure too low 2. Abnormal voltage collection line	-
170	Overcurrent / Battery Over Current	1. Chargecurrent is too large, Battery current limiting is abnormal: temperature and voltage value mutation 2. Inverter response anomaly Battery dischargecurrent is too large	-
171	Battery Over Temperature Protection / Battery Over Temperature	1. Ambient temperature too high 2. Temperature sensor abnormality	-

No.	fault name	fault cause	Troubleshooting recommendation
		1. Ambient temperature too high 2. Temperature sensor abnormality	
172	Battery Low Temperature Protection/Battery Under Temperature	1. Ambient temperature is too low 2. Temperature sensor abnormality 1. The ambient temperature is too low. 2. Temperature sensor abnormality	-
173	Battery Pole Over Temperature	Pole temperature too high	-

No.	fault name	fault cause	Troubleshooting recommendation
174	Battery Imbalance	<p>1. Excessive temperature difference at different stages, Battery will impose restrictions on BatteryPower, i.e., limit the charging Dischargecurrent. Therefore, this issue is generally unlikely to occur.</p> <p>2. The capacity of the battery cell degrades, leading to excessive internal resistance, significant temperature rise during current, and consequently, a large temperature difference.</p> <p>3. Poor welding of battery cell tabs, leading to excessive current and rapid temperature rise in the cell.</p> <p>4. Temperature sampling issue;</p> <p>5. power cable loose connection</p>	-

No.	fault name	fault cause	Troubleshooting recommendation
		<p>1. Inconsistent aging levels of battery cells</p> <p>2. Issues with the tab chips can also lead to excessive voltage differences between cells.</p> <p>3. Imbalance issues in the battery pack can also lead to excessive voltage differences between cells.</p> <p>4. Harness issue causing</p>	
		<p>1. Inconsistent aging levels of battery cells</p> <p>2. Issues with the board chips can also lead to excessive voltage differences between battery cells.</p> <p>3. Imbalance issues in the battery pack can also lead to excessive voltage differences between cells.</p> <p>4. Wiring harness issue causing</p>	

No.	fault name	fault cause	Troubleshooting recommendation
175	Insulation Resistance	Insulation resistance failure	Check if the ground wire is properly connected and restart the Battery. If the issue persists after restarting, please contact GoodWe's after-sales service center.
176	Precharge Failure	Precharge failure	It indicates that during the precharge process, the voltage across the precharge MOS consistently exceeds the specified threshold. After restarting the system, observe whether this fault persists, and check if the wiring is correct and if the precharge MOS is damaged.
177	Collection Line Failure	Battery acquisition line poor contact or disconnected	Check the wiring and restart the Battery. If the issue persists after restarting, please contact GoodWe's after-sales service center.
		Single PV module string harness disconnected	Check the wiring and restart the Battery. If the issue persists after restarting, please contact GoodWe's after-sales service center.
		Single temperature acquisition line poor contact or disconnected	

No.	fault name	fault cause	Troubleshooting recommendation
		Dual-channel current comparison error is too large, or current acquisition line circuit is abnormal.	
		Dual-channel voltage comparison error is too large, or MCU and AFE voltage comparison error is too large, or voltage acquisition line loop is abnormal.	
		Temperature acquisition circuit loop abnormal or poor contact, disconnected	
		Overvoltage level 5 or overtemperature level 5, fuse the three-terminal fuse	
178	Relay or MOS Over Temperature	Relay or MOSFET overtemperature	The fault indicates that the MOSFET temperature has exceeded the specified threshold. Power off and let it stand for 2 hours to allow temperature recovery.

No.	fault name	fault cause	Troubleshooting recommendation
179	Shunt Over Temperature	Shunt Over-temperature	The fault indicates that the bypass diode temperature has exceeded the specified threshold. Shut down and allow it to stand for 2 hours to wait for temperature recovery.
180	BMS1 Other Failure 1 (RES)	Relay or MOS open circuit	<ol style="list-style-type: none"> <li>1. Upgrade the software, power off and let it sit for 5 minutes, then check if fault persists after restarting.</li> <li>2. If the issue persists, replace the Battery package.</li> </ol>
		Relay or MOS short circuit	<ol style="list-style-type: none"> <li>1. Upgrade the software, power off and let it sit for 5 minutes, then check if fault persists after restarting.</li> <li>2. If the issue persists, replace the Battery package.</li> </ol>
		Communication abnormality between the master cluster and slave cluster, or inconsistency of battery cells between clusters.	<ol style="list-style-type: none"> <li>1. Check the Battery information and software version of the slave device, and verify whether the communication line connection with the master device is normal.</li> <li>2. Upgrade the software</li> </ol>

No.	fault name	fault cause	Troubleshooting recommendation
		Battery system circuit harness abnormality, resulting in interlocking signal not forming a loop.	Check if Terminal resistor Installation is correct
		BMS and PCS communication anomaly	Verify whether the communication line interface definition between Inverter and Battery is correct; 2. Please contact GoodWe's after-sales service center to check the backend data and verify whether the Inverter and Battery software are correctly matched.
		Abnormal communication harness between BMS master and slave control	Check the wiring and restart the Battery. 2. Upgrade the Battery. If the issue persists after restarting, please contact GoodWe's after-sales service center.
		Communication loss between main and auxiliary chips	

No.	fault name	fault cause	Troubleshooting recommendation
		Abnormal MCCB and shunt trip	Let the system stand idle and shut down for 5 minutes, then restart to check if fault persists. 2. Check for any looseness or misalignment in the blind-mating and communication pins at the bottom of the PACK and PCU.
		MCU self-test failed	Upgrade the software and restart the Battery. If the issue persists after restarting, please contact GoodWe's after-sales service center.
		The software version is too low or the BMS board is damaged. 2. The number of Inverter parallel units is large, and the Battery experiences excessive impact during pre-charging.	1. Upgrade the software and observe whether fault persists. 2. In the case of parallel operation, perform a black start on Battery before starting Inverter.
		MCU internal fault	Upgrade the software and restart the Battery. Generally, this is to detect whether the MCU or external components are damaged. If the issue persists after restarting, please contact GoodWe's after-sales service center.

No.	fault name	fault cause	Troubleshooting recommendation
		Master control current exceeds the specified threshold	<ol style="list-style-type: none"> <li>1. Let the system stand for 5 minutes, then restart and check if fault persists.</li> <li>2. Check if the Inverter is set with an excessively large Power, causing it to exceed the bus load.</li> </ol>
		Cell inconsistency in parallel clusters	Confirm whether the cells in cluster Battery are consistent.
		Cluster Battery reverse polarity of positive and negative terminals	Check whether the positive and negative poles of the string Battery are reversed.
		Severe overheating or overvoltage triggering the fire protection system	Contact GoodWe After-Sales Service Center.
181	Air Conditioner Failure	Abnormal failure of air conditioning	Try restarting the system. If fault persists, please contact GoodWe Customer Service Center.
		Cabinet door not closed	Check whether the cabinet door is properly closed.
		Power supply voltage too high	Verify that the power supply voltage value meets the air conditioning input voltage requirements, and proceed with re-power on only after confirmation.
		Insufficient power supply	
		No voltage Input	

No.	fault name	fault cause	Troubleshooting recommendation
		Unstable power supply voltage	Try restarting the system. If the fault persists, please contact GoodWe Customer Service Center.
		Compressor instability	
		Sensor poor contact or damaged	
		Abnormal air conditioning fan	
181	BMS1 Other Failure 2 (RES) / BMS2 Other Failure 2 (RES)	There is an abnormality in the voltage or current inside the DCDC.	Refer to the specific DCfault content for details.
		DCDC overload or heat sink temperature too high	
		Abnormal cell acquisition or inconsistent aging levels	Please contact the GoodWe After-Sales Service Center.
		Fan operation not executed properly	Please contact GoodWe after-sales service center.
Output port screw loose or poor contact	<ol style="list-style-type: none"> <li>1. Battery Shut down, check wiring and output port screw status</li> <li>2. After confirmation, restart the Battery and observe whether the fault persists. If it does, please contact GoodWe's after-sales service center.</li> </ol>		

No.	fault name	fault cause	Troubleshooting recommendation
		Battery has been used for too long or the battery cell is severely damaged.	Please contact GoodWe after-sales service center to replace the pack.
		The software version is too low or the BMS board is damaged. 2. The number of Inverter parallel units is large, and the Battery experiences excessive impact during pre-charging.	1. Upgrade the software and observe whether fault persists. 2. In the case of parallel operation, perform a black start on Battery before starting Inverter.
		Heating film damaged	Please contact GoodWe After-Sales Service Center.
		The three-terminal fuse of the heating film is blown, rendering the heating function unusable.	Please contact GoodWe After-Sales Service Center.
		Software model, Cell Type, hardware model mismatch	Check whether the software model, serial number (SN), Cell Type, and hardware model are consistent. If they are inconsistent, please contact GoodWe after-sales service center.

No.	fault name	fault cause	Troubleshooting recommendation
		Thermal management board communication disconnection	Let the system stand idle and shut down for 5 minutes, then restart to check if fault persists. 2. If the fault is not restored, contact GoodWe after-sales service to replace the pack.
		Thermal management board communication disconnection	Let the system stand idle and shut down for 5 minutes, then restart to check if fault persists. 2. If the fault is not restored, contact GoodWe after-sales service to replace the pack.
		Thermal management board communication disconnection	Let the system stand idle and shut down for 5 minutes, then restart to check if fault persists. 2. If the fault is not restored, contact GoodWe after-sales service to replace the pack.
		Pack fan fault signal trigger	Let the system stand idle and shut down for 5 minutes, then restart to check if fault persists. 2. If the fault is not restored, contact GoodWe after-sales service to replace the pack.

No.	fault name	fault cause	Troubleshooting recommendation
182	DCDC Converter/DCDC Failure	Output portvoltage too high	Check the output portvoltage. If the output portvoltage is normal and the fault still cannot be resolved after restarting Battery, please contact GoodWe after-sales service center.
		The DCDC module detected that the Batteryvoltage exceeded the maximum Chargevoltage.	Stop Charge and Discharge when SOC drops below 90% or remains idle for 2 hours. If the issue persists and restarting fault does not resolve it, please contact GoodWe Customer Service Center.
		Radiator temperature too high	Let the Battery stand for 1 hour until the radiator temperature drops. If the issue persists and fault still occurs after restarting, please contact GoodWe's after-sales service center.
		Battery dischargecurrent is too large	Check if the load exceeds the Battery's Discharge capability. Turn off the load or stop the PCS for 60 seconds. If the issue persists after restarting the fault, please contact GoodWe's after-sales service center.

No.	fault name	fault cause	Troubleshooting recommendation
		The positive and negative terminals of the port power harness are reversed with the combiner box Battery or PCS.	Turn off the Battery manual switch, check if the output port wiring is correct, and restart the Battery.
		The Power output relay cannot close.	Check whether the output port wiring is correct and if there is a short circuit. If the issue persists after restarting fault, please contact GoodWe after-sales service center.
		Power device temperature too high	Let the Battery stand for 1 hour to allow the temperature of internal Power components to decrease. If the issue persists and restarting the fault does not resolve it, please contact GoodWe Customer Service Center.
		Relay sticking	Restart fault still exists. Please contact GoodWe after-sales service center.
183	Inter-cluster circulating current/Battery Rack Circulating Current Failure	1. Cell imbalance 2. First power on undercharge correction	-

No.	fault name	fault cause	Troubleshooting recommendation
184	BMS1 Other Failure 3 (Utility-Scale Storage) / BMS2 Other Failure 3 (LES)	Communication exception with Linux module	<ol style="list-style-type: none"> <li>1. Check if the communication link is functioning properly.</li> <li>2. Upgrade the software and restart the Battery to observe if the fault persists. If it does, please contact GoodWe's after-sales service center.</li> </ol>
		Excessive temperature rise in battery cells	Abnormal battery cell, contact GoodWe after-sales service to replace the pack.
		SOC below 10%	Perform Charge on Battery.
		SN writing does not comply with the rules	Check if the SN digits are normal. If abnormal, please contact GoodWe after-sales service center.
		<ol style="list-style-type: none"> <li>1. Battery Daisy chain communication anomaly within the cluster</li> <li>2. Inconsistent aging levels of cells between Battery clusters</li> </ol>	<ol style="list-style-type: none"> <li>1. Check the contact condition of the single cluster Battery pack.</li> <li>2. Confirm the usage of each cluster Battery, such as cumulative charge Discharge capacity, cycle count, etc.</li> <li>3. Please contact GoodWe After-Sales Service Center.</li> </ol>
		High Humidity inside the pack	-
		Fuse blown	Contact GoodWe after-sales service to replace the pack.
		Low Battery power	Perform Charge on Battery.

No.	fault name	fault cause	Troubleshooting recommendation
185	BMS1 Other Failure 4 (LES) / BMS2 Other Failure 4 (LES)	Circuit breaker anomaly	Contact GoodWe after-sales service to replace the pack.
		External device abnormality	Contact GoodWe after-sales service to replace the pack.
186	Contactor fault1/Contactor Fault 1	-	-
187	Contactor fault 2/Contactor Fault 2	-	-
188	Overload protection (Ksic)	Continuous overload (exceeding 690KVA) for 10s	Please contact GoodWe After-Sales Service Center.
186	Overload (Smart Protection/Overload Protection (SP))	Continuous overload (exceeding 690KVA) for 10s	Please contact GoodWe After-Sales Service Center.
190	Communication abnormality between the host AC and the meter when AC is powered on in parallel system	1. The meter may not be connected to the host. 2. The meter communication cable may be loose.	1. Check if the meter is connected to the host. 2. Check if the meter communication cable is loose.
191	The slave power meter in the parallel system is abnormal	The meter is connected to the slave unit.	Set the meter connection machine as the master.

No.	fault name	fault cause	Troubleshooting recommendation
192	Slave ACpower on communication timeout with master for over 10 minutes after power-on/In a parallel system, the slave device has a communication timeout with the master device after AC power-on for more than 10 minutes	<ol style="list-style-type: none"> <li>1. Incorrect slave address setting</li> <li>2. Slave communication line is loose</li> </ol>	<ol style="list-style-type: none"> <li>1. Check if the slave address is duplicated</li> <li>2. Check if the parallel communication cable is loose.</li> </ol>

### 11.5.2.2 Battery failure

No.	Fault	Cause	Troubleshooting Suggestions:
1	BMS1 RACK1 Total voltage is too high warning	<ol style="list-style-type: none"> <li>1. Battery system voltage too high</li> <li>2. Voltage collection line abnormal</li> </ol>	<ol style="list-style-type: none"> <li>1. Discharge the battery to see if the fault persists.</li> <li>2. If the fault persists, contact the GoodWe After-Sales Service Center.</li> </ol>

No.	Fault	Cause	Troubleshooting Suggestions:
2	BMS1 RACK1 Total voltage is too low warning	1. Battery system voltage too low 2. Voltage collection line abnormal	1. Charge the battery and leave it to see if the fault persists. 2. Check the inverter operation to see if it is not charging the battery due to problems such as the operating mode. Try charging the battery through the inverter and see if the fault is resolved. 3. If the fault is not restored, please contact the after-sales service center.
3	BMS1 RACK1 Cell voltage is too high warning	1. Individual cell voltage is too high 2. Voltage collection line is abnormal	1. Discharge the battery and leave it idle to see if the fault persists. 2. If the fault persists, contact the GoodWe After-Sales Service Center.

No.	Fault	Cause	Troubleshooting Suggestions:
4	BMS1 RACK1 Cell voltage is too low warning	1. Individual cell voltage is too low 2. Voltage collection line is abnormal	1. Charge the battery and leave it to see if the fault persists. 2. Check the inverter operation to see if it is not charging the battery due to problems such as the operating mode. Try charging the battery through the inverter and see if the fault is resolved. 3. If the fault persists, contact GoodWe after-sales service.
5	BMS1 RACK1 Charging temperature is too high warning	1. Environment temperature too high 2. Temperature sensor malfunction	1. Stop charging and discharging, and leave it idle to see if the fault persists. 2. If the fault persists, contact the GoodWe After-Sales Service Center.

No.	Fault	Cause	Troubleshooting Suggestions:
6	BMS1 RACK1 Discharging temperature is too high warning	1. Environment temperature too high 2. Temperature sensor malfunction	1. Stop charging and discharging, and leave it idle to see if the fault persists. 2. If the fault persists, contact the GoodWe After-Sales Service Center.
7	BMS1 RACK1 Charging temperature is too low warning	1. Environment temperature too low 2. Temperature sensor malfunction	1. Check the cell temperature in the background. If the lowest temperature is higher than -20°C, set the battery to discharge to raise the cell temperature. 2. If the temperature is below -20°C, turn off the battery and place it in a warm environment. Wait until the battery temperature rises before using it. 3. If the fault is not restored, please contact the after-sales service center.

No.	Fault	Cause	Troubleshooting Suggestions:
8	BMS1 RACK1 Discharging temperature is too low warning	<ol style="list-style-type: none"> <li>1. Environment temperature too low</li> <li>2. Temperature sensor malfunction</li> </ol>	<ol style="list-style-type: none"> <li>1. Check the cell temperature in the background. If the lowest temperature is higher than -20°C, set the battery to discharge to raise the cell temperature.</li> <li>2. If the temperature is below -20°C, turn off the battery and place it in a warm environment. Wait until the battery temperature rises before using it.</li> <li>3. If the fault is not restored, please contact the after-sales service center.</li> </ol>
9	BMS1 RACK1 Charge overcurrent warning	<ol style="list-style-type: none"> <li>1. Excessive charging current, abnormal battery current limiting: sudden changes in temperature and voltage values</li> <li>2. Abnormal inverter response</li> </ol>	<ol style="list-style-type: none"> <li>1. Stop charging and leave it alone to see if the fault persists;</li> <li>2. Check whether the inverter is set to excessive power, causing it to exceed the rated working current of the battery;</li> <li>3. If the overcurrent persists, contact the GoodWe after-sales service center.</li> </ol>

No.	Fault	Cause	Troubleshooting Suggestions:
10	BMS1 RACK1 Discharge overcurrent warning	1. Excessive discharging current, abnormal battery current limiting: sudden changes in temperature and voltage values 2. Abnormal inverter response	1. Stop discharging and leave it alone to see if the fault persists; 2. Check whether the inverter is set to excessive power, causing it to exceed the rated working current of the battery; 3. If the overcurrent persists, contact the GoodWe after-sales service center.
11	BMS1 RACK1 Insulation resistance is too low warning	Insulation resistance damage or abnormal contact	Check whether the ground wire is properly connected, restart the battery, and if the problem persists after restarting, please contact GoodWe After-Sales Service Center.

No.	Fault	Cause	Troubleshooting Suggestions:
12	BMS1 RACK1 Cell excessive temperature differentials warning	<p>1. When the temperature difference is too large at different stages, the battery will limit the battery power, i.e., limit the charging and discharging current. Therefore, this problem generally does not occur.</p> <p>2. Battery cell capacity depletion leads to excessive internal resistance, resulting in significant temperature rise during overcurrent conditions and a large temperature difference.</p> <p>3. Poor welding of the cell tabs causes excessive current flow, resulting in rapid heating of the cell.</p> <p>4. Temperature sampling issues;</p> <p>5. Loose power line connections</p>	Turn off the device, restart the battery, and wait for 2 hours. If the problem persists, contact GoodWe After-Sales Service Center.

No.	Fault	Cause	Troubleshooting Suggestions:
13	BMS1 RACK1 Post temperature is too high warning	Excessive pole temperature	<ol style="list-style-type: none"> <li>1. Stop charging and discharging, and leave it idle to see if the fault persists.</li> <li>2. If the fault persists, contact the GoodWe After-Sales Service Center.</li> </ol>
14	BMS1 RACK1 Cell excessive voltage differentials warning	<ol style="list-style-type: none"> <li>1. Inconsistent battery cell aging</li> <li>2. Board chip issues can also cause excessive battery cell pressure differences;</li> <li>3. Board balancing issues can also cause excessive battery cell pressure differences</li> <li>4. Wiring harness issues cause</li> </ol>	<ol style="list-style-type: none"> <li>1. Stop charging and discharging, and leave it idle to see if the fault persists.</li> <li>2. If the fault persists, contact the GoodWe After-Sales Service Center.</li> </ol>
15	BMS1 RACK1 PCS communication loss warning	BMS and PCS communication error	Check that the communication cable between the battery and the inverter is properly connected.
16	BMS1 RACK1 DCDC warning	Abnormal voltage or current exists inside the DCDC.	Upgrade the software, restart the battery, and if the problem persists after restarting, please contact the Solid State After-Sales Service Center.

No.	Fault	Cause	Troubleshooting Suggestions:
17	BMS1 RACK1 Heat film MOS adhesion warning	Heating film MOS damaged	Contact the after-sales service.
18	BMS1 RACK1 Heat film MOS open warning	Heating circuit malfunction	Contact the after-sales service.
19	BMS1 RACK1 Total voltage is too high fault	<ol style="list-style-type: none"> <li>1. Battery system voltage too high</li> <li>2. Voltage collection line abnormal</li> </ol>	<ol style="list-style-type: none"> <li>1. Discharge the battery to see if the fault persists.</li> <li>2. If the fault persists, contact the GoodWe After-Sales Service Center.</li> </ol>
20	BMS1 RACK1 Total voltage is too low fault	<ol style="list-style-type: none"> <li>1. Battery system voltage too low</li> <li>2. Voltage collection line abnormal</li> </ol>	<ol style="list-style-type: none"> <li>1. Charge the battery and leave it to see if the fault persists.</li> <li>2. Check the inverter operation to see if it is not charging the battery due to problems such as the operating mode. Try charging the battery through the inverter and see if the fault is resolved.</li> <li>3. If the fault persists, please contact the GoodWe After-Sales Service Center.</li> </ol>
21	BMS1 RACK1 Cell voltage is too high fault	<ol style="list-style-type: none"> <li>1. Individual cell voltage is too high</li> <li>2. Voltage collection line is abnormal</li> </ol>	<ol style="list-style-type: none"> <li>1. Discharge the battery and leave it to see if the fault persists.</li> <li>2. If the fault persists, please contact the GoodWe After-Sales Service Center.</li> </ol>

No.	Fault	Cause	Troubleshooting Suggestions:
22	BMS1 RACK1 Cell voltage is too low fault	1. Individual cell voltage is too low 2. Voltage collection line is abnormal	1. Charge the battery and leave it to see if the fault persists. 2. Check the inverter operation to see if it is not charging the battery due to problems such as the operating mode. Try charging the battery through the inverter and see if the fault is resolved. 3. If the fault persists, please contact the GoodWe After-Sales Service Center.
23	BMS1 RACK1 Charging temperature is too high fault	1. Environment temperature too high 2. Temperature sensor malfunction	1. Place the battery in a cool place, turn off the device, and leave it for 30 minutes. Restart the device and check if the fault persists. 2. If the fault persists, please contact the Solid State Technology after-sales service center.

No.	Fault	Cause	Troubleshooting Suggestions:
24	BMS1 RACK1 Discharging temperature is too high fault	<ol style="list-style-type: none"> <li>1. Environment temperature too high</li> <li>2. Temperature sensor malfunction</li> </ol>	<ol style="list-style-type: none"> <li>1. Place the battery in a cool place, turn off the device, and leave it for 30 minutes. Restart the device and check if the fault persists.</li> <li>2. If the fault persists, please contact the Solid State Technology after-sales service center.</li> </ol>
25	BMS1 RACK1 Charging temperature is too low fault	<ol style="list-style-type: none"> <li>1. Environment temperature too low</li> <li>2. Temperature sensor malfunction</li> </ol>	<ol style="list-style-type: none"> <li>1. Check the cell temperature in the background. If the lowest temperature is higher than -20°C, set the battery to discharge to raise the cell temperature.</li> <li>2. If the temperature is below -20°C, turn off the battery and place it in a warm environment. Wait until the battery temperature rises before using it.</li> <li>3. If the fault is not restored, please contact the after-sales service center.</li> </ol>

No.	Fault	Cause	Troubleshooting Suggestions:
26	BMS1 RACK1 Discharging temperature is too low fault	<ol style="list-style-type: none"> <li>1. Environment temperature too low</li> <li>2. Temperature sensor malfunction</li> </ol>	<ol style="list-style-type: none"> <li>1. Check the cell temperature in the background. If the lowest temperature is higher than -20°C, set the battery to discharge to raise the cell temperature.</li> <li>2. If the temperature is below -20°C, turn off the battery and place it in a warm environment. Wait until the battery temperature rises before using it.</li> <li>3. If the fault is not restored, please contact the after-sales service center.</li> </ol>
27	BMS1 RACK1 Charge temperature is too low fault	<ol style="list-style-type: none"> <li>1. Excessive charging current, abnormal battery current limiting: sudden changes in temperature and voltage values</li> <li>2. Abnormal inverter response</li> </ol>	<ol style="list-style-type: none"> <li>1. Stop discharging and leave it alone to see if the fault persists;</li> <li>2. Check whether the inverter is set to excessive power, causing it to exceed the rated working current of the battery;</li> <li>3. If the overcurrent persists, contact the GoodWe after-sales service center.</li> </ol>

No.	Fault	Cause	Troubleshooting Suggestions:
28	BMS1 RACK1 Discharge overcurrent fault	1. Excessive discharging current, abnormal battery current limiting: sudden changes in temperature and voltage values 2. Abnormal inverter response	1. Stop discharging and leave it alone to see if the fault persists; 2. Check whether the inverter is set to excessive power, causing it to exceed the rated working current of the battery; 3. If the overcurrent persists, contact the GoodWe after-sales service center.
29	BMS1 RACK1 Insulation resistance is too low fault	Insulation resistance damage or abnormal contact	1. Check whether the ground wire is properly connected and restart the battery. 2. Upgrade the software. If the problem persists, please contact the GoodWe After-Sales Service Center.

No.	Fault	Cause	Troubleshooting Suggestions:
30	BMS1 RACK1 Cell excessive temperature differentials fault	<p>1. When the temperature difference is too large at different stages, the battery will limit the battery power, i.e., limit the charging and discharging current. Therefore, this problem generally does not occur.</p> <p>2. Battery cell capacity depletion leads to excessive internal resistance, resulting in significant temperature rise during overcurrent conditions and a large temperature difference.</p> <p>3. Poor welding of the cell tabs causes excessive current flow, resulting in rapid heating of the cell.</p> <p>4. Temperature sampling issues;</p> <p>5. Loose power line connections</p>	Turn off the device, restart the battery, and wait for 2 hours. If the problem persists, contact GoodWe After-Sales Service Center.

No.	Fault	Cause	Troubleshooting Suggestions:
31	BMS1 RACK1 Post temperature is too high fault	Excessive pole temperature	<ol style="list-style-type: none"> <li>1. Shut down the device and leave it idle for 30 minutes, then restart it to see if the fault persists.</li> <li>2. If the fault persists, please contact the GoodWe After-Sales Service Center.</li> </ol>
32	BMS1 RACK1 Cell excessive voltage differentials fault	<ol style="list-style-type: none"> <li>1. Inconsistent battery cell aging</li> <li>2. Board chip issues can also cause excessive battery cell pressure differences;</li> <li>3. Board balancing issues can also cause excessive battery cell pressure differences</li> <li>4. Wiring harness issues cause</li> </ol>	Turn off the device, restart the battery, and wait for 2 hours. If the problem persists, contact GoodWe After-Sales Service Center.
33	BMS1 RACK1 Relay or MOS short-circuit fault	MOS short circuit	<ol style="list-style-type: none"> <li>1. Upgrade the software, shut down the device and leave it idle for 5 minutes, then restart it to see if the fault persists.</li> <li>2. If the fault persists, contact the GoodWe After-Sales Service Center.</li> </ol>

No.	Fault	Cause	Troubleshooting Suggestions:
34	BMS1 RACK1 Relay or MOS open-circuit fault	MOS open circuit	<ol style="list-style-type: none"> <li>1. Upgrade the software, shut down the device and leave it idle for 5 minutes, then restart it to see if the fault persists.</li> <li>2. If the fault persists, contact the GoodWe After-Sales Service Center.</li> </ol>
35	BMS1 RACK1 The precharge failed fault	The voltage across the precharge MOS always exceeds the specified threshold.	<ol style="list-style-type: none"> <li>1. Upgrade the software, shut down the device and leave it idle for 5 minutes, then restart it to see if the fault persists.</li> <li>2. If the fault persists, contact the GoodWe After-Sales Service Center.</li> </ol>
36	BMS1 RACK1 Acquisition line fault	Poor contact or disconnection of battery collection line.	Shut down the device, check the wiring, restack the batteries, and restart the device. If the problem persists, please contact GoodWe After-Sales Service Center.

No.	Fault	Cause	Troubleshooting Suggestions:
37	BMS1 RACK1 Relay or MOS temperature is too high fault	Relay or MOS over temperature	<ol style="list-style-type: none"> <li>1. Upgrade the software, shut down the device and leave it idle for 30 minutes, then restart it to see if the fault persists.</li> <li>2. If the fault persists, contact the GoodWe After-Sales Service Center.</li> </ol>
38	BMS1 RACK1 Diverter temperature is too high fault	Diverter over temperature	<ol style="list-style-type: none"> <li>1. Upgrade the software, shut down the device and leave it idle for 30 minutes, then restart it to see if the fault persists.</li> <li>2. If the fault persists, contact the GoodWe After-Sales Service Center.</li> </ol>
39	BMS1 RACK1 Slave MCU communication fault	Loss of communication between master and slave chips	<ol style="list-style-type: none"> <li>1. Check the wiring and restart the battery.</li> <li>2. Upgrade the battery. If the problem persists after restarting, please contact the GoodWe After-Sales Service Center.</li> </ol>
40	BMS1 RACK1 BMU communication fault	Abnormal communication wiring harness between BMS master control and slave control	<ol style="list-style-type: none"> <li>1. Check the wiring and restart the battery.</li> <li>2. Upgrade the battery. If the problem persists after restarting, please contact the GoodWe After-Sales Service Center.</li> </ol>

No.	Fault	Cause	Troubleshooting Suggestions:
41	BMS1 RACK1 Micro-electronics fault	Internal MCU failure	Upgrade the software, restart the battery, and if the problem persists after restarting, please contact the Solid State After-Sales Service Center.
42	BMS1 RACK1 Hardware overcurrent fault	<ol style="list-style-type: none"> <li>1. Software version is too low or BMS board is damaged.</li> <li>2. There are too many inverters connected in parallel, causing excessive impact on the battery during pre-charging.</li> </ol>	<ol style="list-style-type: none"> <li>1. Upgrade the software and observe whether the fault persists.</li> <li>2. If multiple units are connected in parallel, start the battery first, then start the inverter.</li> </ol>
43	BMS1 RACK1 Application software fault	MCU self-test failed	Upgrade the software, restart the battery, and if the problem persists after restarting, please contact the Solid State After-Sales Service Center.
44	BMS1 RACK1 Parallel RACK fault	Communication abnormalities between the master cluster and slave cluster, or inconsistencies between the cells of different clusters.	<ol style="list-style-type: none"> <li>1. Check the battery information and software version of the slave machine, and whether the communication line connection with the host machine is normal.</li> <li>2. Upgrade the software.</li> </ol>

No.	Fault	Cause	Troubleshooting Suggestions:
45	BMS1 RACK1 DCDC fault	DCDC overload or excessive heat sink temperature, etc.	Upgrade the software, restart the battery, and if the problem persists after restarting, please contact the Solid State After-Sales Service Center.
46	BMS1 RACK1 Inconsistent cell fault	1. Battery cell identification error 2. Stacking of different types of battery cells	Check the cell type.
47	BMS1 RACK1 The output port over temperature fault	Loose screws or poor contact at the output port.	1. Turn off the battery, check the wiring and output port screws. 2. After confirmation, restart the battery and observe whether the fault persists. If it does, contact the GoodWe After-Sales Service Center.
48	BMS1 RACK1 SOH too low fault	The battery has been used for too long or the battery cell is severely damaged.	Replace pack
49	BMS1 RACK1 Heating film MOS Three-terminal fault	Heating film mos damaged	Contact the after-sales service.

### 11.5.3 Operation After Fault Clearance

In the energy conservation system, after some fault clearances complete, further operations are needed for the system to restore normal work.

### 11.5.3.1 Clear AFCI Alarm

[Software]: SolarGo App

[Clearance method]:

1. Step 1: Go to the settings page via **Home > Settings > Advanced Settings > DC AFCI** to set up the AFCI detection function.
2. Tap **[Clear AFCI Alarm]**.

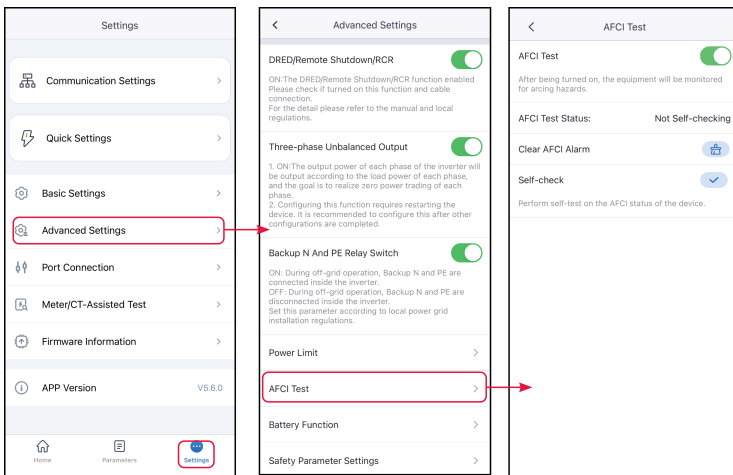

## 12 Technical Parameters

### 12.1 Inverter Parameters

Technical Data	GW3K-EHA-G20	GW3.6K-EHA-G20	GW5K-EHA-G20	GW6K-EHA-G20
Battery Side				
Battery Type* <sup>1</sup>	Li-ion	Li-ion	Li-ion	Li-ion
Nominal Battery Voltage (V)	380	380	380	380
Battery Voltage Range (V)	350~550	350~550	350~550	350~550
Start-up Voltage (V)* <sup>2</sup>	380	380	380	380
Number of Battery Input	1	1	1	1
Max. Continuous Charging Current (A)	11.9	14.3	19.8	23.7
Max. Continuous Discharging Current (A)	8.7	10.5	14.5	17.4
Max. Charging Power (kW)	4.5	5.4	7.5	9
Max. Discharging Power (kW)	3.3	3.96	5.5	6.6

<b>Technical Data</b>	<b>GW3K-EHA-G20</b>	<b>GW3.6K-EHA-G20</b>	<b>GW5K-EHA-G20</b>	<b>GW6K-EHA-G20</b>
PV Side				
Max. Input Power (kW)	6	7.2	10	12
Max. Input Voltage (V) <sup>*3</sup>	600	600	600	600
MPPT Operating Voltage Range (V) <sup>*4</sup>	40~560	40~560	40~560	40~560
MPPT Voltage Range at Nominal Power (V)	150~500	150~500	170~500	210~500
Start-up Voltage (V)	50	50	50	50
Nominal Input Voltage (V)	400	400	400	400
Max. MPPT Current (A)	20	20	20	20
Max. MPPT Short Circuit Current (A)	26	26	26	26
Max. Backfeed Current to The Array (A)	0	0	0	0
Number of MPPTs	2	2	2	2

<b>Technical Data</b>	<b>GW3K-EHA-G20</b>	<b>GW3.6K-EHA-G20</b>	<b>GW5K-EHA-G20</b>	<b>GW6K-EHA-G20</b>
Number of Strings per MPPT	1/1	1/1	1/1	1/1
AC Side (On-grid)				
Nominal Power (kW)	3	3.6	5	6
Nominal Apparent Power to Grid (kVA)	3	3.6	5	6
Max. Apparent Power to Grid (kVA)	3	3.6	5	6
Nominal Apparent Power from Grid (kVA)	3	3.6	5	6
Max. Apparent Power from Grid (kVA) <sup>*6</sup>	6	7.2	10	12
Nominal Voltage (V)	220/230/240, L/N/PE	220/230/240, L/N/PE	220/230/240, L/N/PE	220/230/240, L/N/PE
Voltage Range (V)	170~280	170~280	170~280	170~280
Nominal Frequency (Hz)	50/60	50/60	50/60	50/60
Frequency Range (Hz)	45~55 / 55~65	45~55 / 55~65	45~55 / 55~65	45~55 / 55~65

<b>Technical Data</b>	<b>GW3K-EHA-G20</b>	<b>GW3.6K-EHA-G20</b>	<b>GW5K-EHA-G20</b>	<b>GW6K-EHA-G20</b>
Max. Current to Grid (A)	13.7 at 220V 13.1 at 230V 12.5 at 240V	16.4 at 220V 15.7 at 230V 15 at 240V	22.8 at 220V 21.8 at 230V 20.9 at 240V	27.3 at 220V 26.1 at 230V 25 at 240V
Max. Current From Grid (A)*6	27.3 at 220V 26.1 at 230V 25 at 240V	32.8 at 220V 31.4 at 230V 30 at 240V	45.5 at 220V 43.5 at 230V 41.7 at 240V	50 at 220V 50 at 230V 50 at 240V
Nominal Current From Grid (A)	13.7 at 220V 13.1 at 230V 12.5 at 240V	16.4 at 220V 15.7 at 230V 15 at 240V	22.8 at 220V 21.8 at 230V 20.9 at 240V	27.3 at 220V 26.1 at 230V 25 at 240V
Max. Output Fault Current (Peak and Duration) (A)	96 at 3μs	96 at 3μs	96 at 3μs	96 at 3μs
Inrush Current (Peak and Duration) (A)	96 at 3μs	96 at 3μs	96 at 3μs	96 at 3μs
Nominal Current (A)	13.7 at 220V 13.1 at 230V 12.5 at 240V	16.4 at 220V 15.7 at 230V 15 at 240V	22.8 at 220V 21.8 at 230V 20.9 at 240V	27.3 at 220V 26.1 at 230V 25 at 240V

<b>Technical Data</b>	<b>GW3K-EHA-G20</b>	<b>GW3.6K-EHA-G20</b>	<b>GW5K-EHA-G20</b>	<b>GW6K-EHA-G20</b>
Power Factor	~1 (Adjustable from 0.8 leading to 0.8 lagging)	~1 (Adjustable from 0.8 leading to 0.8 lagging)	~1 (Adjustable from 0.8 leading to 0.8 lagging)	~1 (Adjustable from 0.8 leading to 0.8 lagging)
THDi	<3%	<3%	<3%	<3%
Maximum Output Overcurrent Protection (A)	96	96	96	96
Type of Voltage	a.c.	a.c.	a.c.	a.c.
<b>Back-up Side</b>				
Nominal Output Apparent Power (kVA)	3	3.6	5	6
Max. Output Apparent Power (kVA)	3.0 (6.0, 10s)	3.6 (7.2, 10s)	5.0 (10.0, 10s)	6.0(12.0, 10s)
Max. Output Apparent Power (Bypass) (kVA)	6	7.2	10	12
Nominal Output Current (A)	13.7 at 220V 13.1 at 230V 12.5 at 240V	16.4 at 220V 15.7 at 230V 15 at 240V	22.8 at 220V 21.8 at 230V 20.9 at 240V	27.3 at 220V 26.1 at 230V 25 at 240V

<b>Technical Data</b>	<b>GW3K-EHA-G20</b>	<b>GW3.6K-EHA-G20</b>	<b>GW5K-EHA-G20</b>	<b>GW6K-EHA-G20</b>
Max. Output Current (A) <sup>*5</sup>	13.7 at 220V 13.1 at 230V 12.5 at 240V	16.4 at 220V 15.7 at 230V 15 at 240V	22.8 at 220V 21.8 at 230V 20.9 at 240V	27.3 at 220V 26.1 at 230V 25 at 240V
Max. Output Current (Bypass) (A) <sup>*5</sup>	27.3	32.8	45.5	50
Max. Fault Current (Peak and Duration) (A)	96 at 3μs	96 at 3μs	96 at 3μs	96 at 3μs
Inrush Current (Peak and Duration) (A)	96 at 3μs	96 at 3μs	96 at 3μs	96 at 3μs
Max. Output Overcurrent Protection (A)	96	96	96	96
Nominal Output Voltage (V)	220/230/240, L/N/PE	220/230/240, L/N/PE	220/230/240, L/N/PE	220/230/240, L/N/PE
Nominal Output Frequency (Hz)	50/60	50/60	50/60	50/60
THDv (@Linear Load)	<3%	<3%	<3%	<3%
<b>Efficiency</b>				
Max. Efficiency	97.60%	97.60%	97.60%	97.60%

<b>Technical Data</b>	<b>GW3K-EHA-G20</b>	<b>GW3.6K-EHA-G20</b>	<b>GW5K-EHA-G20</b>	<b>GW6K-EHA-G20</b>
European Efficiency	96.50%	96.50%	96.80%	97.00%
Max. Battery to AC Efficiency	98.00%	98.00%	98.00%	98.00%
<b>Protection</b>				
PV String Current Monitoring	Integrated	Integrated	Integrated	Integrated
PV Insulation Resistance Detection	Integrated	Integrated	Integrated	Integrated
Residual Current Monitoring	Integrated	Integrated	Integrated	Integrated
PV Reverse Polarity Protection	Integrated	Integrated	Integrated	Integrated
Battery Reverse Polarity Protection	Integrated	Integrated	Integrated	Integrated
Anti-islanding Protection	Integrated	Integrated	Integrated	Integrated
AC Overcurrent Protection	Integrated	Integrated	Integrated	Integrated
AC Short Circuit Protection	Integrated	Integrated	Integrated	Integrated

<b>Technical Data</b>	<b>GW3K-EHA-G20</b>	<b>GW3.6K-EHA-G20</b>	<b>GW5K-EHA-G20</b>	<b>GW6K-EHA-G20</b>
AC Overvoltage Protection	Integrated	Integrated	Integrated	Integrated
DC Surge Protection	Type II	Type II	Type II	Type II
AC Surge Protection	Type II	Type II	Type II	Type II
RSD	Optional	Optional	Optional	Optional
AFCI	Integrated	Integrated	Integrated	Integrated
Remote Shutdown	Integrated	Integrated	Integrated	Integrated
<b>General Data</b>				
Operating Temperature Range (°C)	-35~+60 (Derating at +40)	-35~+60 (Derating at +40)	-35~+60 (Derating at +40)	-35~+60 (Derating at +40)
Operating Environment	Outdoor	Outdoor	Outdoor	Outdoor
Relative Humidity	0~95%	0~95%	0~95%	0~95%
Max. Operating Altitude (m)	4000 (>2000 derating)	4000 (>2000 derating)	4000 (>2000 derating)	4000 (>2000 derating)
Cooling Method	Natural convection	Natural convection	Natural convection	Natural convection
User Interface	LED, WLAN+APP	LED, WLAN+APP	LED, WLAN+APP	LED, WLAN+APP

<b>Technical Data</b>	<b>GW3K-EHA-G20</b>	<b>GW3.6K-EHA-G20</b>	<b>GW5K-EHA-G20</b>	<b>GW6K-EHA-G20</b>
Communication with BMS	CAN	CAN	CAN	CAN
Communication	RS485, WiFi+LAN+Bluetooth	RS485, WiFi+LAN+Bluetooth	RS485, WiFi+LAN+Bluetooth	RS485, WiFi+LAN+Bluetooth
Communication Protocols	Modbus-RTU, Modbus-TCP	Modbus-RTU, Modbus-TCP	Modbus-RTU, Modbus-TCP	Modbus-RTU, Modbus-TCP
Weight (kg)	24	24	24	24
Dimension (W×H×D mm)	800*300*270	800*300*270	800*300*270	800*300*270
Noise Emission (dB)	≤30	≤30	≤30	≤30
Topology	Non-isolated	Non-isolated	Non-isolated	Non-isolated
Power Self-consumption at Night (W)	≤10	≤10	≤10	≤10
Ingress Protection Rating	IP66	IP66	IP66	IP66
DC Connector	MC4	MC4	MC4	MC4
AC Connector	plug & play terminal	plug & play terminal	plug & play terminal	plug & play terminal
Environmental Category	4K4H	4K4H	4K4H	4K4H

<b>Technical Data</b>	<b>GW3K-EHA-G20</b>	<b>GW3.6K-EHA-G20</b>	<b>GW5K-EHA-G20</b>	<b>GW6K-EHA-G20</b>
Pollution Degree	III (Outside of the inverter)	III (Outside of the inverter)	III (Outside of the inverter)	III (Outside of the inverter)
Overvoltage Category	DC II / AC III	DC II / AC III	DC II / AC III	DC II / AC III
Protective Class	I	I	I	I
Storage Temperature (°C)	-40~+70	-40~+70	-40~+70	-40~+70
Decisive Voltage Class (DVC)	Battery: A PV: C AC: C Com: A	Battery: A PV: C AC: C Com: A	Battery: A PV: C AC: C Com: A	Battery: A PV: C AC: C Com: A
Mounting Method	Wall/Floor Mounted	Wall/Floor Mounted	Wall/Floor Mounted	Wall/Floor Mounted
Active Anti-islanding Method	SMS(Slip-mode frequency) +AFD	SMS(Slip-mode frequency) +AFD	SMS(Slip-mode frequency) +AFD	SMS(Slip-mode frequency) +AFD
Country of Manufacture	China	China	China	China
<b>Certification</b>				
Grid Standard	IEC/EN 61000-6-1/-2/-3/-4, IEC/EN 62920, CISPR 11, EN 55011, AS/NZS 61000.6.3/.4, AS 61000.6.4			
Safety Regulation	IEC62109-1/-2, IEC 63037			
EMC	IEC/EN 61000-6-1/-2/-3/-4			

Technical Data	GW8K-EHA-G20	GW9.999K-EHA-G20	GW10K-EHA-G20
Battery Side			
Battery Type <sup>*1</sup>	Li-ion	Li-ion	Li-ion
Nominal Battery Voltage (V)	380	380	380
Battery Voltage Range (V)	350~550	350~550	350~550
Start-up Voltage (V) <sup>*2</sup>	380	380	380
Number of Battery Input	1	1	1
Max. Continuous Charging Current (A)	31.6	35.6	35.6
Max. Continuous Discharging Current (A)	23.2	29	29
Max. Charging Power (kW)	12	13.5	13.5
Max. Discharging Power (kW)	8.8	11	11
PV Side			
Max. Input Power (kW)	16	20	20
Max. Input Voltage (V) <sup>*3</sup>	600	600	600

<b>Technical Data</b>	<b>GW8K-EHA-G20</b>	<b>GW9.999K-EHA-G20</b>	<b>GW10K-EHA-G20</b>
MPPT Operating Voltage Range (V) <sup>*4</sup>	40~560	40~560	40~560
MPPT Voltage Range at Nominal Power (V)	170~500	190~500	190~500
Start-up Voltage (V)	50	50	50
Nominal Input Voltage (V)	400	400	400
Max. MPPT Current (A)	20	20	20
Max. MPPT Short Circuit Current (A)	26	26	26
Max. Backfeed Current to The Array (A)	0	0	0
Number of MPPTs	4	4	4
Number of Strings per MPPT	1/1/1/1	1/1/1/1	1/1/1/1
<b>AC Side (On-grid)</b>			
Nominal Power (kW)	8	9.999	10
Nominal Apparent Power to Grid (kVA)	8	9.999	10
Max. Apparent Power to Grid (kVA)	8	9.999	10

<b>Technical Data</b>	<b>GW8K-EHA-G20</b>	<b>GW9.999K-EHA-G20</b>	<b>GW10K-EHA-G20</b>
Nominal Apparent Power from Grid (kVA)	8	9.999	10
Max. Apparent Power from Grid (kVA) <sup>*6</sup>	14.5	14.5	14.5
Nominal Voltage (V)	220/230/240, L/N/PE	220/230/240, L/N/PE	220/230/240, L/N/PE
Voltage Range (V)	170~280	170~280	170~280
Nominal Frequency (Hz)	50/60	50/60	50/60
Frequency Range (Hz)	45~55 / 55~65	45~55 / 55~65	45~55 / 55~65
Max. Current to Grid (A)	36.4 at 220V 34.8 at 230V 33.4 at 240V	43.5 at 220V 43.5 at 230V 41.7 at 240V	43.5 at 220V 43.5 at 230V 41.7 at 240V
Max. Current From Grid (A) <sup>*6</sup>	63 at 220V 63 at 230V 60.5 at 240V	63 at 220V 63 at 230V 60.5 at 240V	63 at 220V 63 at 230V 60.5 at 240V
Nominal Current From Grid (A)	36.4 at 220V 34.8 at 230V 33.4 at 240V	45.5 at 220V 43.5 at 230V 41.7 at 240V	45.5 at 220V 43.5 at 230V 41.7 at 240V

<b>Technical Data</b>	<b>GW8K-EHA-G20</b>	<b>GW9.999K-EHA-G20</b>	<b>GW10K-EHA-G20</b>
Max. Output Fault Current (Peak and Duration) (A)	120 at 3μs	120 at 3μs	120 at 3μs
Inrush Current (Peak and Duration) (A)	120 at 3μs	120 at 3μs	120 at 3μs
Nominal Current (A)	36.4 at 220V 34.8 at 230V 33.4 at 240V	43.5 at 220V 43.5 at 230V 41.7 at 240V	43.5 at 220V 43.5 at 230V 41.7 at 240V
Power Factor	~1 (Adjustable from 0.8 leading to 0.8 lagging)	~1 (Adjustable from 0.8 leading to 0.8 lagging)	~1 (Adjustable from 0.8 leading to 0.8 lagging)
THDi	<3%	<3%	<3%
Maximum Output Overcurrent Protection (A)	120	120	120
Type of Voltage	a.c.	a.c.	a.c.
<b>Back-up Side</b>			
Nominal Output Apparent Power (kVA)	8	10	10
Max. Output Apparent Power (kVA)	8.0(16.0, 10s)	10.0(20.0, 10s)	10.0(20.0, 10s)

<b>Technical Data</b>	<b>GW8K-EHA-G20</b>	<b>GW9.999K-EHA-G20</b>	<b>GW10K-EHA-G20</b>
Max. Output Apparent Power (Bypass) (kVA)	14.5	14.5	14.5
Nominal Output Current (A)	36.4 at 220V 34.8 at 230V 33.4 at 240V	43.5 at 220V 43.5 at 230V 41.7 at 240V	43.5 at 220V 43.5 at 230V 41.7 at 240V
Max. Output Current (A) <sup>*5</sup>	36.4 at 220V 34.8 at 230V 33.4 at 240V	43.5 at 220V 43.5 at 230V 41.7 at 240V	43.5 at 220V 43.5 at 230V 41.7 at 240V
Max. Output Current (Bypass) (A) <sup>*5</sup>	63	63	63
Max. Fault Current (Peak and Duration) (A)	120 at 3μs	120 at 3μs	120 at 3μs
Inrush Current (Peak and Duration) (A)	120 at 3μs	120 at 3μs	120 at 3μs
Max. Output Overcurrent Protection (A)	120	120	120
Nominal Output Voltage (V)	220/230/240, L/N/PE	220/230/240, L/N/PE	220/230/240, L/N/PE
Nominal Output Frequency (Hz)	50/60	50/60	50/60

<b>Technical Data</b>	<b>GW8K-EHA-G20</b>	<b>GW9.999K-EHA-G20</b>	<b>GW10K-EHA-G20</b>
THDv (@Linear Load)	<3%	<3%	<3%
Efficiency			
Max. Efficiency	97.50%	97.50%	97.50%
European Efficiency	96.80%	96.80%	96.80%
Max. Battery to AC Efficiency	97.80%	97.80%	97.80%
Protection			
PV String Current Monitoring	Integrated	Integrated	Integrated
PV Insulation Resistance Detection	Integrated	Integrated	Integrated
Residual Current Monitoring	Integrated	Integrated	Integrated
PV Reverse Polarity Protection	Integrated	Integrated	Integrated
Battery Reverse Polarity Protection	Integrated	Integrated	Integrated
Anti-islanding Protection	Integrated	Integrated	Integrated
AC Overcurrent Protection	Integrated	Integrated	Integrated
AC Short Circuit Protection	Integrated	Integrated	Integrated

<b>Technical Data</b>	<b>GW8K-EHA-G20</b>	<b>GW9.999K-EHA-G20</b>	<b>GW10K-EHA-G20</b>
AC Overvoltage Protection	Integrated	Integrated	Integrated
DC Surge Protection	Type II	Type II	Type II
AC Surge Protection	Type II	Type II	Type II
RSD	Optional	Optional	Optional
AFCI	Integrated	Integrated	Integrated
Remote Shutdown	Integrated	Integrated	Integrated
<b>General Data</b>			
Operating Temperature Range (°C)	-35~+60 (Derating at +40)	-35~+60 (Derating at +40)	-35~+60 (Derating at +40)
Operating Environment	Outdoor	Outdoor	Outdoor
Relative Humidity	0~95%	0~95%	0~95%
Max. Operating Altitude (m)	4000 (>2000 derating)	4000 (>2000 derating)	4000 (>2000 derating)
Cooling Method	Natural convection	Natural convection	Natural convection
User Interface	LED, WLAN+APP	LED, WLAN+APP	LED, WLAN+APP
Communication with BMS	CAN	CAN	CAN
Communication	RS485, WiFi+LAN+Bluetooth	RS485, WiFi+LAN+Bluetooth	RS485, WiFi+LAN+Bluetooth

<b>Technical Data</b>	<b>GW8K-EHA-G20</b>	<b>GW9.999K-EHA-G20</b>	<b>GW10K-EHA-G20</b>
Communication Protocols	Modbus-RTU, Modbus-TCP	Modbus-RTU, Modbus-TCP	Modbus-RTU, Modbus-TCP
Weight (kg)	26	26	26
Dimension (W×H×D mm)	800*300*270	800*300*270	800*300*270
Noise Emission (dB)	≤35	≤35	≤35
Topology	Non-isolated	Non-isolated	Non-isolated
Power Self-consumption at Night (W)	≤10	≤10	≤10
Ingress Protection Rating	IP66	IP66	IP66
DC Connector	MC4	MC4	MC4
AC Connector	plug & play terminal	plug & play terminal	plug & play terminal
Environmental Category	4K4H	4K4H	4K4H
Pollution Degree	III (Outside of the inverter)	III (Outside of the inverter)	III (Outside of the inverter)
Overvoltage Category	DC II / AC III	DC II / AC III	DC II / AC III
Protective Class	I	I	I

Technical Data	GW8K-EHA-G20	GW9.999K-EHA-G20	GW10K-EHA-G20
Storage Temperature (°C)	-40~+70	-40~+70	-40~+70
Decisive Voltage Class (DVC)	Battery: A PV: C AC: C Com: A	Battery: A PV: C AC: C Com: A	Battery: A PV: C AC: C Com: A
Mounting Method	Wall/Floor Mounted	Wall/Floor Mounted	Wall/Floor Mounted
Active Anti-islanding Method	SMS(Slip-mode frequency) +AFD	SMS(Slip-mode frequency) +AFD	SMS(Slip-mode frequency) +AFD
Country of Manufacture	China	China	China
Certification			
Grid Standard	IEC/EN 61000-6-1/-2/-3/-4, IEC/EN 62920, CISPR 11, EN 55011, AS/NZS 61000.6.3/.4, AS 61000.6.4		
Safety Regulation	IEC62109-1/-2, IEC 63037		
EMC	IEC/EN 61000-6-1/-2/-3/-4		

\*1: The Li-Ion battery usually contain two mainstream type: LFP and Ternary Lithium battery.

\*2: If there's no PV, start-up voltage will be 380V.

\*3: When the input voltage is 560V-600V, the inverter will enter standby mode, and the voltage returns to 560V to enter the normal operation state.

\*4: Please refer to the user manual for the MPPT Voltage Range at Nominal Power.

\*5: If the Back-up port is not used, select an appropriate circuit breaker based on the AC Max. Output Current.

\*6: GOODWE ESA series has internal bypass 63A passthrough ability to support whole home backup solution. If the customer don't want to do any breaker upgrade, the main breaker size in SolarGo(or SEMS+) can be set as previous breaker size.

## 12.2 Battery Technical Data

Technical Data	GW5.1-BAT-D-G20	GW8.3-BAT-D-G20	GW5.1-BAT-D-G21	GW8.3-BAT-D-G21
Rated Energy (kWh)	5.12	8.32	5.12	8.32
Usable Energy (kWh)*1	5	8	5	8
Battery Type	LFP (LiFePO <sub>4</sub> )			
Operating Voltage Range (V) (single phase system)	350~550			
Operating Voltage Range (V) (three phase system)	700~950			
Max. Input Current (System) (A)	12	19	12	19
Max. Output Current (System) (A)	13.2	21	13.2	21
Max. Input Power (System) (kW)*2	5	8	5	8
Max. Output Power (System) (kW)*2	5	8	5	8
Peak Output Power (System) (kW)*2	7.5 @10s	12 @10s	7.5 @10s	12 @10s
Charging Temperature Range (°C)	-18~55		2~55	
Discharging Temperature Range (°C)	-20~55		-20~55	
Relative Humidity	5-95%			
Max. Operating Altitude (m)	4000			

Technical Data		GW5.1-BAT-D-G20	GW8.3-BAT-D-G20	GW5.1-BAT-D-G21	GW8.3-BAT-D-G21
Noise Emission (dB)		≤29			
Communication		CAN			
Weight (kg)		57.5±1	79±1	57.5±1	79±1
Dimensions (W×H×D mm)		800*326*270			
Optional Function Configuration		heating		/	
Ingress Protection		IP66			
Storage Temperature (°C)		-20 ~55			
Max. Storage time		12 months (-20°C~35°C)			
		6 months (35°C~45°C)			
Scalability		6 pcs			
Mounting Method		Floor stacked / Wall-mounted			
Cycle Life		≥6000 (25±2°C 0.5C 90%DOD 70%EOL)			
Country of Manufacture		China			
Standard and Certification	Safety	IEC62619, IEC60730, EN62477, IEC63056, IEC62040, CE, CEC			
	EMC	CE, RCM			
	Transportation	UN38.3 ADR			

\*1: Test conditions, 100% DOD (cell 2.85~3.6V voltage range), 0.2P charge & discharge at 25±2 °C for battery system at the beginning of life. Usable energy is defined by its initial design value. Actual available energy may vary depending on charge/discharge rate, environmental conditions (e.g. temperature), transport and storage factors.

\*2: Max. Input Power /Max. Output Power/Peak.Output Power derating will occur related to Temperature and

SOC.

## 12.3 Smart Meter Technical Data

### 12.3.1 GMK110

Technical Parameters		GMK110	
	Application	Single phase	
Input Data	Voltage	Nominal Voltage (V)	220
		Voltage Range (V)	85~288
		Nominal Voltage Frequency (Hz)	50/60
	Current	CT Ratio	120A/40mA
		CT Quantity	1
Communication		RS485	
Communication Distance (m)		1000	
User Interface		2LED	
Accuracy	Voltage/Current	Class I	
	Active Energy	Class I	
	Reactive Energy	Class II	
Power Consumption (w)		<5	
Mechanical Parameters	Dimension (W×H×D mm)	19*85*67	
	Weight (g)	50	
	Mounting Method	Rail Installation	
Environmental Parameters	Ingress Protection Rating	IP20	
	Operating Temperature Range (°C)	-30~ 60	
	Storage Temperature Range (°C)	-30~ 60	
	Relative Humidity (Non-Condensing)	0~95%	
	Max. Operating Altitude (m)	3000	

### 12.3.2 GM330

Technical Parameters		GM330
Measuring Range	Support Grid Type	Three-phase, split-phase, single-phase
	Voltage Range L-N (Vac)	172~817
	Voltage Range L-L (Vac)	100~472
	Nominal Frequency (Hz)	50/60
	CT Ratio	nA:5A
Communication Parameters	Communication Method	RS485
	Communication Distance (m/ft)	1000/3280
Precision Accuracy	Voltage/Current	Class 0.5
	Active Energy	Class 0.5
	Reactive Energy	Class 1
General Data	Dimension (WxHxDmm/in)	72x85x72/2.83x3.35x2.83
	Housing	4 modules
	Weight (g/lb)	240/0.53
	Mounting Method	DIN rail
	User Interface	4 LEDs, Reset Button
	Power Consumption (w)	<5
Environmental Parameters	Ingress Protection Rating	IP20
	Operating Temperature Range (°C/°F)	-30~+70/-22~+158
	Storage Temperature Range (°C/°F)	-30~70/-22~+158
	Relative Humidity (No Condensing)	0~95%
	Max. Operating Altitude (m/ft)	3000/9842
Certification Parameters	Certificate	UL1741/ANSI

## 12.4 Smart Dongle Technical Data

### 12.4.1 WiFi/LAN Kit-20

Technical Parameters		WiFi/LAN Kit-20
Output Voltage (V)		5
Power Consumption (W)		<=2
Communication Port		USB
Communication Parameters	Ethernet	10M/100Mbps Self-adaptation
	Wireless	IEEE 802.11 b/g/n @2.4 GHz
	Bluetooth	Bluetooth V4.2 BR/EDR and Bluetooth LE Standard
Mechanical Parameters	Dimension (W×H×D mm)	48.3*159.5*32.1
	Weight (g)	82
	Ingress Protection Rating	IP65
	Mounting Method	USB Port Plugging and Unplugging
Operating Temperature Range (°C)		-30~+60
Storage Temperature Range (°C)		-40~+70
Relative Humidity		0-95%
Max. Operating Altitude (m)		4000

#### 12.4.2 4G Kit-CN-G20

Product Model	4G Kit-CN-G20
Device Management	
Maximum Supported Number of Inverters	1
Power Parameter	
Input Voltage (V)	5
Power Consumption (W)	<=4
Interface Method	USB
Communication Parameters	
4G/3G/2G	LTE-FDD : B1/B3/B5/B8 LTE-TDD : B34/B39/B40/B41
GNSS Location	/
Bluetooth	Bluetooth V5.0
Mechanical Parameters	
Dimension (W×H×D mm)	48.3*95.5*32.1
Weight (g)	87
Indicator	LED* 2

<b>Product Model</b>	<b>4G Kit-CN-G20</b>
Mounting Method	Plug and Play (PnP)
SIM Dimension	Micro sim,15mm*12mm
Environment Parameters	
Operating Temperature Range (°C)	-30~+65
Storage Temperature (°C)	-40~+70
Relative Humidity	0-100%
IP Grade	IP66
Max. Operating Altitude (m)	4000
Safe Service Life (Year)	5

## 13 Appendix

### 13.1 FAQ

#### 13.1.1 How to Conduct Auxiliary Detection for Smart Meters/CT?

Meter detection function, which can detect whether the CT of the meter is connected correctly and the current operation status of the meter and CT.

- Approach 1:

1. Access the detection page through **Home > Settings > Electricity Meter/ CT Auxiliary Detection**.
2. Click "Start Detection" and wait for the detection to complete. Then, view the detection results.

- Approach 2:

1. Access the detection  page through > **[System Setup] > [Quick Setting] > [Meter/CT Assisted Test]**.
2. Click "Start Detection" and wait for the detection to complete. Then, view the detection results.

#### 13.1.2 How to Upgrade the Device Version

Through the firmware information, you can view or upgrade the DSP version, ARM version, BMS version, and smart dongle software version of the inverter. Some smart dongles do not support software version upgrade via SolarGo App, and the actual situation shall prevail.

- **Upgrade prompt:**

When the user opens the APP, an upgrade prompt will pop up on the homepage, and the user can choose whether to upgrade or not. If you choose to upgrade, you can complete the upgrade by following the prompts on the interface.

- **Regular upgrade:**

**Access the firmware information viewing interface through "Home" > "Settings" > "Firmware Information"**

Click "Check for Updates". If there is a new version, complete the upgrade according to the prompts on the interface.

- **Forced Upgrade:**

The APP will push upgrade information, and users need to upgrade according to the prompts to continue using the app. You can complete the upgrade by following the prompts on the interface.

### **Inverter Software Version Upgrade**

- To connect USB flash drive for local software upgrading.
- Before upgrading the device using a USB flash drive, please contact the after-sales service center to obtain the software upgrade package and upgrade method.

## **13.2 Abbreviations**

<b>Abbreviation</b>	<b>English Description</b>	<b>Chinese Description</b>
Ubatt	Battery Voltage Range	电池电压范围
Ubatt,r	Nominal Battery Voltage	额定电池电压
Ibatt,max (C/D)	Max. Charging Current Max. Discharging Current	最大充/放电电流
EC,R	Rated Energy	额定能量
UDCmax	Max.Input Voltage	最大输入电压
UMPP	MPPT Operating Voltage Range	MPPT 电压范围
IDC,max	Max. Input Current per MPPT	每路 MPPT 最大输入电流
ISC PV	Max. Short Circuit Current per MPPT	每路 MPPT 最大短路电流
PAC,r	Nominal Output Power	Nominal Output Power
Sr (to grid)	Nominal Apparent Power Output to Utility Grid	额定并网输出视在功率
Smax (to grid)	Max. Apparent Power Output to Utility Grid	最大并网输出视在功率
Sr (from grid)	Nominal Apparent Power from Utility Grid	从电网买电额定输出视在功率
Smax (from grid)	Max. Apparent Power from Utility Grid	从电网买电最大输出视在功率
UAC,r	Nominal Output Voltage	Nominal Output Voltage

Abbreviation	English Description	Chinese Description
fAC,r	Nominal AC Grid Frequency	输出电压频率
IAC,max(to grid)	Max. AC Current Output to Utility Grid	最大并网输出电流
IAC,max(from grid)	Max. AC Current From Utility Grid	最大输入电流
P.F.	Power Factor	Power Factor
Sr	Back-up Nominal apparent power	离网额定视在功率
Smax	Max. Output Apparent Power (VA) Max. Output Apparent Power without Grid	最大输出视在功率
IAC,max	Max. Output Current	最大输出电流
UAC,r	Nominal Output Voltage	最大输出电压
fAC,r	Nominal Output Frequency	额定输出电压频率
Toperating	Operating Temperature Range	工作温度范围
IDC,max	Max. Input Current	最大输入电流
UDC	Input Voltage	输入电压
UDC,r	DC Power Supply	直流输入
UAC	Power Supply/AC Power Supply	输入电压范围/交流输入
UAC,r	Power Supply/Input Voltage Range	输入电压范围/交流输入
Toperating	Operating Temperature Range	工作温度范围
Pmax	Max Output Power	最大功率
PRF	TX Power	发射功率
PD	Power Consumption	功耗
PAC,r	Power Consumption	功耗
F (Hz)	Frequency	频率
ISC PV	Max. Input Short Circuit Current	最大输入短路电流
Udcmin-Udcmax	Range of input Operating Voltage	工作电压范围
UAC,rang(L-N)	Power Supply Input Voltage	适配器输入电压范围
Usys,max	Max System Voltage	最大系统电压

Abbreviation	English Description	Chinese Description
Haltitude,max	Max. Operating Altitude	最高工作海拔高度
PF	Power Factor	Power Factor
THDi	Total Harmonic Distortion of Current	电流谐波
THDv	Total Harmonic Distortion of Voltage	电压谐波
C&I	Commercial & Industrial	工商业
SEMS	Smart Energy Management System	智慧能源管理系统
MPPT	Maximum Power Point Tracking	最大功率点跟踪
PID	Potential-Induced Degradation	电位诱发衰减
Voc	Open-Circuit Voltage	开路电压
Anti PID	Anti-PID	防PID
PID Recovery	PID Recovery	PID修复
PLC	Power-line Commucation	电力线载波通信
Modbus TCP/IP	Modbus Transmission Control / Internet Protocol	基于TCP/IP层的modbus
Modbus RTU	Modbus Remote Terminal Unit	基于串行链路的modbus
SCR	Short-Circuit Ratio	短路比
UPS	Uninterruptable Power Supply	不间断电源
ECO mode	Economical Mode	经济模式
TOU	Time of Use	使用时间
ESS	Energy Stroage System	储能系统
PCS	Power Conversion System	电能转换系统
RSD	Rapid shutdown	Rapid Shutdown
EPO	Emergency Power Off	紧急关断
SPD	Surge Protection Device	防雷保护
ARC	zero injection/zero export Power Limit / Export Power Limit	防逆流
DRED	Demand Response Enabling Device	命令响应设备
RCR	Ripple Control Receiver	-
AFCI	AFCI	AFCI直流拉弧保护

Abbreviation	English Description	Chinese Description
GFCI	Ground Fault Circuit Interrupter	接地故障断路器
RCMU	Residual Current Monitoring Unit	残余电流监控装置
FRT	Fault Ride Through	故障穿越
HVRT	High Voltage Ride Through	高电压穿越
LVRT	Low Voltage Ride Through	低电压穿越
EMS	Energy Management System	能量管理系统
BMS	Battery Management System	电池管理系统
BMU	Battery Measure Unit	电池采集单元
BCU	Battery Control Unit	电池控制单元
SOC	State of Charge	电池的荷电状态
SOH	State of Health	电池健康度
SOE	State Of Energy	电池剩余能量
SOP	State Of Power	电池充放电能力
SOF	State Of Function	电池的功能状态
SOS	State Of Safety	安全状态
DOD	Depth of discharge	放电深度

### 13.3 Explanation of Terms

- **Overvoltage Category Definition**

- **Category I:** applies to equipment connected to a circuit where measures have been taken to reduce transient overvoltage to a low level.
- **Category II:** applies to fixed downstream equipment. For example, appliances, portable tools and other plug-connected equipment; Voltage category III is used if there are special requirements for the reliability and suitability of such equipment.
- **Category III:** applies to fixed downstream equipment, including the main distribution board. For example, switchgear and other equipment in an industrial installation
- **Category IV:** applies to the upstream equipment in the power supply of the distribution device, including measuring instruments and upstream over-current protection devices.

- **Definition of Types of Damp Places**

Environmental Parameters	Level		
	3K3	4K2	4K4H
Temperature Range	0~+40°C	-33~+40°C	-33~+40°C
Humidity Range	5% to 85%	5% to 85%	5% to 85%

- **Definition of Environmental Category:**
  - **Outdoor Inverter:** The ambient air temperature range is -25 to +60°C, and it is suitable for environments with pollution degree 3.
  - **Indoor Type II Inverter:** The ambient air temperature range is -25 to +40°C, and it is suitable for environments with pollution degree 3.
  - **Indoor Type I Inverter:** The ambient air temperature range is 0 to +40°C, and it is suitable for environments with pollution degree 2.
- **Definition of Pollution Degree Categories:**
  - **Pollution Degree 1:** No pollution or only dry non-conductive pollution.
  - **Pollution Degree 2:** In general, there is only non-conductive pollution, but the transient conductive pollution caused by occasional condensation must be taken into account.
  - **Pollution Degree 3:** There is conductive pollution, or the non-conductive pollution becomes conductive pollution due to condensation.
  - **Pollution Degree 4:** Persistent conductive pollution, such as pollution caused by conductive dust or rain and snow.

### 13.4 Battery SN Code Meaning

\*\*\*\*\*2388\*\*\*\*\*



The 11th-14th digits

LXD10DSC0002

Bits 11-14 of the product SN code are the production time code.  
The above picture has a production date of 2023-08-08

- The 11th and 12th digits represent the last two digits of the year of manufacture,

e.g., 2023 is represented by 23.

- The 13th digit is the month of production, e.g., August is represented by 8; as follows:

Month	1~9	10	11	12
Month	1~9	A	B	C

- The 14th digit is the date of production, e.g., the 8th day is indicated by 8; priority is given to the use of numerical representation, e.g., 1~9 indicates the 1st~9th day, A indicates the 10th day, and so on. The letters I and O are not used to avoid confusion. The details are as follows:

Production Date	1	2	3	4	5	6	7	8	9
Code	1	2	3	4	5	6	7	8	9

Production Date	10	11	12	13	14	15	16	17	18
Code	A	B	C	D	E	F	G	H	J

Production Date	21	22	23	24	25	26	27	28	29
Code	M	N	P	Q	R	S	T	U	V

## 13.5 Safety Country

No.	Safety Code	No.	Safety Code
Europe			
1	IT-CEI 0-21	43	CZ-C
2	IT-CEI 0-16	44	CZ-D
3	DE LV with PV	45	RO-A
4	DE LV without PV	46	RO-B
5	DE-MV	47	RO-D
6	ES-A	48	GB-G98
7	ES-B	49	GB-G99-A
8	ES-C	50	GB-G99-B

No.	Safety Code	No.	Safety Code
9	ES-D	51	GB-G99-C
10	ES-island	52	GB-G99-D
11	BE	53	NI-G98
12	FR	54	IE-16/25A
13	FR-island-50Hz	55	IE-72A
14	FR-island-60Hz	56	IE-ESB
15	PL-A	57	IE-EirGrid
16	PL-B	58	PT-D
17	PL-C	59	EE
18	PL-D	60	NO
19	NL-16/20A	61	FI-A
20	NL-A	62	FI-B
21	NL-B	63	FI-C
22	NL-C	64	FI-D
23	NL-D	65	UA-A1
24	SE-A	66	UA-A2
25	SE MV	67	EN 50549-1
26	SK-A	68	EN 50549-2
27	SK-B	69	DK-West-B-MVHV
28	SK-C	70	DK-East-B-MVHV
29	HU	71	DK-West-C-MVHV
30	CH	72	DK-East-C-MVHV
31	CY	73	DK-West-D-MVHV
32	GR	74	DK-East-D-MVHV
33	DK-West-A	75	FR-Reunion
34	DK-East-A	76	BE-LV (>30kVA)
35	DK-West-B	77	BE-HV
36	DK-East-B	78	CH-B
37	AT-A	79	NI-G99-A
38	AT-B	80	NI-G99-B
39	BG	81	NI-G99-C

No.	Safety Code	No.	Safety Code
40	CZ-A-09	82	NI-G99-D
41	CZ-B1-09	83	IE-LV
42	CZ-B2-09	84	IE-MV
<b>Globe</b>			
1	60Hz-Default	5	IEC 61727-50Hz
2	50Hz-Default	6	IEC 61727-60Hz
3	127Vac-60Hz-Default	7	Warehouse
4	127Vac-50Hz-Default		
<b>America</b>			
1	Argntina	30	US-ISO-NE-480Vac
2	US-208Vac	31	US-ISO-NE-208Vac-3P
3	US-240Vac	32	US-ISO-NE-220Vac-3P
4	Mexico-220Vac	33	US-ISO-NE-240Vac-3P
5	Mexico-440Vac	34	PR-208Vac
6	US-480Vac	35	PR-240Vac
7	US-208Vac-3P	36	PR-480 Vac
8	US-220Vac-3P	37	PR-208Vac-3P
9	US-240Vac-3P	38	PR-220Vac-3P
10	US-CA-208Vac	39	PR-240Vac-3P
11	US-CA-240Vac	40	Cayman
12	US-CA-480Vac	41	Brazil-220Vac
13	US-CA-208Vac-3P	42	Brazil-208Vac
14	US-CA-220Vac-3P	43	Brazil-230Vac
15	US-CA-240Vac-3P	44	Brazil-240Vac
16	US-HI-208Vac	45	Brazil-254Vac
17	US-HI-240Vac	46	Brazil-127Vac
18	US-HI-480Vac	47	Brazil-ONS
19	US-HI-208Vac-3P	48	Barbados
20	US-HI-220Vac-3P	49	Chile-BT
21	US-HI-240Vac-3P	50	Chile-MT
22	US-Kauai-208Vac	51	Colombia

No.	Safety Code	No.	Safety Code
23	US-Kauai-240Vac	52	Colombia<0.25MW 1P
24	US-Kauai-480Vac	53	Colombia<0.25MW 3P
25	US-Kauai-208Vac-3P	54	IEEE 1547-208Vac
26	US-Kauai-220Vac-3P	55	IEEE 1547-20Vac
27	US-Kauai-240Vac-3P	56	IEEE 1547-240Vac
28	US-ISO-NE-208Vac	57	IEEE 1547-230/400Vac
29	US-ISO-NE-240Vac		
<b>Oceania</b>			
1	Australia-A	4	Newzealand
2	Australia-B	5	Newzealand:2015
3	Australia-C	6	NZ-GreGrid
<b>Asia</b>			
1	China A	25	JP-420Vac-50Hz
2	China B	26	JP-420Vac-60Hz
3	China's high pressure	27	JP-480Vac-50Hz
4	China's highest pressure	28	JP-480Vac-60Hz
5	China Power Station	29	Sri Lanka
6	China 242 Shandong	30	Singapore
7	China 242 Hebei	31	Israel-OG
8	China PCS	32	Israel-LV
9	Taiwan	33	Israel-MV
10	Hongkong	34	Israel-HV
11	China 242 Northeast	35	Vietnam
12	Thailand-MEA	36	Malaysia-LV
13	Thailand-PEA	37	Malaysia-MV
14	Mauritius	38	DEWA-LV
15	Korea	39	DEWA-MV
16	India	40	Saudi Arabia
17	India-CEA	41	JP-690Vac-50Hz
18	Pakistan	42	JP-690Vac-60Hz

No.	Safety Code	No.	Safety Code
19	Philippines	43	Srilanka
20	Philippines-127Vac	44	IEC 61727-127Vac-50Hz
21	JP-50Hz	45	IEC 61727-127Vac-60Hz
22	JP-60Hz	46	JP-550Vac-50Hz
23	JP-440Vac-50Hz	47	JP-550Vac-60Hz
24	JP-440Vac-60Hz	48	India-Higher
Africa			
1	South Africa-LV	4	Ghana
2	South Africa-B-MV	5	Ghana-HV
3	South Africa-C-MV		

## 13.6 Australia Safety Regulations

For the Australian market, to comply with AS/NZS 4777.2:2020, please select from Australia A, Australia B, Australia C, or New Zealand. Please contact your local electricity grid operator on which Region to select.

Selecting a Region B should then automatically load all region B setpoints for volt-watt, volt-var, underfrequency, overfrequency, etc.

### Volt-var response set-point values

Region	Default value	U1	U2	U3	U4
Australia A	Voltage	207V	220V	240V	258V
	Inverter reactive power level (Q) % of $S_{rated}$	44 % supplying	0%	0%	60 % absorbing
Australia B	Voltage	205V	220V	235V	255V
	Inverter reactive power level (Q) % of $S_{rated}$	30 % supplying	0%	0%	40 % absorbing
Australia C	Voltage	215V	230V	240V	255V

Region	Default value	U1	U2	U3	U4
	Inverter reactive power level (Q) % of $S_{rated}$	44 % supplying	0%	0%	60 % absorbing
New Zealand	Voltage	207V	220V	235V	244 V
	Inverter reactive power level (Q) % of $S_{rated}$	60 % supplying	0%	0%	60 % absorbing
Allowed range	Voltage	180 to 230 V	180 to 230 V	230 to 265 V	230 to 265 V
	Inverter reactive power level (Q) % of $S_{rated}$	30 to 60 % supplying	0%	0%	30 to 60 % absorbing

NOTE 1: Inverters may operate at a reactive power level with a range up to 100 % supplying or absorbing.

NOTE 2: Australia C parameter set is intended for application in isolated or remote power systems.

### Volt-watt response default set-point values

Region	Default value	U3	U4
Australia A	Voltage	253V	260V
	Inverter maximum active power output level (P) % of $S_{rated}$	100%	20%
Australia B	Voltage	250V	260V
	Inverter maximum active power output level (P) % of $S_{rated}$	100%	20%
Australia C	Voltage	253V	260V

Region	Default value	U3	U4
	Inverter maximum active power output level (P) % of $S_{rated}$	100%	20%
New Zealand	Voltage	242 V	250V
	Inverter maximum active power output level (P) % of $S_{rated}$	100%	20%
Allowed range	Voltage	235 to 255 V	240 to 265 V
	Inverter maximum active power output level (P) % of $S_{rated}$	100%	20%

NOTE: Australia C parameter set is intended for application in isolated or remote power systems.

### Passive anti-islanding voltage limit values

Protective function	Protective function limit	Trip delay time	Maximum disconnection time
Undervoltage 2 (V << )	70 V	1 s	2 s
Undervoltage 1 (V < )	180 V	10 s	11 s
Overvoltage 1 (V > )	265 V	1 s	2 s
Overvoltage 2 (V >> )	275V	-	0.2 s

### Upper connection and reconnection frequency ( $f_{URF}$ )

Region	$f_{URF}$
Australia A	50.15 Hz

Australia B	50.15 Hz
Australia C	50.50 Hz
New Zealand	50.15 Hz

**Setting steps:**

**Step 1:** Set the safety code to Australia A/B/C/New Zealand on Quick Settings page based on actual needs.

**Step 2:** Set the frequency parameters accordingly.

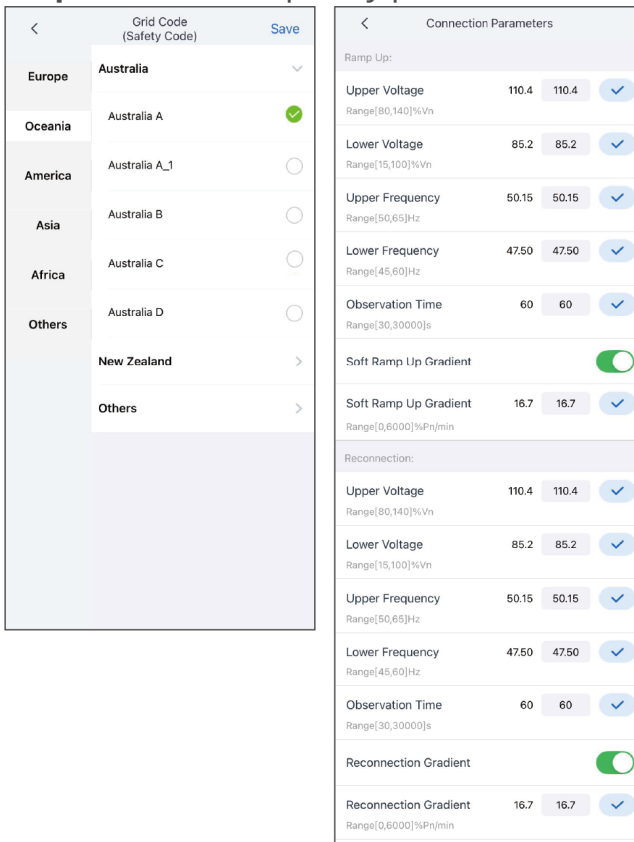

SLG00CON0144

Grid Code (Safety Code) Save

- Europe **Australia** ▾
- Oceania Australia A ○
- America Australia A\_1 ○
- Asia **Australia B** ✓
- Africa Australia C ○
- Others Australia D ○
- New Zealand >
- Others >

Connection Parameters

Ramp Up:

Upper Voltage 110.4 110.4 ✓  
Range[80,140]%Vn

Lower Voltage 85.2 85.2 ✓  
Range[15,100]%Vn

Upper Frequency 50.15 50.15 ✓  
Range[50,65]Hz

Lower Frequency 47.50 47.50 ✓  
Range[45,60]Hz

Observation Time 60 60 ✓  
Range[30,30000]s

Soft Ramp Up Gradient

Soft Ramp Up Gradient 16.7 16.7 ✓  
Range[0,6000]%Pn/min

Reconnection:

Upper Voltage 110.4 110.4 ✓  
Range[80,140]%Vn

Lower Voltage 85.2 85.2 ✓  
Range[15,100]%Vn

Upper Frequency 50.15 50.15 ✓  
Range[50,65]Hz

Lower Frequency 47.50 47.50 ✓  
Range[45,60]Hz

Observation Time 60 60 ✓  
Range[30,30000]s

Reconnection Gradient

Reconnection Gradient 16.7 16.7 ✓  
Range[0,6000]%Pn/min

SLG00CON0146

Grid Code (Safety Code) Save

- Europe **Australia** ▾
- Oceania Australia A ○
- America Australia A\_1 ○
- Asia Australia B ○
- Africa **Australia C** ✓
- Others Australia D ○
- New Zealand >
- Others >

Connection Parameters

Ramp Up:

Upper Voltage 110.4 110.4 ✓  
Range[80,140]%Vn

Lower Voltage 85.2 85.2 ✓  
Range[15,100]%Vn

Upper Frequency 50.50 50.50 ✓  
Range[50,65]Hz

Lower Frequency 47.50 47.50 ✓  
Range[45,60]Hz

Observation Time 60 60 ✓  
Range[30,30000]s

Soft Ramp Up Gradient

Soft Ramp Up Gradient 16.7 16.7 ✓  
Range[0,6000]%Pn/min

Reconnection:

Upper Voltage 110.4 110.4 ✓  
Range[80,140]%Vn

Lower Voltage 85.2 85.2 ✓  
Range[15,100]%Vn

Upper Frequency 50.50 50.50 ✓  
Range[50,65]Hz

Lower Frequency 47.50 47.50 ✓  
Range[45,60]Hz

Observation Time 60 60 ✓  
Range[30,30000]s

Reconnection Gradient

Reconnection Gradient 16.7 16.7 ✓  
Range[0,6000]%Pn/min

SLG00CON0145

## Contact Details

GoodWe Technologies Co., Ltd.  
No. 90 Zijin Rd., New District, Suzhou, China  
400-998-1212  
[www.goodwe.com](http://www.goodwe.com)  
[service@goodwe.com](mailto:service@goodwe.com)