



K A C O 
new energy.

KACO blueplanet 3.0 NX1 M2
KACO blueplanet 3.7 NX1 M2
KACO blueplanet 4.0 NX1 M2
KACO blueplanet 5.0 NX1 M2

Manual

- **English translation of German original**

 **Authorised electrician**
Important safety instructions

Legal provisions

The information contained in this document is the property of KACO new energy GmbH. Publication, in whole or in part, requires the written permission of KACO new energy GmbH.

KACO warranty

The latest version of our warranty conditions is available for download at <http://www.kaco-newenergy.com> in the download folder.

Definitions on product designations

In this Manual the product „Photovoltaic feed-in inverter “designated as a device for reading reasons.

Trademarks

All brand and product names used in this document are trademarks or registered trademarks, A lack of identification does not mean that a product or designation/logo is free of trademarks.

Software

This device contains open-source software developed by third parties and in some cases licensed under GPL and/or LGPL.

Further details on the subject and a list of the open-source software used as well as the associated licence texts can be found in the associated "KACO NX Setup" APP in the "Info" menu under "License Wifi-Stick" and "Licence Mobile-APP".

Photovoltaic feed-in inverter

Table of contents

1	General information.....	1	7.2	Surveying the connection area	14
1.1	About this document.....	1	7.3	Making the electrical connection.....	14
1.2	More information	1	7.4	Connecting the device to the power grid.....	15
1.3	Layout of Instructions	1	7.5	Connect PV generator to device.....	16
1.4	Target group.....	2	7.6	Creating equipotential bonding.....	19
1.5	Identification	3	7.7	Connecting the interfaces.....	20
2	Safety	4	7.8	Connecting smart meter for dynamical feed-in	21
2.1	Proper use.....	4	8	Commissioning.....	23
2.2	Protection features.....	5	8.1	Requirements.....	23
3	Description of the device	6	8.2	Preconditions relating to standards.....	23
3.1	Mode of operation	6	9	Configuration and operation.....	24
3.2	System layout.....	6	9.1	Initial start-up.....	24
4	Technical data.....	7	9.2	Signal elements.....	24
4.1	Electrical Data	7	9.3	Monitoring the device	25
4.2	General Data	8	9.4	Performing a firmware update.....	25
4.3	Environmental Data	8	10	Maintenance and troubleshooting	26
4.4	Accessories	8	10.1	Visual inspection.....	26
5	Transportation and Delivery	9	10.2	Cleaning	26
5.1	Scope of delivery	9	10.3	Shutting down for maintenance / troubleshooting	27
5.2	transporting the device	9	10.4	Disconnecting connections.....	27
5.3	Installation tool.....	9	11	Decommissioning and dismantling	28
6	Assembly and preparation	10	11.1	Switching off the device	28
6.1	Choosing the installation location.....	10	11.2	Uninstalling the device	29
6.2	Unpacking the device	11	11.3	Disassembling the device	29
6.3	Fastening the wall bracket.....	11	11.4	Packaging the device	29
6.4	Installing the device	12	11.5	Storing the device	29
7	Installation.....	14	12	Disposal.....	30
7.1	General information	14	13	Service and warranty	30

1 General information

1.1 About this document



WARNING

Improper handling of the device can be hazardous!

› You must read and understand the manual in order to install and use the device safely!

Other applicable documents

During installation, observe all assembly and installation instructions for components and other parts of the system. These instructions also apply to the equipment, related components and other parts of the system.

Some of the documents which are required to register your system and have it approved are included with the manual.

Storing the documents

This manual and other documents must be stored near the system and be available at all times.

- The current version of the operating Instructions can be downloaded from www.kaco-newenergy.com.

English original version

This document has been produced in several languages. The German-language version is the original version. All other language versions are translations of the original version.





1.2 More information

Links to more detailed information can be found at www.kaco-newenergy.com.

Document title	Document type
Technical data sheet	Product flyer
Remote access via iOS / Android App	Application note – Installation and use of the APP
Software package	Automatically update for iOS / Android App
EU Declaration of Conformity Country-specific certificates Certification for specific subassembly	Certificates

1.3 Layout of Instructions

1.3.1 Symbols used

	General hazard		Fire and risk of explosion
	Electrical voltage		Risk of burns
	Earthing - ground conductor		

1.3.2 Safety warnings symbols guide



DANGER

High risk

Failure to observe this warning will lead directly to serious bodily injury or death.



WARNING

Potential risk

Failure to observe this warning may lead to serious bodily injury or death.



CAUTION

Low-risk hazard

Failure to observe this warning will lead to minor or moderate bodily injury.

NOTICE

Risk of damage to property

Failure to observe this warning will lead to property damage.

1.3.3 Additional information symbols



NOTE

Useful information and notes

Information that is important for a specific topic or objective, but that is not safety-relevant.

1.3.4 Symbols for instructions

 Prerequisite for use.

1 Carry out the next step

2 Additional action sequence

⇒ Interim result of the action

» End result

1.4 Target group

All activities described in the document may only be carried out by specially trained personnel with the following qualifications:

- Knowledge about how an inverter functions and operates
- Training in the handling of hazards and risks during the installation and operation of electrical devices and systems.
- Education concerning the installation and start-up of electrical devices and systems.
- Knowledge of applicable standards and directives.
- Knowledge and adherence to this document with all safety notices.

1.5 Identification

You will find the name plate with the following data for service and other requirements specific to installation on the right side panel of the product:

- Product name
- Part no.
- Serial number
- Date of manufacture
- Technical data
- Disposal information
- Certification marking, CE marking.





 KACO new energy Werner-von-Siemens-Allee 1 74172 Neckarsulm		blueplanet 5.0 NX1 M2 WM OD II90			
		Part number	1002018		
		Serial number	5.0NX12000001	Year	Q1 / 21
					
Input	V _{max} PV / I _{sc} PV(max) / I _{nom} PV	580 V / 2x18 A / 2x 12 A			
	V - MPP at P _{nom} / V - range	220 V - 480 V / 80 V - 550 V			
Output	Nominal voltage	220 V (1/N/PE)			
		230 V (1/N/PE)			
		240 V (1/N/PE)			
	Voltage range continuous operation	180 Vac - 290 Vac			
	Current(maximum continuous)	22.7 A			
	Frequency range	45 Hz - 65 Hz			
Output Power	S _{nom} at 230 V U _{nom}	5000 VA			
	Reactive power	0 - 60% S _{nom}	cos phi	0.8 - 0.8 ind/cap	
Environment	Temperature range	-25°C...+60°C / -13°F...+140°F			
	Protection class / Ingress protection	I / IP65			
No galvanic separation / Ungrounded Arrays Only		Max. Backfeed Current	0		
Grid Support Interactive Inverter		ARC fault circuit protection	none		
Interface protection according to country specific requirements, details see manual					
					
					

Fig. 1: Name plate

2 Safety

Before using the product for the first time, please read through the safety instructions carefully.

DANGER

Lethal voltages are still present in the connections and cables of the device even after the device has been switched off and disconnected!

Coming into contact with the lines and/or terminals/busbars in the device can cause serious injury or death.



- › Do not open the device.
- › The device must be mounted in a fixed position before being connected electrically.
- › Comply with all safety regulations and current technical connection specifications of the responsible power supply company.
- › The device is only permitted to be mounted, installed and commissioned by a qualified electricians.
- › Switch off the grid voltage by turning off the external circuit breakers.
- › Check that all AC and DC cables are completely free of current using a clip-on ammeter.
- › Do not touch the cables and/or terminals/busbars when switching the device on and off.
- › Keep the device closed when in operation.

The electrician is responsible for observing all existing standards and regulations. The following applies:

- Keep unauthorised persons away from the device and/or system
- In particular, making sure that the locally applicable version of the standard ¹ "Requirements for special installations or locations – solar photovoltaic (PV) power supply systems" is observed
- Ensure operational safety by providing proper grounding, conductor dimensioning and appropriate protection against short circuiting
- Observe all safety instructions on the product and in these operating instructions
- Switch off all voltage sources and secure them against being inadvertently switched back on before performing visual inspections and maintenance
- When taking measurements on the live device:
 - Do not touch the electrical connections
 - Remove all jewellery from wrists and fingers
 - Ensure that the testing equipment is in safe operating condition
- Modifications to the surroundings of the device must comply with the applicable national and local standards

2.1 Proper use

The device is a transformerless PV inverter which converts the direct current of the PV generator into grid-compatible single-phase alternating current and then feeds the single-phase alternating current into the public power grid.

The device is built using state-of-the-art technology and in accordance with the recognized safety rules. Nevertheless, improper use may cause lethal hazards for the operator or third parties, or may result in damage to the product and other property.

The device is intended for indoor and outdoor applications and may only be used in countries for which it has been approved or for which it has been released by KACO new energy and the grid operator.

Operate the device only with a permanent connection to the public power grid. The country and grid type selection must be commensurate with the respective location and grid type.

The requirements of the grid operator must be met for grid connection to take place. The permission of the relevant authorities may also be required in order to secure authorisation to connection to the grid.

The inverter must only be operated with PV arrays (PV modules and cabling) of protection class II, in accordance with IEC 61730, application class A.

The enclosed documentation is an integral part of the product. The documentation must be read, observed and stored in a place which is freely accessible at all times.

The name plate must be permanently attached to the product.

Any other or additional use of the device shall be regarded as improper.

This includes:

- Use of a distribution system that is not described (grid type)
- Use of sources other than PV-strings
- Mobile use
- Use in rooms where there is a risk of explosion
- Use in direct sunlight, rain or a storm or other harsh environmental conditions
- Outdoor use in environmental conditions that exceed the limits stated in the technical specifications >Environmental data
- Operation outside the specification intended by the manufacturer
- Overvoltage on the DC connection of over 580 V
- Modifying the device
- Standalone mode

2.2 Protection features

The following monitoring and protection functions are built-in:

- Device temperature monitoring system
- EMC filter to protect the inverter from high-frequency grid interference
- Anti-islanding detection according to the current standards.
- Isolation detection / residual current monitoring and disconnection function to detect isolation faults

3 Description of the device

3.1 Mode of operation

The device converts the DC voltage generated by the PV-modules into AC voltage and feeds this into the power grid. The starting procedure begins when there is sufficient sunlight and a specific minimum voltage is present in the device. The feed-in process begins once the PV generator has passed the insulation test and the grid parameters are within the requirements imposed by the grid operator for a specific monitoring time. If, as it gets dark, the voltage drops below the minimum voltage value, feed-in mode ends and the device switches off.

3.2 System layout

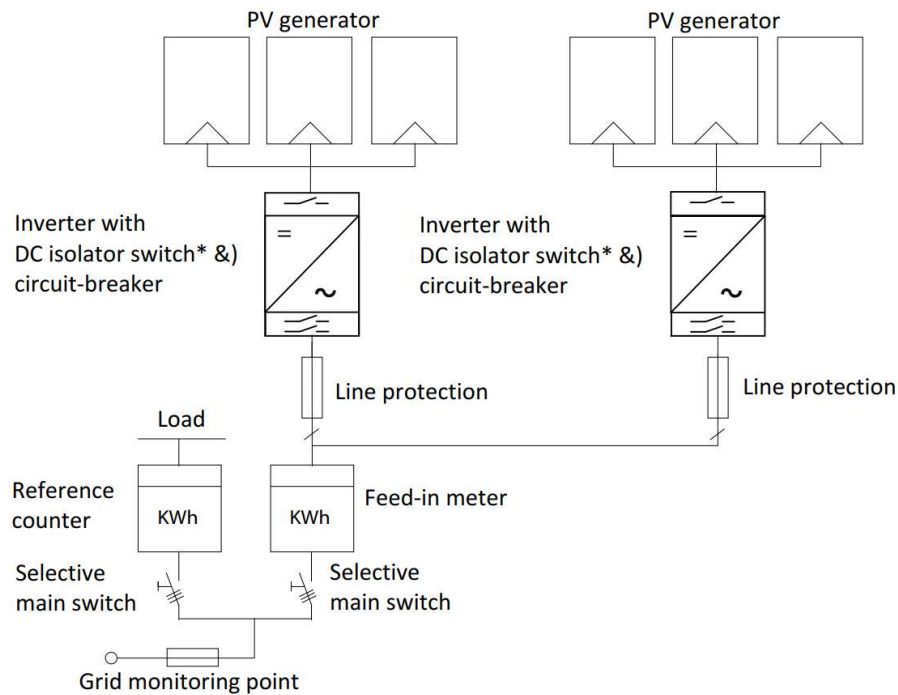

Fig. 1: Circuit diagram of a system with two inverters

Key	Definition / information on the connection
PV generator	The PV generator converts the radiant energy of sunlight into electrical energy.
Inverter with circuit-breaker	The PV generator is connected to the device's DC connection.
Line protection	The circuit breaker is an overcurrent protection device.
Feed-in meter	The feed-in meter is to be specified and installed by the power supply company. Some power supply companies also allow the installation of your own calibrated meters.
Selective main switch	The selective main switch is to be specified by the power supply company.
Reference counter	The reference counter is to be specified and installed by the power supply company. This measures the amount of energy drawn.
DC integrated isolator switch	Use the DC integrated isolator switch to disconnect the device from the PV generator.

4 Technical data

4.1 Electrical Data

KACO blueplanet	3.0 NX1 M2	3.7 NX1 M2	4.0 NX1 M2	5.0 NX1 M2
DC Input levels	Input levels (DC)			
Recommended generator power range	3.0 kW	3.68 kW	4.0 kW	5.0 kW
MPP range@Pnom	140-480 V	165-480 V	180-480 V	220-480 V
Working range	80-550 V			
Rated voltage	360 V	360 V	360 V	360 V
Starting voltage	80 V (SPS turn on voltage, feed in voltage is 100V)			
Open circuit voltage	580 V			
Max. input current ²	2*12 A			
Number of strings	2			
Number of MPP controls	2			
Max. short-circuit current (I _{sc} max.)	2*18 A			
Input source feedback current	0 A			
Polarity safeguard	yes			
String fuse	no			
DC overvoltage protection	no			
KACO blueplanet	3.0 NX1 M2	3.7 NX1 M2	4.0 NX1 M2	5.0 NX1 M2
AC Output levels	Output levels (AC)			
Nominal power	3 kVA	3.68 kVA	4 kVA	5 kVA
Rated voltage	220 V / 230 V / 240 V			
Voltage range: continuous operation	180V - 295V			
Rated current	13 A	16 A	17.4 A	21.7 A
Max. continuous current	15 A	16 A	20 A	22.7 A
Contribution to peak short-circuit current ip	48 A			
Initial short-circuit alternating current (I _k " first single period effective value)	24.5 A			
Short circuit current continuous [ms] (max output fault current)	0 A			
Inrush current	<20% of nominal AC current for a maximum of 10ms			
Rated frequency	50/60 Hz			
Frequency range	45 – 65 Hz			
Reactive power	0 - 60% S _{nom}			
cos phi	0.8 inductive.... 0.8 capacitive			
Number of feed-in phases	1			
Distortion factor (THD)	<3%			
Max. voltage range (up to 100 s)	295V			
AC overvoltage protection	no			

² The "Max. input current" is the maximal theoretical value during operation at full power and minimal MPP voltage. The inverter will clip to the maximum AC power output.

The "Max. short-circuit current (I_{SCmax.})" defines together with open circuit voltage (U_{OCmax.}) the characteristic of the connected PV generator. This is the relevant value for string sizing and is the absolute maximal limit for inverter protection. The connected PV-Generator must be designed, that the max short circuit current is below or equal to I_{SCmax.} of the inverter under all foreseeable conditions. In no condition the design may result in a greater short circuit current than I_{SCmax.} of the inverter.

4.2 General Data

KACO blueplanet	3.0 NX1 M2	3.7 NX1 M2	4.0 NX1 M2	5.0 NX1 M2
Max. efficiency	97,5%			
European efficiency	96,02%	96,33%	96,47%	96,70%
Self consumption: Standby	5 W			
Feed-in from	60 W			
Transformer unit	no			
Protection class / over voltage category	I / III			
Grid monitoring	Country-specific			
Distribution system	TN-C-System, TN-C-S-System, TN-S-System, TT-System			
Display	LEDs			
Controls	no			
Menu languages	DE, EN			
Interfaces	Communication device / RS485 (e.g. Smart Meter) (Optional)			
Communication	WLAN			
Radio technology	WLAN 802.11 b / g / n			
Radio spectrum	2412MHz - 2472MHz			
Antenna Gain	2dBi			
Potential-free relay	no			
DC isolator switch	yes			
AC isolator switch	no			
Cooling	natural			
Number of fans	no			
Noise emission	< 25 dB(A)			
Housing material	Aluminium			
HxWxD	355 mm * 376 mm * 145 mm			
Weight	11 kg			
Certifications	Overview: see homepage / download area			

4.3 Environmental Data

KACO blueplanet	3.0 NX1 M2	3.7 NX1 M2	4.0 NX1 M2	5.0 NX1 M2
Installation height	3000m			
Installation distance from coast	3000m			
Ambient temperature	-25 °C ...+60 °C			
Power derating from	40 °C			
Protection rating (KACO installation location)	IP65			
Humidity range (non-condensing) [%]	100%			

4.4 Accessories

Accessories articles	KACO order no.
NX1 smart meter connection kit	3015112
Eastron SDM230	3015113

5 Transportation and Delivery

Every product leaves our factory in perfect electrical and mechanical condition. Special packaging ensures that the devices are transported safely. The shipping company is responsible for any transport damage that occurs.

5.1 Scope of delivery

Object	Description	Quantity
A	Inverter	1 piece
B	Wall mounting bracket	1 piece
C	Mounting accessory kit: Wall anchors and hexagon bolts (3×) M4×10 mm screw (4×)	1 set
D	DC connector	2 pairs
E	AC Plug connector	1 piece
F	Communication device (WiFi-Stick)	1 piece
G	Documentation	1 set

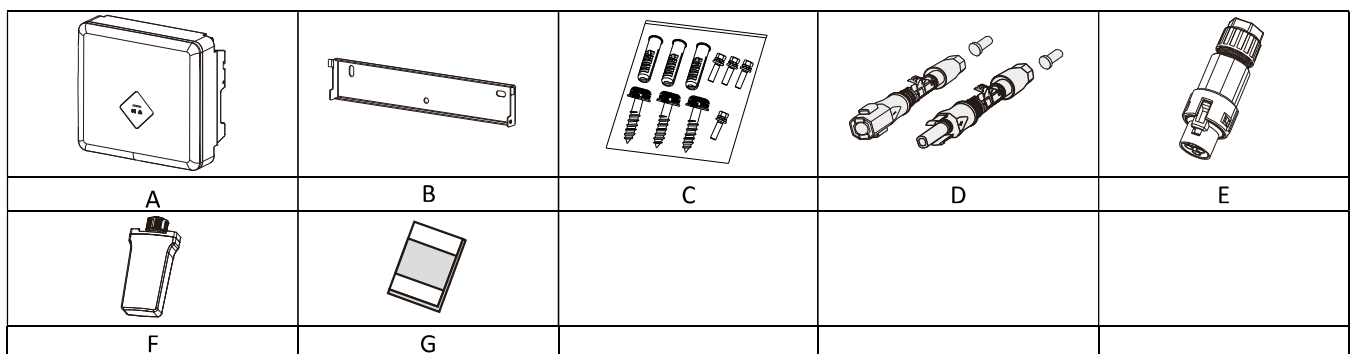

Check the equipment included

- 1 Inspect the device thoroughly.
- 2 Immediately notify the shipping company in case of the following:
 - Damage to the packaging that indicates that the device may have been damaged.
 - Obvious damage to the device.
- 3 Send a damage report to the shipping company immediately.
- 4 The damage report must be received by the shipping company in writing within six days following receipt of the device. We will be glad to help you if necessary.

5.2 transporting the device

CAUTION







Hazard due to impact; risk of breakage to the device!

- › Pack the device securely for transport.
- › Transport the device using the intended carrying handles of the packaging box.
- › Do not expose the device to any shocks.

5.3 Installation tool

The codes given in the table below are used in all usage instructions for assembly/installation/maintenance and disassembly for the tools and tightening torques being used.

Code (s)	Shape of the connector
 W	External hexagon
 T	Torx
 S	Slotted
 P	Phillips

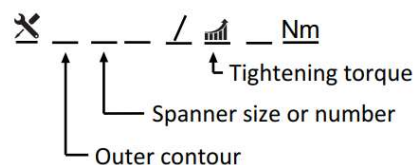

Fig. 2: Form pattern

6 Assembly and preparation

6.1 Choosing the installation location

DANGER



Risk of fatal injury due to fire or explosions!

Fire caused by flammable or explosive materials in the vicinity of the device can lead to serious injuries.

- › Do not mount the inverter in potentially explosive atmospheres or in the vicinity of highly flammable materials

CAUTION



Property damage due to gases that have an abrasive effect on surfaces when they come into contact with ambient humidity caused by weather conditions.

The device housing can be seriously damaged due to gases in combination with air humidity resulting from weather conditions (e.g. ammonia, sulphur).

- › If the device is exposed to gases, the installation must be carried out at observable locations.
- › Perform regular visual inspections.
- › Immediately remove any moisture from the housing.
- › Ensure adequate ventilation at the installation location.
- › Immediately remove dirt, especially on vents.
- › Failure to observe these warnings may lead to device damage which is not covered by the manufacturer warranty.



NOTE

Access by maintenance personnel for service

Any additional costs arising from unfavourable structural or mounting conditions shall be billed to the customer.

Installation space

- As dry as possible, climate-controlled, the waste heat must be dissipated away from the device
- Unobstructed air circulation
- When installing the device in a control cabinet, provide forced ventilation for sufficient heat dissipation
- Close to the ground, accessible from the front and sides without requiring additional resources
- Protected on all sides against direct weather exposure and sunlight (thermal heating) in outdoor areas. Implementation where necessary via constructional measures, e.g. wind breaks

Installation surface

- Must have adequate load-bearing capacity
- Must be accessible for installation and maintenance
- Must be made out of heat-resistant material (up to 90 °C)
- Must be flame resistant
- Minimum clearances to be observed during installation

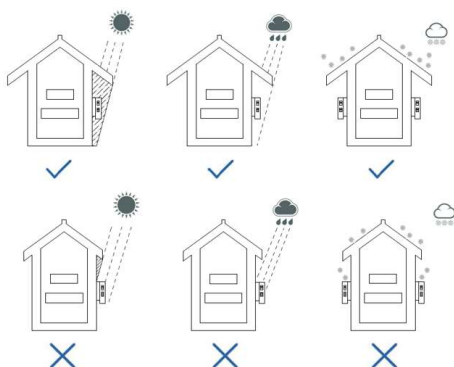

Fig. 3: Device for outdoor installation

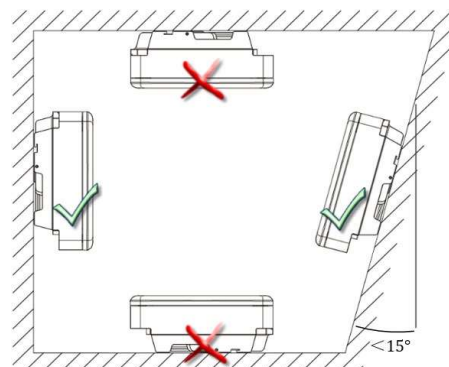

Fig. 4: Permissible installation location

6.2 Unpacking the device



CAUTION

Risk of injury caused by excessive physical strain

Lifting the device, for transport, relocation and assembly, can result in injuries (e.g. back injuries).

› Only lift the device using the grip recesses provided

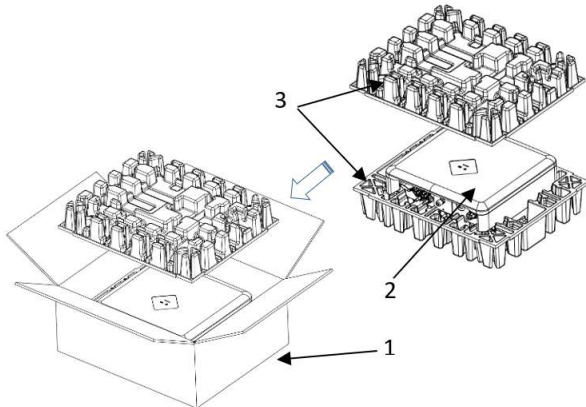

Fig. 5: Unpacking the unit

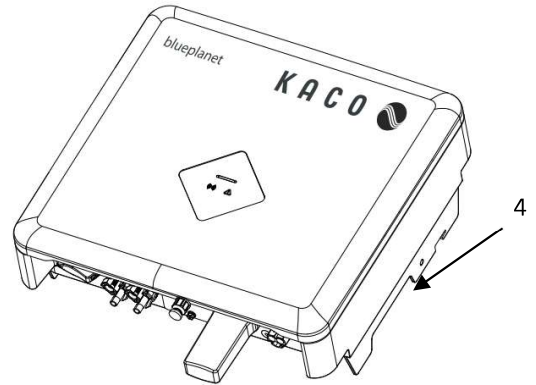

Fig. 6: Lift the unit

Key

1	Carton	3	Protective packaging
2	Device	4	Grip recesses

↻ The device is transported to the installation location.

- 1 Loosen packaging tape from cardboard box.
- 2 Open carton at the front.
- 3 Remove installation material and documentation.
- 4 Pull up top protective packaging to remove.
- 5 Remove device from the packaging.
- 6 Place the protective packaging back into the carton.
- 7 Lift the device at the intended positions.

» Continue installing the mount

6.3 Fastening the wall bracket

CAUTION



Hazard when using unsuitable fixing materials!

If unsuitable fixing materials are used, the device could fall and persons in front of the device may be seriously injured.

- › Use only fixing materials that are suitable for the mounting base. The fastening materials supplied are only suitable for masonry and concrete.
- › Only install the device in an upright position.

NOTE



Power reduction due to heat accumulation!

If the recommended minimum clearances are not observed, the device may go into power regulation mode due to insufficient ventilation and the resulting heat build-up.

- › Observe minimum clearances and provide for sufficient heat dissipation.
- › All objects on the device housing must be removed during operation.
- › Ensure that no foreign bodies prevent heat dissipation following device installation.

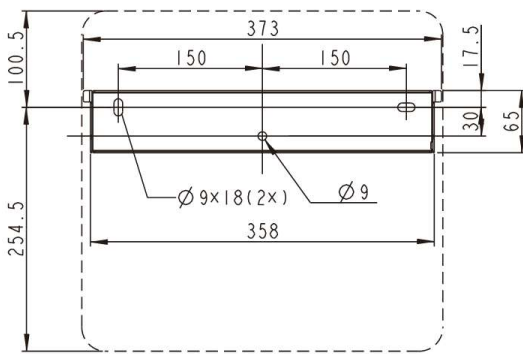

Fig. 7: Drilling holes for wall mounting

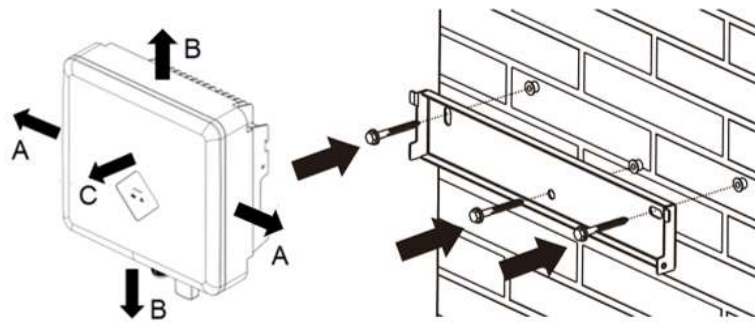

Fig. 8: Mounting wall bracket

Key

1 Drilling three holes [Ø 10mm with depth 70mm]	5 Screw for securing purposes
2 Insert screws and anchors	A Minimum clearance: 300 mm
3 Take out the wall bracket	B Minimum clearance: 500 mm
4 Mounting the wall bracket	C Minimum clearance: 500 mm

☞ Cardboard packaging with mount and mounting kit removed from the packaging and opened.

1 Mark the mounting position on the wall surface according to the position of the mount plate by drawing three marks.

2 Mark the positions of the drill holes and drill three holes.

NOTE: The minimum clearances between two devices, or the device and the ceiling or floor have already been taken into account in the diagram.

3 Fix the mount to the wall using suitable mounting fixtures [~~X~~W-10].

NOTE: Make sure that the mount is oriented correctly.

» Proceed with the installation of the device

6.4 Installing the device

CAUTION



Risk of injury from improper lifting and transport.

If the device is lifted improperly, it can tilt and result in a fall.

- › Always lift the device vertically using the grip recesses provided.
- › Use a climbing aid for the chosen installation height.
- › Wear protective gloves and safety shoes when lifting and lowering the device.

Lifting and installing the device

☞ The mount has been installed.

1 Lift the device using the grip recesses. Observe the device's centre of gravity!

2 Fit the device onto the mounting bracket. Check both sides of the heat sink to ensure that it is securely in place.

3 Insert the screw provided into the lug of the mount and secure the device to prevent it from being lifted off. [~~X~~P /  2 Nm]

NOTE: Alternatively: At this point, the screw described above can be replaced by a special screw as anti-theft protection.

» Device is installed. Proceed with the electrical installation

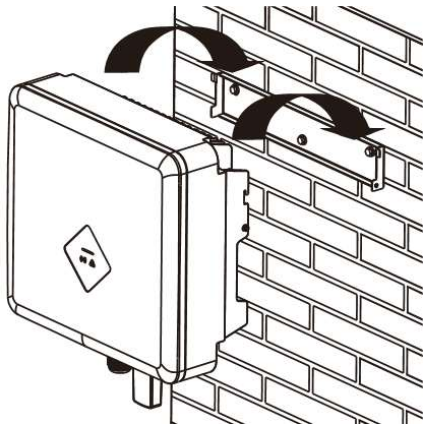

Fig. 9: Mounting the inverter to the wall bracket

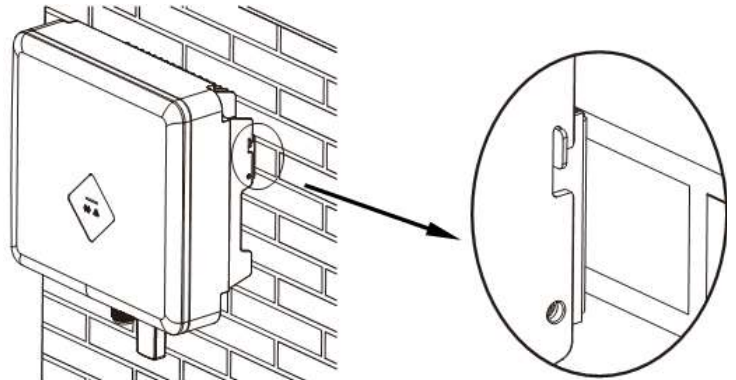

Fig. 10: Check the device is fix

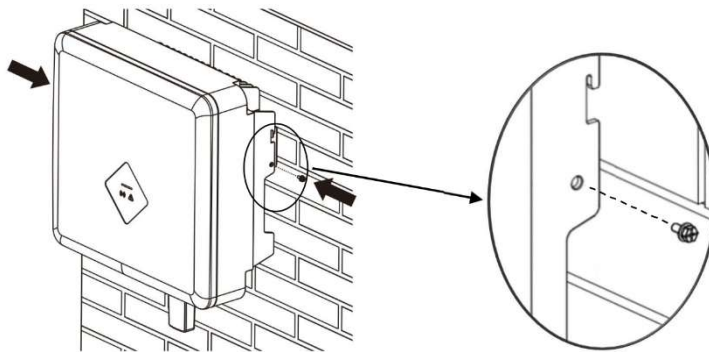

Fig. 11: Fixing the inverter

CAUTION

Property damage as a result of condensation

During pre-assembly of the devices, moisture can penetrate into the interior via the DC plug connectors and the dust-protected threaded connections. The resulting condensate can cause damage to the device during installation and start-up.



- ✓ Keep the device closed during pre-assembly and do not open the connection area until you perform installation.
- › Seal off any plug-in connections and screw fittings using sealing covers.
- › Prior to installation, check the inner area for condensation and if necessary, allow it to dry sufficiently before installation.
- › Immediately remove any moisture from the housing.

7 Installation

7.1 General information

DANGER

Lethal voltages are still present in the connections and cables of the device even after the device has been switched off and disconnected!

Severe injuries or death may occur if the cables and/or terminals/busbars in the device are touched.



- › Do not open the product.
- › The device must be mounted in a fixed position before being connected electrically.
- › Comply with all safety regulations and current technical connection specifications of the responsible power supply company.
- › Switch off the grid voltage by turning off the external circuit breakers.
- › Check that all AC and DC cables are completely free of current using a clip-on ammeter.
- › Do not touch the cables and/or terminals/busbars when switching the device on and off.

7.2 Surveying the connection area

The connection for the AC supply is located on the enclosure in the lower right area. The DC input source is connected to the DC plugs and DC sockets on the base plate.

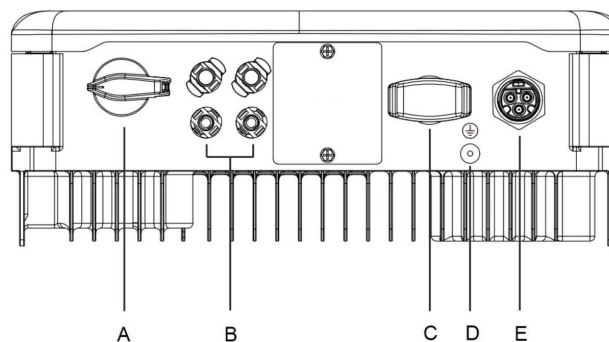

Fig. 12: Surveying the connection area

A	DC integrated isolator switch	D	Housing grounding
B	DC connector for PV generator	E	AC connection socket
C	Communication device connection		

7.3 Making the electrical connection

NOTE



Select conductor cross-section, safety type and safety value in accordance with the following basic conditions:

Country-specific installation standards; power rating of the device; cable length; type of cable installation; local temperature.

7.3.1 Requirement for supply lines and fuse

DC-side	
Max. external diameter	5 – 8 mm
Max. cable cross-section (with wire sleeves)	2.5 - 6 mm ² (DC plug connector)
Recommended cable type	Solar cable
AC-side	
Max. conductor cross-section	4 - 6.0 mm ²
Max. external diameter (with wire sleeves)	10 - 16 mm

Length of insulation to be stripped off	13 mm
Connection type	Vaconn AC connector
Fuse protection for installation provided by customer	Max 25 A at 6 mm ²
Tightening torque	2.0 Nm
Communication	
Recommended RS485 bus cable	LiYCYv (twisted pair) black for laying cable outside and in the ground, 2 x 0.5 mm ² LiYCY (twisted pair) grey for dry and damp indoor spaces, 2 x 0.5 mm ²

7.4 Connecting the device to the power grid

7.4.1 Configuring the AC connection plug

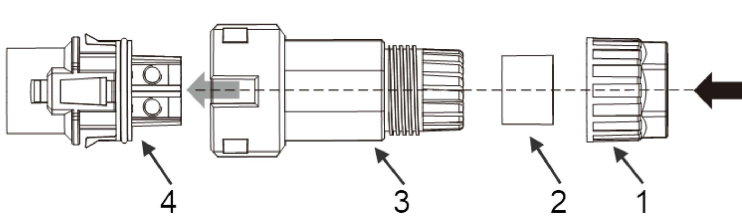

Fig. 13: AC connection plug

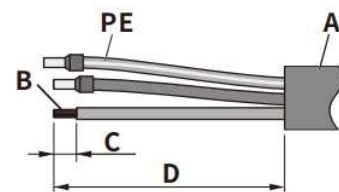

Fig. 14: Connect wires

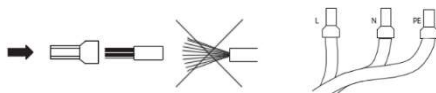

Fig. 15: Crimp ferrule to the contact

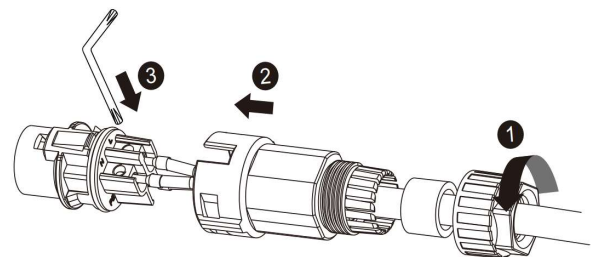

Fig. 16: Tighten the cable screw fitting

Key			
1	Cable fitting	A	External diameter (ϕ 10 to 16 mm)
2	Seal	B	Conductor cross-section (4 to 6 mm ²)
3	Housing	C	Stripping length of the insulated conductors (approx. 13 mm)
4	Contact carrier	D	Stripping length of the outer sheath of AC cable (approx. 53 mm)

🔄 You have completed assembly.

- 1 Slide the cable fitting over the cable.
 - 2 Select seal according to cable diameter used.
 - 3 Slide the housing and seal over the cable.
 - 4 Remove the insulation from the cable. [sl. 53 mm]
 - 5 Shorten the wires N, L by 2 mm than PE conductor.
 - 6 Strip the wires N, L, PE by 13 mm.
 - 7 Flexible wires must be fitted with wire sleeves in accordance with DIN 46228.
 - 8 Insert wires into the contacts in accordance with the markings on the contact carrier.
 - 9 Tighten screws on contact carrier. [\times T_8 / μ 2.0 Nm]
 - 10 Press contact carriers into the housing with an audible "click".
 - 11 Secure the housing and tighten the cable screw fitting. [\times W_29 / μ 3.5 Nm]
- » Make the electrical connections.

7.4.2 Make the grid connection

↻ AC connection plug configured correctly.

- 1 Insert the AC connection plug into the device connector on the device.
 - ⇒ **NOTE: The AC connection is secure when an audible click is heard.**
 - 2 Lay the cables correctly and in accordance with the following rules:
 - Lay the cables around the device with a minimum clearance of 20 cm
 - Never lay cables over semiconductors (cooling bodies).
 - Excessive bending force may negatively impact the protection rating. Lay the cables with a bending radius of at least 4 times the cable diameter.
- » The device is connected to the power grid

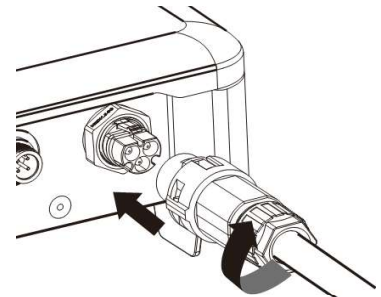

Fig. 17: Engage the AC connector with the device connector



NOTE

An AC-side disconnection unit must be provided during the final installation stage. This disconnecter mechanism must be installed so that it can be accessed at any time without obstruction.



NOTE

If a residual current circuit breaker is necessary due to the installation specification, a type A residual current circuit breaker must be used.

For questions regarding the appropriate type, please contact the installer or our KACO new energy customer service.



NOTE

When the line resistance is high, i.e. long cables on the grid side, the voltage at the grid terminals of the device will increase in feed-in mode. If the voltage exceeds the country-specific grid overvoltage limit value, the device switches off.

Ensure that the cable cross-sections are sufficiently large or that the cable lengths are sufficiently short.

7.5 Connect PV generator to device

7.5.1 Configuring the DC plug connector

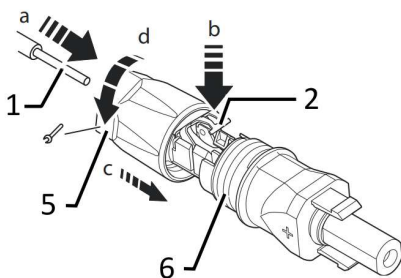

Fig. 18: Insert wires

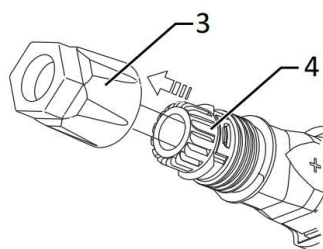

Fig. 19: Slide insert into sleeve

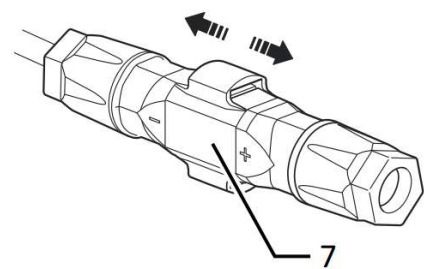

Fig. 20: Check fastening

Key

1	Wire for DC connection	5	Cable fitting
2	Spring	6	Contact plug
3	Insert	7	Coupling
4	Sleeve		

↻ Connection area opened

↻ **NOTE: Before proceeding with the isolation ensure that you do not cut any individual wires.**

- 1 Insert isolated wires with twisted ends carefully up to the connection.

NOTE: Wire ends must be visible in the spring.

- 2 Close the spring so that the spring latches.
 - 3 Slide insert into sleeve.
 - 4 Secure and tighten the cover on the cable fitting [$\times W_{15}$ / ≈ 1.8 Nm].
 - 5 Join insert with contact plug.
 - 6 Check latch by lightly pulling on the coupling.
- » Make the electrical connections

NOTE



- The permissible bending radius of at least 4x the cable diameter should be observed during installation. Excessive bending force may negatively impact the protection rating.**
- › All mechanical loads must be absorbed in front of the plug connection.
 - › Rigid adaptations are not permitted on DC plug connectors

7.5.2 Checking the PV generator for a ground fault

DANGER



Risk of fatal injury due to electric shock!

Severe injury or death will result if the live connections are touched. When there is sunlight present on the PV generator, there is DC voltage on the open ends of the DC cables.

- › Only touch the PV generator cables on the insulation. Do not touch the exposed ends of the cables.
- › Avoid short circuits.
- › Do not connect any strings with a ground fault to the device.

NOTE



The threshold value from which the insulation monitor reports an error can be set in the “Parameters” menu.

Ensure that there is no ground fault

- 1 Measure the DC voltage between the protective earth (PE) and the positive cable of the PV generator.
- 2 Measure the DC voltage between the protective earth (PE) and the negative cable of the PV generator.
 - ⇒ If stable voltages can be measured, there is a ground fault in the DC generator or its wiring. The ratio between the measured voltages gives an indication as to the location of this fault.
- 3 Rectify any faults before taking further measurements.
- 4 Measure the electrical resistance between the protective earth (PE) and the positive cable of the PV generator.
- 5 Measure the electrical resistance between the protective earth (PE) and the negative cable of the PV generator.
 - ⇒ In addition, ensure that the PV generator has a total insulation resistance of more than 2.0 MOhm, since the device will not feed in if the insulation resistance is too low.
- 6 Rectify any faults before connecting the DC generator.

7.5.3 Recommended standard connection

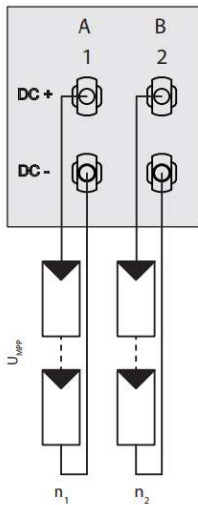

Possible wiring

Two PV generators for each MPP tracker
 The MPP voltages of the two DC strings can be different. They are supplied by separate, independently operating MPP trackers (MPP trackers A and B)

Number of modules per string:

- P_{max} : per string $< 0.6 * \text{max. recommended PV generator power}$
- MPP tracker A+B together $< \text{max. recommended PV generator power}$
- I_{max} : Depending on PV generator
- The input current per MPP tracker must not be exceeded 12 A

Fig. 21: Recommended standard connection

7.5.4 Designing the PV generator

CAUTION



Damage to components due to faulty configuration!

In the expected temperature range of the PV generator, the values for the no-load-voltage and the short circuit current must never exceed the values for U_{dcmax} and I_{scmax} in accordance with the technical data.

- › Observe limit values in accordance with the technical data.

NOTE



Type and configuration of the PV modules

Connected PV modules must be dimensioned for the DC system voltage in accordance with IEC 61730 Class A, but at least for the value of the AC grid voltage.

NOTE



Sizing of the PV generator

The device is designed with a reserve of DC short-circuit current withstand capability. This allows oversizing of the connected PV generator. The absolute limit for the PV generator is the value of the maximum short circuit current (I_{scmax}) and maximum open circuit voltage (U_{ocmax}).

7.5.5 Connecting the PV generator

DANGER



Risk of fatal injury due to electric shock!

Coming into contact with live connections can cause serious injury or death. When there is sunlight present on the PV generator, there is DC voltage on the open ends of the DC cables.

- › Only touch the PV generator cables on the insulation. Do not touch the exposed ends of the cables.
- › Avoid short circuits.
- › Do not connect any strings with a ground fault to the device.

CAUTION



Damage to the PV generator in case of faulty configuration of the DC connector

A faulty configuration of the DC connector (polarity +/-) causes equipment damage in the DC connection if it is connected permanently.

- › Please check polarity (+/-) of the DC connector before connecting the DC generator.
- › Before using the solar modules, check the vendor’s calculated voltage values against those actually measured. The DC voltage of the PV system must not exceed the maximum no-load voltage at any time.

Connecting the PV generator

⌚ DC plug connector be configured and PV generator checked to ensure there is no ground fault.

1 Remove protective caps from the required DC connection plugs on the underside of the device.

2 Connect the DC plug connectors to the DC positive and DC negative connectors in pairs.

» The device is connected to the PV generator.

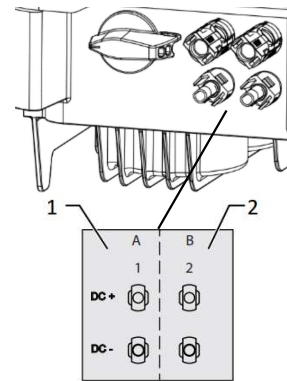

Fig. 22: Connection for DC positive and DC negative

- 1 DC-connection to MPP tracker A
- 2 DC-connection to MPP tracker B

7.6 Creating equipotential bonding



NOTE

Depending on the local installation specifications, it may be necessary to earth the device with a second ground connection. To this end, the threaded bolt on the underside of the device can be used

⌚ The device has been installed on the mount.

1 Insert the grounding conductor into the suitable terminal lug and crimp the contact.

2 Insert Align the terminal lug with the grounding conductor on the screw.

3 Tighten it firmly into the housing [~~X~~ P_2/  1.6Nm].

» The housing is included in the equipotential bonding

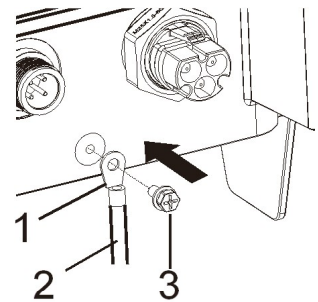

Fig. 23: connect the grounding

Key

- | | | | |
|---|--------------------------------|---|----------|
| 1 | M4 terminal lug | 3 | M4 screw |
| 2 | Grounding protective conductor | | |

7.7 Connecting the interfaces

7.7.1 Communication device connection



NOTE

Damage to the inverter due to electrostatic discharge

Internal components of the inverter can be irreparably damaged by electrostatic discharge.

- › Ground yourself before touching any component.



NOTE

Damage to the communication device due to turn the stick body

When the communication device fastens to the inverter, the nut on the stick should be turned. The communication device be damaged if you turn the stick body.

- › Do not turn the communication device itself to fastening to the inverter.

↻ The device has been installed on the mount.

1 Remove the cap on the COM connector.

2 Insert the communication device into the existing connection and screw it tightly into the connection using the nut on the module.

NOTE: Do not turn the communication device -Module itself to fastening to the inverter.

3 Ensure the communication device is securely connected and the label on the module can be seen.

- » The communication device is connected to the device.

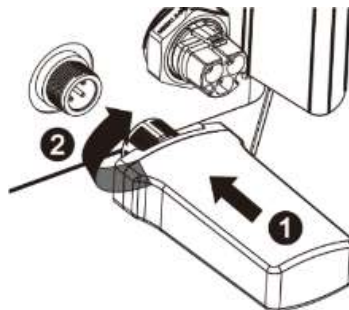

Fig. 24: Connect the communication device

7.8 Connecting smart meter for dynamical feed-in

If you want to implement the function dynamically, you need to install the Smart Meter. The communication device is only compatible with the **Eastron Smart-Meter (SDM230 – Article No. 2015113)** available via our customer service.



NOTE

The Smart-Meter must support the MODBUS protocol and communicates with baud rate 9600, parity “None”, Stop-Bits “1”

Ensure that individual wires at the terminal contact of the Smart-Meter are attached with the correct torque and cannot work loose. Attach protective cover if fitted.



NOTE

Damage to the inverter from electrostatic discharge

Components inside the device can be damaged beyond repair by electrostatic discharge.

› Ground yourself before touching a component.



NOTE

A network cable according to chapter 7.3.1 at Page 14 is required for connection to the RJ45 socket. A network cable with good resistance to UV radiation is also required for use outdoors.

The RS485 connection can support communication with a maximum installation length (across all inverters) of 1000 m. The individual and control connected must be measured in accordance with EMC requirements EN 62920 if the length of the cable attached at the signal and control connection is more than 30 m according to the standard.

⌚ The device and the Smart-Meter have been firmly installed on a mounting bracket.

1. Fit suitable wire sleeves in accordance with DIN 46228-4 to the wires of the required cable and crimp. [wire cross-section 0.6mm²]

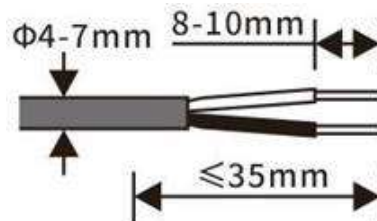

Fig. 25: Configuring the cable

2. Remove the cover plate from the bottom of the housing. (See Fig. 26)
3. Release the forcing nut (Pos. 1) of the cable fitting at the terminal (See Fig. 27).
4. Remove closing plug (Pos. 2) for required communication line, route the line through the forcing nut, the sealing sleeve and terminal, and guide the communication line with three turns through the magnetic ring (Pos. 3).
5. Connect wires of the cable to terminal (Pos 4) as assigned (A/B). [Screwdriver type: PH2, tightening torque: 1.6Nm]
6. Ensure that the cable is firmly attached.

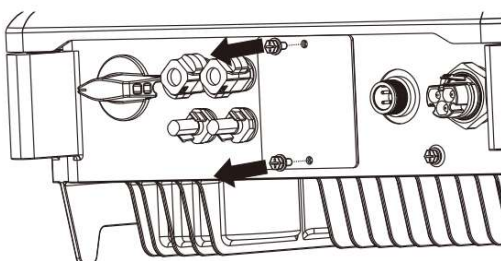

Fig. 26: Removing protective cover

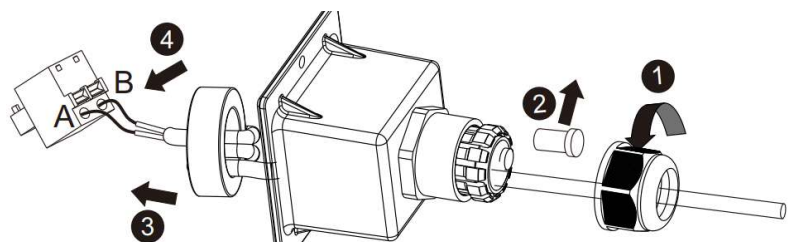

Fig. 27: Routing line through terminal

7. Insert configured terminal into the socket provided. Mount terminal on device using screws of protective cover
Screwdriver type: PH2, tightening torque: 1.6Nm] and tighten forcing nut [tightening torque 3.0-3.5 Nm].

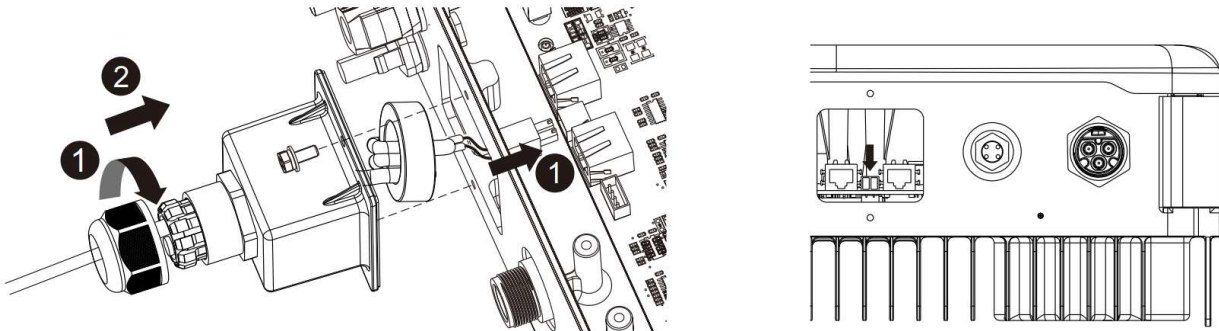

Fig. 28: Inserting terminal into the socket

8. Fit wire sleeve to the other end of the cable and connect to the contacts of the Smart-Meter.
Screwdriver type: PH0, tightening torque: 0.7Nm See Fig. 29.

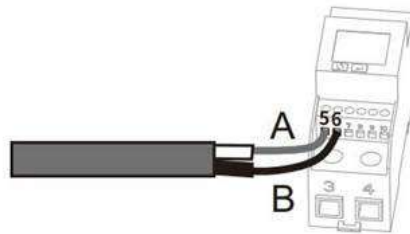

Fig. 29: Connecting to the Smart-Meter



NOTE

Accessories package: NX1 smart meter connection kit (Art. 3015112)

The accessories kit (terminal with seal, clamp, magnetic ring) is available via our customer service

<https://kaco-newenergy.com/de/service/kundendienst/>

8 Commissioning

8.1 Requirements

 **DANGER**



Lethal voltages are still present in the connections and cables of the device even after the device has been switched off and disconnected!

Severe injuries or death may occur if the cables and/or terminals/busbars in the device are touched.

- › The device is only permitted to be commissioned by a qualified professional.
- › Unauthorised persons must be kept away from the device.

↻ The device has been mounted and electrically installed.

↻ The PV generator supplies a voltage above the configured start voltage.

1 Connect the grid voltage using the external circuit breakers.

2 Connect the PV generator using the DC isolator switch (0 > 1)

» The device begins operation.

» During initial start-up: Follow the instructions of the New Connection Wizard.

8.2 Preconditions relating to standards

Attachment of safety label in accordance with UTE C15-712-1

The code of practice UTE C15-712-1 requires that, upon connection to the French low-voltage distribution network, a safety sticker showing a warning to isolate both power sources when working on the device must be attached to each device

 Attach the provided safety sticker to the outside of the device housing where it is clearly visible.



9 Configuration and operation

9.1 Initial start-up

When started for the first time, set the country data set appropriate for your country. Please visit website www.kaco-newenergy.com and download the document "Application note – Installation and use of the APP" detailed information.

9.2 Signal elements

There are status LEDs on the communication device and on the inverter housing that indicate the operating status. The LEDs can assume the following states:

	LED lights up		LED flashes		LED flash quickly
---	---------------	---	-------------	---	-------------------

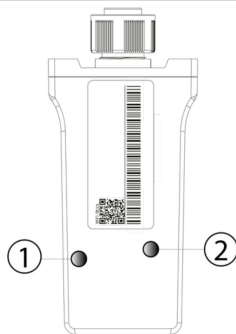

Fig. 30: LEDs on the communication device

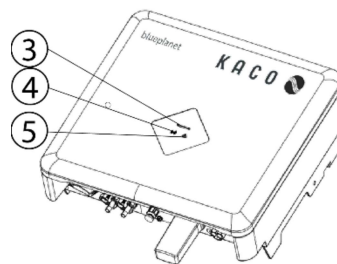













Fig. 31: LEDs at the device

Pos.	LEDs on the Communication device	LED	Description
1	Network Communication		Note: For the AP network configuration, you must be connected to the local WLAN network of the device to re-enter the router information. The password for the local WLAN network is the registration key that you will find on the type plate (see also: "Application note - Installation and use of the APP"). The blue "Network" LED flashes when the communication device is connected to the WLAN network.
			The blue "Network" LED lights up when the inverter is connected to the web portal. If the LED does not light up, check whether the network SSID and password are correct and whether the WLAN signal is strong enough.
2	Device communication		The green "Operation" LED lights up when the communication device establishes communication with the device. If it does not light up, there is a hardware defect. Contact our KACO service.
			The green LED "Operation" flashes if the connection fails due to invalid router information. Use the KACO NX SETUP - APP to perform the network configuration.
			The green "Operation" LED flashes quickly when the communication device is in network configuration mode. this deactivates the unit's data acquisition.
Pos.	Operating status on the unit	LED	Description
3	Standby self-test		The white "Operation" LED flashes when AC and DC voltage is present. The unit performs a self-test. After flashing, the unit is ready to feed in power.
3	Feed-in operation		The white "Operation" LED lights up when the unit is feeding into the mains. In the event of a fault, the LED is off.

3	Feed-in operation with Power reduction		Note: The dynamic power display is additionally realized via the LED. The white "Operation" LED flashes quickly if there is a power reduction of over 45%-90%. If the power drops below 45%, the LED pulses slowly.
4	Communication		The white "Communication" LED flashes during communication with other devices (data logger, smart meter, communication device) and during a firmware update via RS485. The LED does not light up if communication is interrupted or does not exist.
5	Malfunction		The red "Fault" LED lights up due to a fault and the feed-in to the grid is interrupted. The corresponding error code is displayed in the corresponding KACO NX SETUP - APP on your mobile device. If there is no fault, the LED goes out.
1-5	Offline		No LED is lit. There is no AC/DC supply to the unit.

↻ Communication device is plugged into the unit and firmly screwed in. Unit is connected on the AC and DC sides.

Note: Observe the status of the LED during initialization, operation and fault messages. This can give you precise information about the current operating status of the device.

1 Check on the communication device that the blue LED lights up during the initialization process. If not, check the attachment again. Otherwise, replace communication devices with others if necessary.

2 Check on the unit that the white LED lights up in feed mode. If not, there is a fault in the unit.

Note: In case of malfunctions, follow the instructions in the "Application note - Installation and use of the APP" in the chapter Troubleshooting.

» Continue with setting up the unit monitoring.

9.3 Monitoring the device

User can monitor the device through the external communication device. The operating data of the device can transfer to the Cloud. And the user can view all the data on your mobile device with the KACO NX Setup - APP.

Every device provides a communication device. If the same devices are installed at the same location together, the device can connect through the RS 485 cable and share one communication device. Please note that each communication device can only connect up to 5 devices.

The Android or iOS APP can be download on the store. More Information you will find in the document "Application note – Installation and use of the APP" in download folder on our website www.kaco-newenergy.com.

9.4 Performing a firmware update

You can update the software of the device to a new version using the app Android or iOS. Please visit website www.kaco-newenergy.com and download the document "Application note – Installation and use of the APP". Here you will find more information about firmware update.

10 Maintenance and troubleshooting

10.1 Visual inspection

Inspect the product and cables for visible external damage and note the operating status display, where applicable. In the event of damage, notify your installation engineer. Repairs may only be carried out by authorised electricians

DANGER



Dangerous voltage due to two operating voltages!

Removing the plug connections before disconnecting the device from the PV generator may lead to injuries and damage the device.

- › During installation: Electrically disconnect the DC positive and DC negative from the protective earth (PE).
- › Disconnect the device from the PV generator using the integrated DC isolator switch.
- › Remove the plug connector.

DANGER



Dangerous voltage due to two operating voltages

Severe injuries or death may occur if the cables and/or terminals/busbars in the device are touched. The discharge time of the capacitors is up to 5 minutes.

- › Only appropriately qualified electricians authorised by the mains supply network operator are permitted to open and maintain the device.
- › Before opening the device: Disconnect the AC and DC sides and wait at least 5 minutes.

NOTE



There is not any component in the housing of the device which can be repaired by the customer.

Do not attempt to repair faults that are not described here (in the chapter on troubleshooting and fault rectification). Contact our customer service department. Only perform the maintenance work that is described here.

The device should be checked for proper operation by a qualified electrician at regular intervals and if you experience problems, you should always contact the system manufacturer service department.

10.2 Cleaning

10.2.1 Cleaning the housing

DANGER



Danger of death due to penetrating fluid

Serious injuries or death can result if moisture enters the system.

- › Only use completely dry objects to clean the device.
- › The device should only be cleaned from the outside.

CAUTION



Do not use compressed air or high-pressure cleaners!

- › If the device is contaminated, only clean the housing, cooling fins, housing cover with water and a cloth.

1 Use a vacuum cleaner or a soft brush to remove dust from the top of the device on a regular basis.

2 Remove dust from the ventilation inlets if necessary.

10.2.2 Cleaning the heat sink

↻ Device switched off on integrated DC isolator switch and AC breaker.

1 Use the compressed air to clean the heat sink.

» Switch unit on



NOTE

Refer to our service and guarantee conditions on our homepage.

- ✓ The cleaning intervals must be adapted to match the ambient conditions of the installation location.
- › In sandy environments, we recommend cleaning the heat sinks every quarter.

10.3 Shutting down for maintenance / troubleshooting

DANGER



Lethal voltages are still present in the connections and cables of the device even after the device has been switched off and disconnected!

Severe injuries or death may occur if the cables and/or terminals/busbars in the device are touched.

Only appropriately qualified electricians authorised by the mains supply network operator are permitted to open and maintain the device.

- › Comply with all safety regulations and current technical connection specifications of the responsible power supply company.

10.4 Disconnecting connections

10.4.1 AC connection

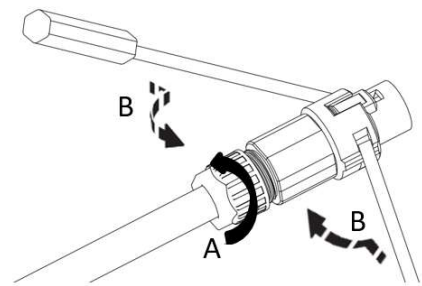
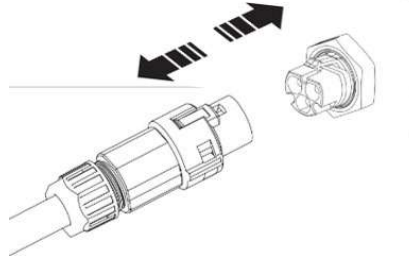
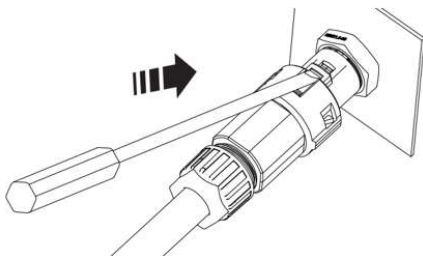

Fig. 32: Detach the AC connection plug

Fig. 33: Disconnect AC connection plug

Fig. 34: Release the cable

↻ Ensure there is no AC/DC voltage present.

- 1 Use a screwdriver (blade size 3 mm) to push in the latch on the coupling.
- 2 Unlock the plug connection and pull out the connector.
- 3 Unscrew the cable fitting.
- 4 Use a screwdriver to unlock the contact carrier on both sides.
- 5 Remove the contact carrier from the housing.
- 6 Unfasten and remove the screws on the contact carrier.

10.4.2 DC connection

DANGER



Destruction of the DC plug connectors !

DC plug connectors can be destroyed by arcing if disconnected while still live. It is absolutely essential that the following shutdown sequence be carried out in the correct order:

- › Check that there is no current in any of the DC cables using a clip-on ammeter.

- ↻ Ensure there is no AC/DC voltage present.
 - ↻ Check that there is no current using a clip-on ammeter.
 - ↻ NOTE: Plug connectors may be unplugged under voltage, but never under load.
- 1 Use a screwdriver (blade width 3 mm) to push out the latch on the coupling.
 - 2 Leave the screwdriver in place.
 - 3 Disconnect the DC connector from the DC socket.

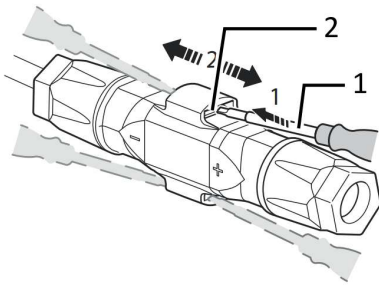

- | | |
|---|-------------|
| 1 | Screwdriver |
| 2 | Latch |

Fig. 35: Unplugging the plug connector

11 Decommissioning and dismantling

11.1 Switching off the device

DANGER

Lethal voltages are still present in the connections and cables of the device even after the device has been switched off and disconnected!

Severe injuries or death may occur if the cables and/or terminals/busbars in the device are touched.



- › The device must be mounted in a fixed position before being connected electrically.
- › Comply with all safety regulations and current technical connection specifications of the responsible power supply company.
- › The device is only permitted to be opened or serviced by a qualified electrician.
- › Switch off the grid voltage by turning off the external circuit breakers.
- › Check that all AC and DC cables are completely free of current using a clip-on ammeter.
- › Do not touch the cables and/or terminals/busbars when switching the device on and off.
- › Keep the device closed when in operation.

DANGER

Destruction of the DC plug connectors!

DC plug connectors can be destroyed by arcing if disconnected while still live. It is absolutely essential that the following shutdown sequence be carried out in the correct order:

- › Check that there is no current in any of the DC cables using a clip-on ammeter.



WARNING

Risk of burns caused by hot housing components

Housing components can become hot during operation.

- › During operation, only touch the housing cover on the device.



11.2 Uninstalling the device



DANGER

Dangerous voltage due to two operating voltages

Coming into contact with the lines and/or terminals/busbars in the device can cause serious injury or death. The discharge time of the capacitors is up to 5 minutes.

- › Only appropriately qualified electricians authorised by the mains supply network operator are permitted to open and maintain the device.
- › Before opening the device: Disconnect the AC and DC sides and wait at least 5 minutes.

 Device disconnected and secured against restart.

- 1 Disconnect AC connection plug from the device. AC connection [See section 10.4.1} Page 26]
 - 2 Detach the DC cables from the DC plug connectors and furnish with protective caps. DC connection [See section 10.4.2} Page 27]
 - 3 Remove the communication device.
- » The device is uninstalled. Proceed with disassembly

11.3 Disassembling the device

 Unit has been switched off and uninstalled.

- 1 Remove the screw that prevents the device from being lifted off the mount.
 - 2 Use the lateral openings and lift the device off the mount.
 - 3 If available, disassemble the accessories: **NX1 smart meter connection kit** in reverse order according to chapter 7.8.
- » Device removed. Proceed with the packaging process.

11.4 Packaging the device

 Device has been uninstalled.

- 1 If possible, always pack the device in the original packaging. If this is no longer available, an alternative is to use equivalent packaging.
- 2 You must be able to close the box completely and it must be able to accommodate the weight and size of the device.

11.5 Storing the device

CAUTION

Property damage as a result of condensation

Faulty storage can form condensate in the device and impair the device functioning (e.g. storage outside the ambient conditions or temporary relocation from a cold to a hot environment).



- ✓ Store in accordance with the technical data > Environmental data.
- › Prior to installation, check the inner area for condensation and if necessary, allow it to dry sufficiently before installation.

 Device packaged.

Store the device at a dry location, in accordance with the ambient temperature range Environmental data.

12 Disposal

CAUTION



Risk to the environment if disposal is not carried out in the correct manner

For the most part, both the device and the corresponding transport packaging are made from recyclable raw materials.

Unit: Do not dispose of faulty devices or accessories together with household waste. Ensure that the old devices and any accessories are disposed of in a proper manner.

Packaging: Ensure that the transport packaging is disposed of properly.

13 Service and warranty

If you need help solving a technical problem with one of our KACO products, please contact our service hotline. Please have the following information ready so that we can help you quickly and efficiently:

- Device name / serial number
- Date of installation / Start-up report
- Fault message shown on the display / Description of the fault / Did you notice anything unusual? / What has already been done to analyse the fault?
- Module type and string circuit
- Consignment identification / Delivery address / Contact person (with telephone number)
- Information about the accessibility of the installation site

You can find the following items and other information at our web site [Kaco-newenergy](http://Kaco-newenergy.com):

- our current warranty conditions,
- a complaint form,
- a form for registering your device. Please register your device without delay. In this manner, you can assist us in providing you with the quickest service possible



3014852-03-230109

The text and figures reflect the current technical state at the time of printing. Subject to technical changes. No liability for printing error