

Sigen Breaker Installation Guide

Version: Draft A
Release date: 2026-01-15



1 Power and Communication Wiring

Caution

Please prepare cables by yourself. The specifications of the Installer-provided cable must comply with the cable regulations and standards of the country or region standards.

Recommended specification:

Outdoor two-core shielded twisted pair
Cross-sectional area of core conductor:
0.5–0.75 mm² (multi-core flexible conductor,
Tubular terminal needed)
0.5–1 mm² (single-strand hard conductor, no
tubular terminal needed)
Outer diameter: 4.5–6.5 mm
Single cable length: ≤ 1000 m^[1]
Baud rate: ≤ 9600 bps

Note [1]: The cable length should be limited for good communication. Too long cable degrades the communication effect.

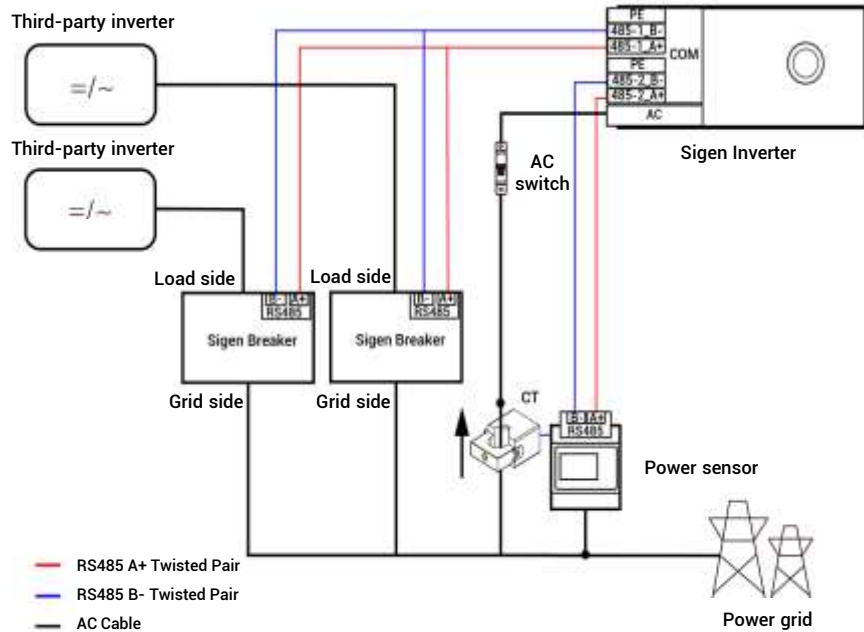

SSA1CM00077

2 Modification of Communication Wiring

Caution

Before connecting to the RS485-1 port of the Sigen Inverter, the actual physical communication wiring of the intelligent circuit breaker's RS485 interface shall be modified in accordance with the instructions below.



Figure 1

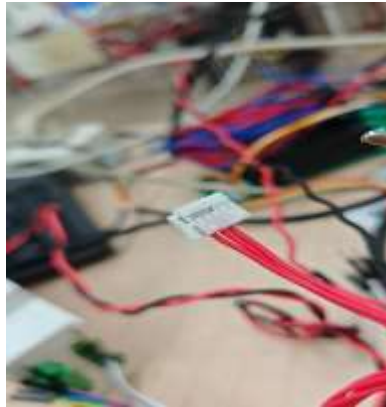

Figure 2

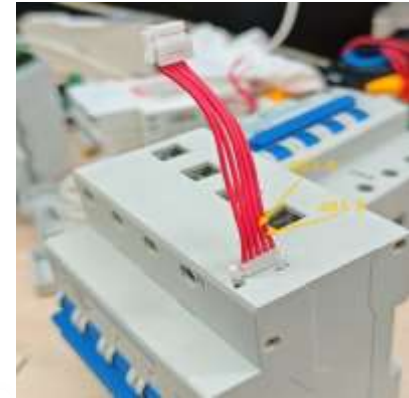

Figure 3

As shown in Figure 3, use tweezers to pull out the other end of the communication wire connected to the white terminal of the intelligent circuit breaker's RS485 interface, or directly cut the wire and strip the insulation of the end separately. Then connect the modified communication wire to the RS485 twisted pair, and finally connect it to the RS485-1 port of the inverter.

3 Signal cable Connection

Tips

- The power sensor needs to be purchased from our company's official channels.
- The appearance and specific wiring of the power sensor can be found in the instruction manual delivered with the case.

3.1 SigenStor COM terminal introduction

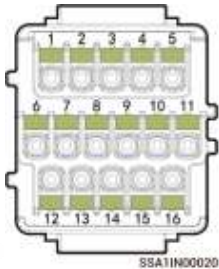

Description	Pin Definition		Pin Number	Sigen Sensor TP-DH(SDM630MODBUS V2)	Sigen Sensor TP-CT120-DH(SDM630 MCT 40mA/120A)	Sigen Sensor TP-CT300-DH(SDM630MCT 40mA/300A)	Sigen Sensor TP-CT600-DH(SDM630MCT V2/600A)
(Reserved) Supports a maximum signal voltage of 12 V and a signal current of 1 A. Connecting to third-party smart power equipment, such as switch controllers and heat pumps.	DO1-COM	Dry contact 1-Common	1	-	-	-	-
	DO1-NO	Dry contact 1-Normal Open	2	-	-	-	-
	DO2-COM	Dry contact 2-Common	3	-	-	-	-
	DO2-NO	Dry contact 2-Normal Open	4	-	-	-	-
For power scheduling, such as DRM and Ripple Control Receiver(RCR).	DI1	Digital input 1	5	-	-	-	-
	DI2	Digital input 2	6	-	-	-	-
	DI3	Digital input 3	7	-	-	-	-
	DI4	Digital input 4	8	-	-	-	-
-	GND	Signal GND	10	-	-	-	-
Used to connect the rapid shutdown, NS protection device, Emergency power off button(EPO).	DI5	Digital input 5	9	-	-	-	-
RS485-2, Used to access the grid side power sensor.	PE	PE signal shielding ground	12	-	-	-	-
	485_B2	RS485 signal 2_B-	13	B-	13	13	13
	485_A2	RS485 signal 2_A+	14	A+	14	14	14
RS485-1, Connecting to third-party RS485 communication devices, e.g., Sigen Breaker, third-party EMS controllers, energy meters, or heat pump equipment, etc.	PE	PE signal shielding ground	11	-	-	-	-
	485_A1	RS485 signal 1_A+	15	-	-	-	-
	485_B1	RS485 signal 1_B-	16	-	-	-	-

3.2 Sigen PV (50–110)M1-HYB Series COM terminal introduction

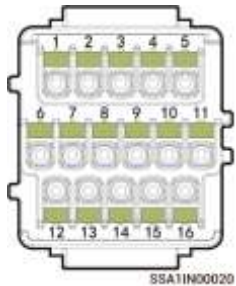

Function description	Pin Definition		Pin Number	Sigen Sensor TP-CT300-DH (SDM630MCT 40mA/300A)	Sigen Sensor TP-CT600-DH (SDM630MCT V2/600A)	Sigen Sensor TPX-CH (DTSU666)
(Reserved) Supports a maximum signal voltage of 12 V and a signal current of 1 A. Connected to third party intelligent electric equipment, such as switch control and heat pump.	DO1-COM	Dry contact 1-Common	1	-	-	-
	DO1-NO	Dry contact 1-Normal Open	2	-	-	-
(Reserved) DO2, Used to connect the generator.	DO2-COM	Dry contact 2-Common	3			
	DO2-NO	Dry contact 2-Normal Open	4			
	DO1-NC	Dry contact 2-Normal Close	11			
For power scheduling, such as DRM and Ripple control Receiver (RCR).	DI1	Digital input 1	5	-	-	-
	DI2	Digital input 2	6	-	-	-
	DI3	Digital input 3	7	-	-	-
	DI4	Digital input 4	8	-	-	-
-	GND	Signal GND	10	-	-	-
Used to connect the rapid shutdown DI interface as the signal cable port for the NS protection device, Emergency power off button(EPO).	DI5	Digital input 5	9	-	-	-
RS485-2, Used to access the grid side power sensor.	RS485B2	RS485 signal 2_B-	13	13	13	25
	RS485A2	RS485 signal 2_A+	14	14	14	24
-	PE	PE signal shielding ground	12	-	-	-
RS485-1, Connecting to third-party RS485 communication devices, e.g., Sigen Breaker, environmental monitors, third-party EMS controllers, etc.	RS485A1	RS485 signal 1_A+	15	-	-	-
	RS485B1	RS485 signal 1_B-	16	-	-	-

3.3 RS485 Signal Cable Connection

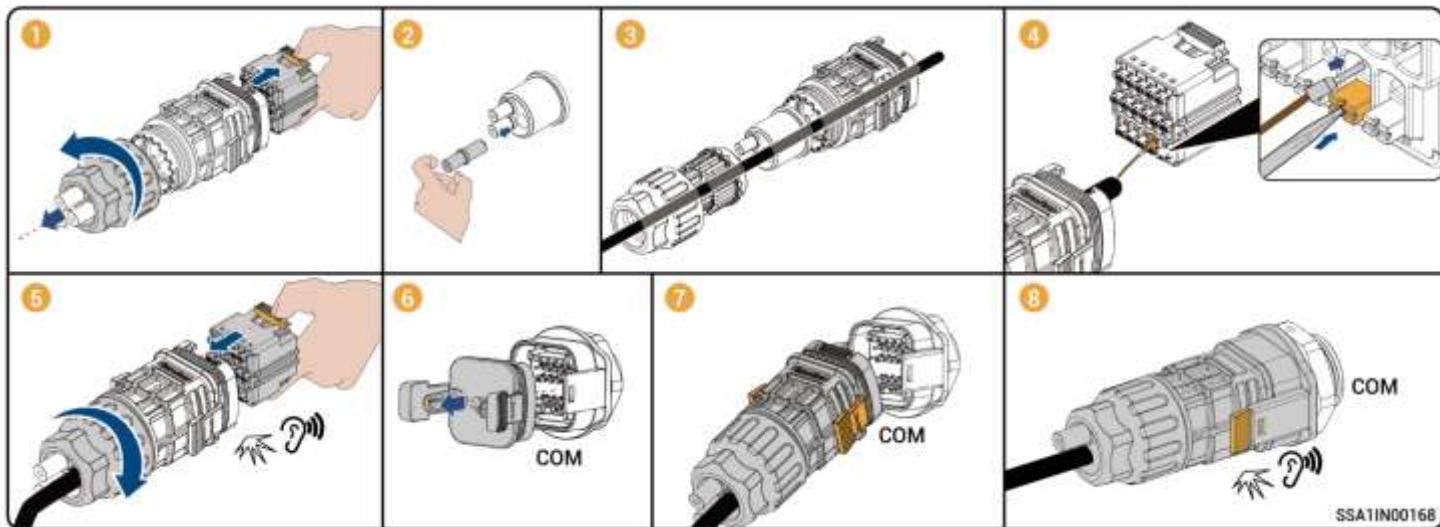
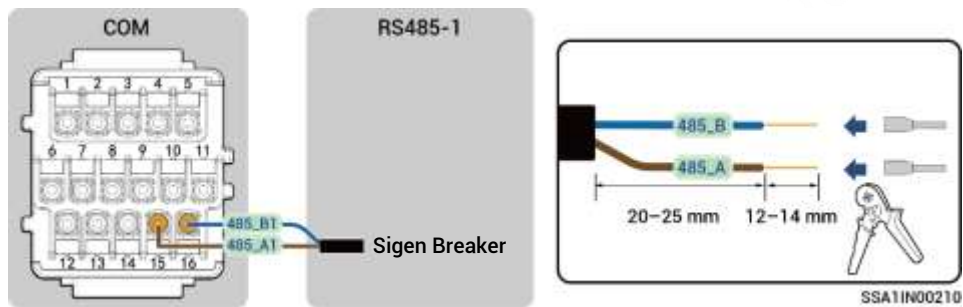

4 Connection via Sigen Breaker

Tips

- Before connecting a third-party inverter, ensure that the Sigen Inverter has been connected to the Sigen Breaker.
- The number of connectable third-party inverters is determined by the maximum connection capacity supported by the Sigen Breaker. For specific limits, refer to the product specification sheet.



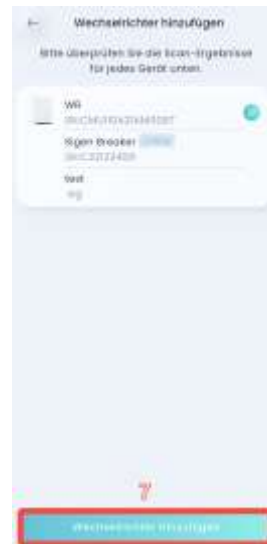

Sigenergy Technology Co., Ltd.



Website	LinkedIn	YouTube
---------	----------	---------

www.sigenergy.com



Copyright © Sigenergy Technology Co., Ltd. 2026. All rights reserved.

Description in this document may contain predictive statements regarding financial and operating results, product portfolio, new technology, configurations and features of product. Several factors could cause difference between actual results and those expressed or implied in the predictive statements. Therefore, description in this document is provided for reference purpose only and constitutes neither an offer nor an acceptance. Sigenergy Technology Co., Ltd. may change the information at any time without notice.