

TRINA SOLAR USER MANUAL

VERTEX SERIES MODULES

APPLICABLE MODULE TYPE

Module type	Module code
Single glass products	DE09
	DE09.05
	DE09.08
	DE09C.05
	DE09C.07
	DE09R
	DE09R.05
	DE09R.08
	DE18M(II)
	DE18M.08(II)
	DE19
	DE19R
	DE20
	DE21
	NE09RC.05
	NE19R
	NE19R.70
	NE20
	NE21
	DE09.05W
	DE09.08W
	DE09R.W
	DE09R.05W
	DE09R.08W
	DE18M.W(II)
	DE18M.08W(II)
	DE19.W
	DE19R.W
	DE20.W
	DE21.W

Module type	Module code
Dual glass products	DEG9R.20
	DEG9R.28
	DEG9RC.27
	DEG18M.20(II)
	DEG18M.28(II)
	DEG18MC.20(II)
	DEG19C.20
	DEG19RC.20
	DEG20C.20
	DEG21C.20
	NEG9.20
	NEG9.28
	NEG9C.27
	NEG9R.20
	NEG9R.25
	NEG9R.28
	NEG9RC.20
	NEG9RC.27
	NEG18R.20
	NEG18R.25
	NEG18R.28
	NEG18RC.27
	NEG19C.20
	NEG19R.20
	NEG19RC.20
	NEG20C.20
	NEG21C.20
	DEG9R.20W
	DEG9R.28W
	DEG9RC.27W
	DEG18MC.20W(II)
	DEG19C.20W
	DEG19RC.20W
	DEG20C.20W
DEG21C.20W	
HEG21C.20	

Contents of this document are subject to change without notice.

For the latest document please refer to Trina Solar official website: www.trinasolar.com.

UM-M-0002/Ver. L Copyright © August, 2024. Trina Solar Co., Ltd.

Table of Contents

1	INTRODUCTION	1
2	SAFETY PRECAUTIONS.....	1
3	SITE SELECTION AND ANGLE.....	3
4	UNLOAD/TRANSPORTATION/STORAGE.....	4
5	UNPACKING INTRODUCTION	10
5.1	UNPACKING SAFETY.....	10
5.2	UNPACKING STEPS.....	12
6	INSTALLATION	14
6.1	INSTALLATION SAFETY	14
6.2	INSTALLATION METHOD	16
6.2.1	SCREW INSTALLATION	16
6.2.2	CLAMP INSTALLATION	19
6.2.3	SINGLE-AXIS INSTALLATION	28
6.3	GROUNDING	29
6.4	ELECTRICAL INSTALLATION.....	30
6.4.1	SAFETY INSTRUCTION	30
6.4.2	WIRING	31
6.4.3	FUSING.....	33
7	PV MODULE MAINTENANCE	33
7.1	VISUAL INSPECTION AND REPLACEMENT.....	33
7.2	CONNECTOR AND CABLE INSPECTION	34
7.3	CLEANING	34
7.4	WEEDING.....	36
8	REPORTING TECHNICAL ISSUES AND CLAIMS	36
	AMENDED EDITIONS AND DATES	37

1 INTRODUCTION

First, thank you for choosing our products. This manual shall only apply to the installation, maintenance and use of the 210 Vertex series solar modules manufactured by Trina Solar Co., Ltd. (hereinafter referred to as "Trina Solar"). Failure to follow these safety instructions may result in personal injury or property damage.

The installation and operation of solar modules requires specialized skills and should only be performed by professionals. Please read the "Safety and Installation Instructions" carefully before using and operating the modules. The installer must inform the end customers (or consumers) of the above matters accordingly.

The term "Module" or "PV Module" in this manual refers to one or more 210 Vertex series solar modules. Please retain this manual for future reference.

DISCLAIMER

Trina Solar reserves the rights to change this User Manual without noticing in advance. This User Manual is not a warranty document and does not have any warranty meaning. Failure of the customers to follow the requirements outlined in this User Manual during the handling (including without limitation to packing/unpacking, loading/unloading, transportation, storage, installation, use, operation or maintenance, etc.) of the products will result in the invalidity of product's limited warranty. Trina Solar is not responsible for any damages of any kind, including but not limited to any product damages, personal injury or any other property losses, as resulting from any improper operations or faults by the customers during the handling of the products as failure to follow the instructions in this User Manual.



Warning

Otherwise, the product may be damaged or the user's personal safety may be endangered.



Prohibition

Otherwise, the product may be damaged or the user's personal safety may be endangered.

2 SAFETY PRECAUTIONS

GENERAL SAFETY

Before attempting to install, wire, operate and maintain the modules, please read and understand all safety instructions. The module's solar cell will generate direct current (DC) when it is exposed to direct sunlight or other light sources, and direct contact with electricity live parts of the module, such as terminals, can result in injury or death, irrespective of whether or not the module and the other electrical equipment are connected.

Regardless of whether the PV module is connected to the system or not, when conducting such as installation, grounding, wiring, or cleaning work, appropriate protective equipment such as insulation tools, hard hats, insulated gloves, safety belts and safety insulated shoes should always be used to avoid direct contact with the modules, reduce the risk of electric shock and protect your hands from sharp edges.





Do not stand, sit, walk, or jump directly on the module package or the module itself.

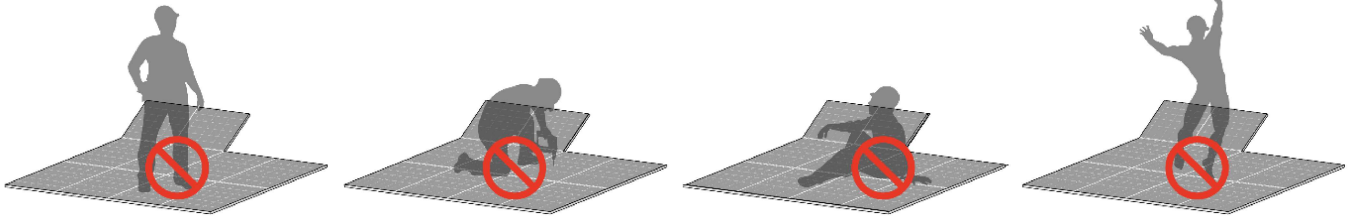

The PV module does not contain any serviceable parts. Do not disassemble or move any part of the module.

Do not damage or scratch the front- or backside surfaces of the module, as scratches may directly affect the product safety. If you detect any scratches or cuts on the module front- or backside, please do not use the module at all.

Do not put heavy objects or sharp objects on modules.

Do not lift the module by directly lifting or pulling the junction box or connector cables.

Do not pull, scratch or bend the output cables with force. Otherwise, the insulation part of the output cables will be damaged, leading to current leakage or electric shock.

Do not insert any conductive material into the connectors attached to the module.

Do not connect or disconnect the module when there is a current flow, or connected with any powered system.

Do not use water to extinguish fires when the module is connected to any powered system.

Do not artificially concentrate sunlight on the module.

Do not drop PV modules or allow objects to hit or fall directly on the modules.

Do not carry modules on your head.

Do not carry modules with ropes.

Do not carry modules on your back.

During the normal operation of modules, they should not be blocked by buildings, trees and vegetation, chimney pylons, overhead lines, neighboring arrays, etc. at any time of the day.

Keep the junction box cover closed at all times.

Protect junction box or connector from coming into contact with oil-based substances, organic solvents, other corrosive materials, or other substances that may cause malfunction. Further use is not allowed if junction box and connectors are contaminated.

Do not expose junction box and connectors directly to sunlight and protect them from water immersion.

Under normal conditions, a solar photovoltaic module is likely to experience conditions that produce more current and/or voltage than reported at standard test conditions. The requirement of National Electric Code (NEC) in Article 690 shall be following to address these increased outputs. In installation not under the requirement of the NEC, the values of I_{sc} and V_{oc} marked on this module should be multiplied by a factor of 1.25 when determining component voltage ratings, conductor current ratings, fuse sizes and size of controls connected to the PV output. Factors to consider include module temperature and front side irradiance (and, for bifacial modules, ground or roof albedo, row spacing, and installation height). Accordingly, the values of V_{OC} and I_{SC} (or for bifacial

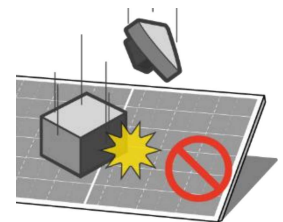
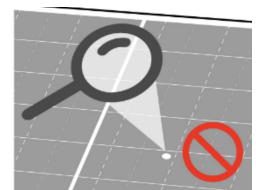
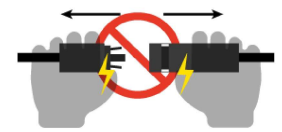
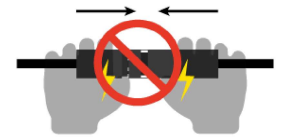

modules, ISC-aBSI) marked on this PV module should be multiplied by a factor of 1.25 when determining voltage and current ratings for components connected to the PV output.

Modules equipped with PV wiring connectors that comply with the Standard for Connectors for Use in Photovoltaic Systems, shall have the specific allowable mating connector manufacturer(s) and model number(s) listed in Appendix 1.

Modules equipped with PV wiring Cable that comply with the Standard for cable for Use in Photovoltaic Systems, shall have the specific allowable mating cable manufacturer(s) and model number(s) listed in Appendix 2.

FIRE SAFETY

When install modules on the rooftop, please refer to local laws and regulations before installation and abide by the requirements on building fire protection. The roof should be covered with a layer of fireproof materials with suitable fire protection rating and make sure that the backsheet and the mounting surface are fully ventilated. Different roof structures and installation methods will affect fireproof performance of buildings. Improper installation may lead to the risk of fire. Please use proper module accessories such as fuse, circuit breaker and grounding connector according to local regulations.

According to the Standards of UL 790, For single Glass PV module, the Spread of flame test Specification: Class C and the Burning brand test Specification: Class C; or Double Glass PV module, the Spread of flame test Specification: Class A and the Burning brand test Specification: Class C.



The customer must ensure that the PV modules are installed and used in a safe location in accordance with local laws and regulations.

Do not install or use modules near open flames or flammable and explosive materials. When installing PV modules near flammable and explosive locations, it is important to ensure that the fire separation distance is not less than 30 metres, and to increase the fire separation distance if necessary.

If the modules are to be installed near flammable and explosive locations (e.g. oil and gas stations, combustible dust areas, chemical storage areas, etc.), it is necessary to consult Trina Solar's sales and technical service team in advance.

3 SITE SELECTION AND ANGLE

INSTALLATION ENVIRONMENT SELECTION

Trina Solar recommends that the module should be installed in a operation environment with an ambient temperature of -40°C to 70°C .

The modules shall be installed in shadow-free areas throughout the year. Although the modules are equipped with bypass diodes, shadows will still affect the performance and safety of the modules, and may cause accelerated ageing of the encapsulation material and place thermal stress on the bypass diodes. This would lead to a significant reduction in module life and void the warranty. The negative effects of shading can be effectively reduced or eliminated by the use of power optimizers, microinverters, etc.

Do not install modules where there is a risk of water immersion or continuous exposure to sprinklers or fountains. When installing solar modules on the rooftop, a safe working area must be left between the roof edge and the outer edge of the PV array.

When stacking module on the rooftop, the rooftop should be tested for such loading and the installation plan must be developed in accordance with the specification requirements.

When using the modules in areas with high wind load and snow load, the supporting structure design should be carried out in strict accordance with the local design specifications, to ensure that the external load does not exceed the mechanical strength limit that the modules can withstand.

Salt spray corrosion tests conducted in accordance with IEC 61701 have shown that Trina Solar's PV modules can be installed near offshore or in the corrosive environment. However, the modules shall not be immersed in water or in a permanently wet environment (e.g., fountains, spindrift, etc.). There is a risk of corrosion if the module is placed in a salt spray (i.e., a marine environment) or in an environment containing sulfur (e.g., volcanoes, etc.).

In the place, 50~500 m away from the sea, stainless steel or aluminum materials need to be used in where contacting PV modules, and the installation position must be processed with anti-corrosion treatment. For detailed installation requirements, please refer to the *Trina Solar Coastal Application White Paper*, available from <https://www.trinasolar.com/en-glb/resources/downloads>.

As described in IEC TS 63126, based on geographic areas, mounting conditions and system design and installation factors, where the anticipated 98th percentile module operating temperature will be lower than 70°C, PV modules and all the equipment are rated to operate at an altitude less than 2 000 m above sea level $\leq 2000\text{m}$.

INCLINATION SELECTION

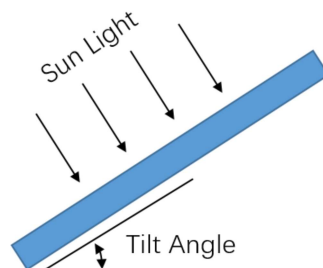

The tilt angle of the PV module refers to the angle between the module and the horizontal ground. The tilt angle shall be selected according to the local conditions for different projects. Trina Solar recommends that the mounting tilt angle should not be less than 10°. For specific tilt angles, it shall be chosen in accordance with the local design procedures, specifications and regulations, or following the recommendations of the experienced PV module installers.

The PV modules is highly recommended facing south in the northern hemisphere and north in the southern hemisphere to get the best performance.

Following the local regulations, if PV modules are installed in North America and any other country or region comply to UL standard. A minimum of 100mm (3.94 inch, recommended value) clearance shall be left between the PV module (backside) and the wall or roof surface. If other installation methods are used, the PV module's UL certification or fire class rating may get affected.

4 UNLOAD/TRANSPORTATION/STORAGE

In any circumstances, for vertical landscape packages, it shall not be stacked more than two layers; for vertical portrait packages, stacking is not allowed.

The working ground needs to ensure that the packaging box can be placed horizontally and steadily to avoid tipping.

Example for vertical landscape package and vertical portrait package is shown as follows:

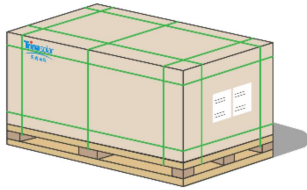

Vertical landscape package
(short-side vertically placed)



Vertical portrait package
(long-side vertically placed)

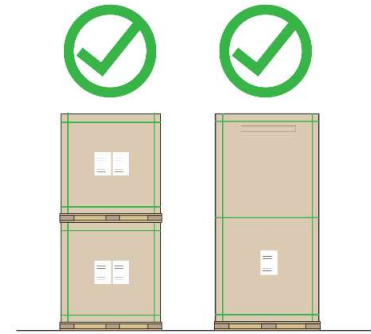

UNLOADING

Upon arrival of the modules, please check the packaging box is in good condition, and check whether the module type and quantity on the outer packaging are consistent with the delivery order, if anything is wrong, please contact Trina Solar logistics and sales staff immediately.

1. Unloading with a crane

When crane is used to unload the modules, please choose and use specialized tooling according to the weight and size of the module. Do not use the rope or sling for direct lifting. It is recommended to use steel pipe with sufficient strength for hoisting. If it is not possible to use steel pipe on site, please contact Trina Solar customer service for the special working tools.

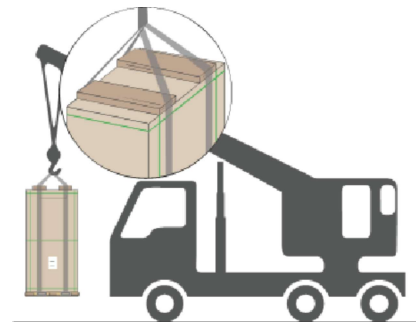

Please adjust the position of the sling to keep the modules steady. To ensure the safety of the module, wooden sticks, boards or other fixtures of the same width as the outer packing cases should be used on the upper part of the box to prevent the sling from squeezing the pallet and damaging the modules. When placing the modules, do not lower the packing box too quickly and put it on a flat ground.



For vertical landscape packages, do not lift up more than FOUR pallets of modules at once; for vertical portrait packages, do not lift up more than TWO pallets of modules at once.

Do not unload modules under the weather conditions of wind more than 6 class (in Beaufort scale), heavy rain or heavy snow.

2. Unloading with a forklift

The loading dock should be as the same height as the underside of the carrier.

Please keep sufficient safety space between forklift and personnel when the forklift is operating, prohibit people stand or walk around the forklift.

The forklift should be driven at a controlled driving speed of $\leq 5\text{km/h}$ in straight and $\leq 3\text{km/h}$ for turning, so as to avoid sudden stops and rapid starts to prevent modules from tipping to cause personnel injury.

Since the packing box will block the sight of the forklift driver, it is recommended to drive backwards during the forklifting, and arrange for special supervision and command to prevent bumping into people or items causing personal injury or damage to the modules.

Please choose a flat and solid ground to place the module package after transportation to the installation site.

Forklift operation in warehouse

When using a forklift to unload the modules, please choose a forklift with suitable tonnage according to module weight. The forks should go into the pallet at least 3/4 of the pallet depth during unloading (the forks length $L \geq 3/4$ of pallet length).

In order to ensure better stability during forklift transport, the forks distance (W) should be adjusted to the maximum position without any interference.

Please drive slowly and do not allow forks to hit the cartons or pallets. Please place buffer protection material (in yellow, preferably silicone, rubber, EPE) in advance to prevent the inside modules being damaged due to the external force.

It is recommended to extend the height or width of the forklift backrest to prevent directing touch with the module glass.



Please also pay attention to the following precautions when unloading (taking vertical portrait packages as an example).

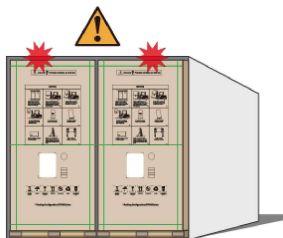

Prevent collision on the top when unloading from the container.

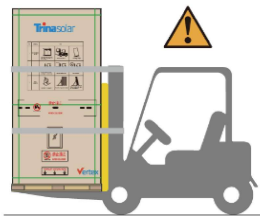

Recommend to secure the module package to the forklift with a safety rope, transport horizontally with no person standing on either side.

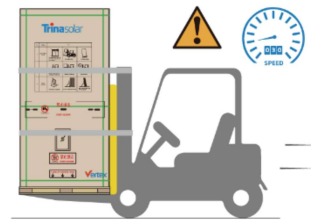

Control the speed to prevent tipping.

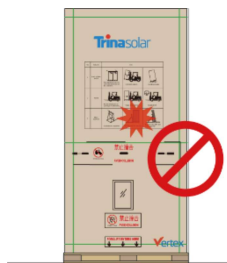

No collision on the module glass.

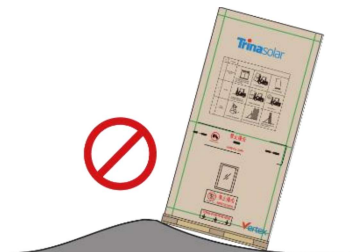

No tilting storage.

Forklift operation at project site

The forklift operation at project site refers to the transportation of modules between the storage site and the installation site after they arrived at the project storage site.

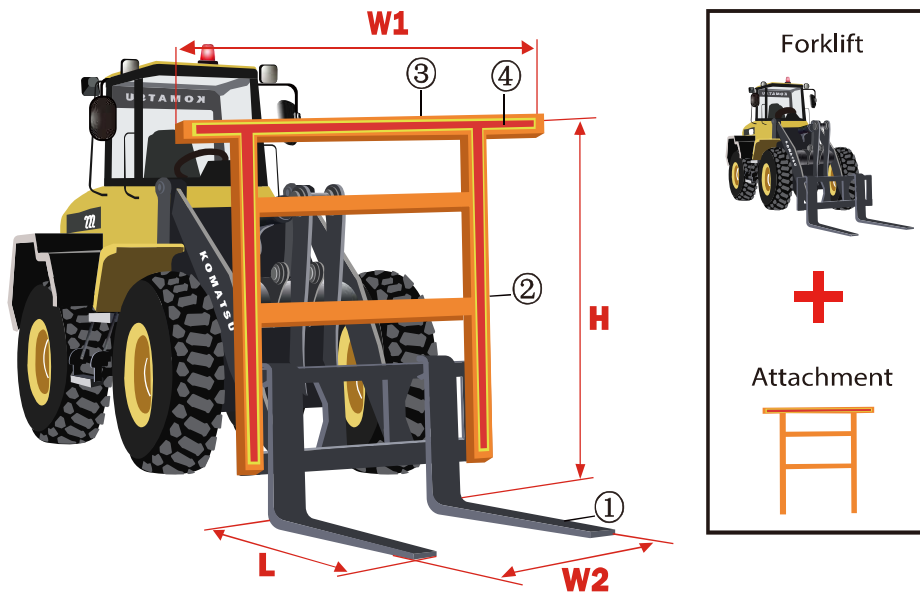

Forklift requirements:

Please use forklifts with a rated lifting capacity of ≥ 3.5 tons to load and transport the modules.



Do not allow the convex part of the fork to directly contact with the carton or modules to prevent damage to the modules.

Vertical portrait package

① Forks

The fork length (L) should ≥ 1.0 m.

The forks distance (W2) should be adjusted to the maximum position without any interference to the pallet.

② Backrest

The backrest length (H) should ≥ 1.7 m; the backrest width (W1) should ≥ 1.5 m.

The backrest shall perpendicular to the fork, and the structure must be firm (withstand pressure ≥ 15 kN). When the entire module package leans on the backrest, the backrest shall not be deformed due to pressure.

③ Beam

④ Buffer material

The contact position between the top beam and the module package should be fixed with a buffer material (preferably silicone, rubber, EPE) to prevent the forklift from damaging the modules.

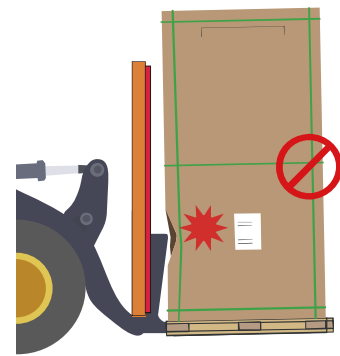

Vertical landscape package

① Forks

The fork length (L) should ≥ 1.0 m. The forks distance (W2) should be adjusted to the maximum position without any interference to the pallet.

② Backrest

The backrest length (H) should ≥ 1.5 m or the backrest width (W1) should ≥ 2.5 m.

The backrest shall perpendicular to the fork, and the structure must be firm (withstand pressure ≥ 15 kN). When the entire module package leans on the backrest, the backrest shall not be deformed due to pressure.



③ Beam

④ Buffer material

The contact position between the top beam and the module package should be fixed with a buffer material (preferably silicone, rubber, EPE) to prevent the forklift from damaging the modules.

**Forklift specifications and operating practices include, but are not limited to, the above-mentioned matters.*

Please also pay attention to the following precautions:

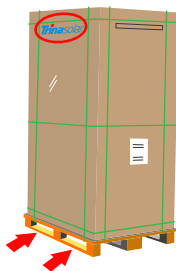

The forklift must be operated from the long side of the pallet (forks enter slowly into the pallet from the long side). Do not collide with the module. Both sides of the beam shall contact with the package at the same time.



The module package shall lean on the backrest, the package must be fixed using a safety rope with a tensile strength of ≥ 2000 kgf, and control the speed to prevent tip-off.



Place the module package smoothly on the ground, untie the safety rope after the confirmation of no risk of tilting.



Exit the forklift slowly.

SECONDARY TRANSPORTATION

The packaged modules can be transported by land, sea or air. During transportation, make sure that the package is fixed with packing belts securely on the shipping platform without any movement.

If the unpacked modules need to be transported to other places, it is recommended to pack the single module together in a package to the maximum number allowed, and fixed with inner packing belts (2100N force recommended). Finally, cover it with the packaging carton box and fix it with the same number of packing belts as before.

If the number of modules need to be packed is less than the maximum number allowed in a package, the modules need to be fixed and secured to the center of the pallet for utility packaging (the following figure to the left) or on the side for distribution packaging (the following figure to the right), and fixed with inner packing belts (2100N force recommended). Finally, cover it with the packaging carton box and fix it with the same number of packing belts as before. Do not put the unfulfilled package on the lower layer when transported.

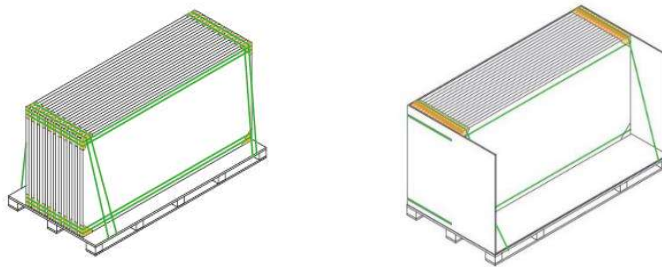

Please use appropriate means of transport to transport the modules. Do not use pedicab to transport or handle the modules.

Secondary transport is not allowed for the monofacial modules that are packaged horizontally.

There is no stacking of pallets allowed (for both vertical landscape and vertical portrait packages), when transporting with small trucks. Please fix the package to the vehicle using e.g. safety ropes and control the driving speed according to the road conditions. Please put paper corner support or other buffer material between safety rope and carton box to protect modules from damage.

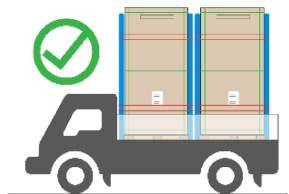

When using box trucker and flatbed trucker transport the modules, the module packages should be placed close to each other without any gap. The empty space needs to be filled to prevent the package moving backwards to the rear of the truck. Additionally, every package needs to be fixed using e.g. ropes to the vehicle when transporting with the flatbed trucker.

Do not allow pallets to exceed the loading area of the transport vehicle.

STORAGE

Modules should be stored in a dry and ventilated environment on a flat ground (for vertically portrait package, the inclination of ground need to be less than 8°), to avoid damage or dumping of the modules due to ground deformation or collapse.

Storage requirements: relative humidity < 85% and temperature range of -40°C to 50°C.



Do not remove the original package and keep the wrapping film and carton box in a good condition, if the modules require long-distance transport or long-term storage.

For long-term storage, it is recommended to store the modules in a standard warehouse with regular inspection, and under confirming of your personal safety, reinforce the package in a timely manner if any anomalies are found.

The warehouse shelves should have sufficient carrying capacity and storage space, regular inspection is required to ensure the storage safety.

If you need to store the modules in the project site, do not choose soft ground and the ground that is easy to collapse, should choose a hard ground or a higher ground with flat surface to ensure the module packages not collapsing and tilting for long-term storage.

In rainy weather, please fully cover the modules and pallets with a rain protection and take moisture-proof measures on pallets and cartons to prevent collapse and moisture ingress. Under sun or wind, remove the rain cloth to allow the package to dry as soon as possible, prevent package collapse caused by the rain.

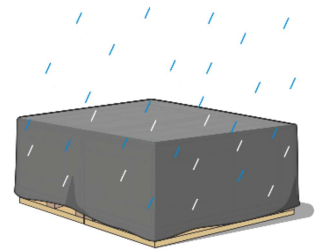

Do not allow the pallets to soak in water. The ground drainage measures should be done previously for the storage site to prevent a large amount of water accumulation on the ground after rain, causing the ground to soften, sink, etc.

Do not allow unauthorized persons to access the module storage area.

The modules should be centrally stored.

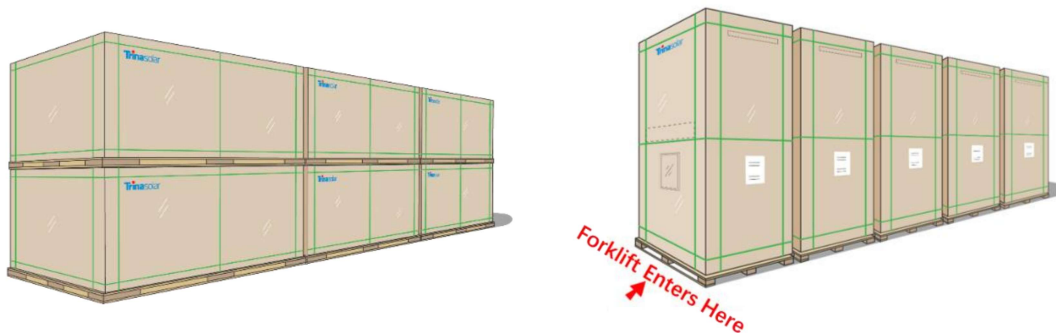

5 UNPACKING INTRODUCTION

5.1 UNPACKING SAFETY

Before unpacking, please check the product type, power bins, serial number and relevant suggestions on the A4 paper of the packaging box, and read the unpacking instructions carefully. Custom unpacking methods are prohibited.

Before unpacking, please make sure that the packaging box is in good condition, it is recommended to use art knife to remove the packing belt and wrapping film. Violent removal is prohibited to avoid scratching the modules in the box.

Please check that the number of modules in the box and the barcode information on the module frame are consistent with the information on the A4 paper on the packaging box.

Please follow the recommended unpacking steps to unpack the modules. When unpacking, it must be operated by two or more people at the same time. Always wear insulating gloves when handling the modules.

If all the modules are not taken out after unpacking, the remaining modules shall be placed horizontally and repackaged to prevent them from tipping. When packaging, please note that the glass side of the bottom module should face up, the glass side of the middle modules should face down, and the glass side of the top module should face up. Stacks of modules should contain no more than 16 modules, and the frames should be aligned.

If the unpacked modules are not installed immediately, they should be fixed to the stand supporter with a safety rope under weather of 6 class wind (the modules should be less than 12 pieces).

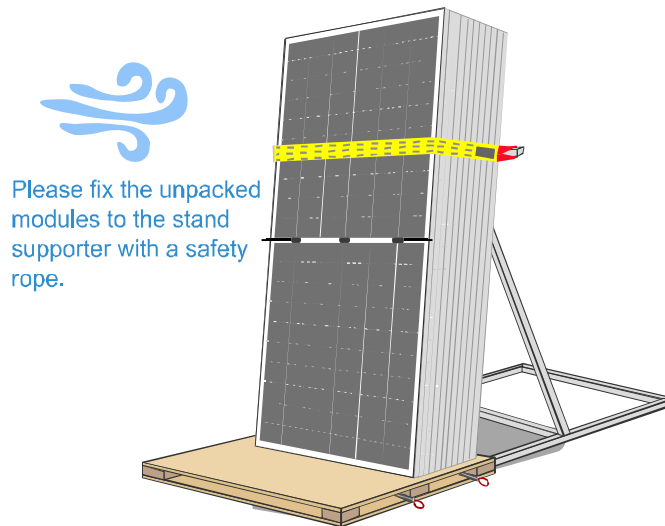

For matters regarding the unpacking stand supporter, please contact Trina Solar sales.

In windy weather, it is recommended not to carry the modules, and the unpacked modules should be properly secured.

Do not unpack the modules outside under rain and snow conditions.

Do not carry the module by one person to prevent the module from slipping and hitting other modules, causing scratches, cracks, or deformation on the modules.

Do not lift modules by their cables or junction box.

Before removing the inner packing belts, please take measures to protect the modules from dumping.

If unpacking the vertical landscape packages on non-horizontal ground, anti-tilting measures should be taken.

The vertical portrait packages have a high center of gravity and are prohibited to unpack on non-horizontal or soft grounds to avoid personal injury or even death.

When unpacking vertical portrait package, do not stand on the back of the stand supporter, please operate in strict accordance with the requirements of the unpacking instructions.

When removing the packing belts in vertical portrait package, take care not to hurt yourself (face, eyes, etc.).

Do not stand on the pallet during unpacking, please carry the modules from sides of the pallet.

Do not move the stand supporter during unpacking to prevent the modules being tilted.

Do not lean the module on any instable objects, such as poles or mounting columns.

Do not support the back of the modules directly with materials such as wooden strips.

5.2 UNPACKING STEPS

Method A: Unpacking for DE20 / DE21 / DEG21C.20 / NE20 / NE21/ NEG21C.20/ HEG21C.20 / DE20.W/ DE21.W/ DEG21C.20W etc. series modules with vertical portrait package.



1) Remove the wrapping film and packing belts.

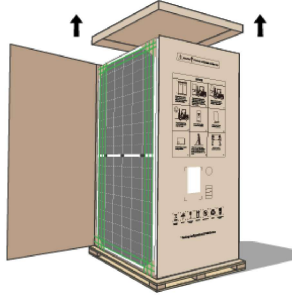

2) Remove the top cover and sealing tape.

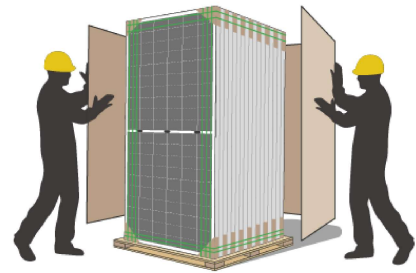

3) Remove the carton box.



4) Place the stand supporter from the glass or backsheet side.

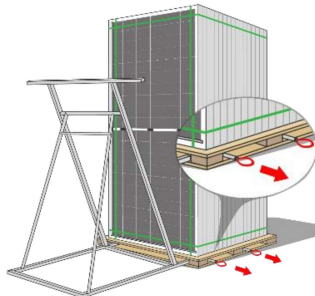

5) Pull out the 4 levers from both sides of the pallet.



6) Cut off all the horizontal packing belts.



7) When there are 1-2 vertical packing belts remaining, push the module gently to tilt toward the stand supporter.



8) Cut off the remaining packing belts so that the modules rest on the stand supporter.

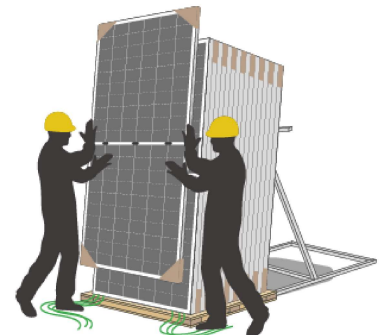

9) Take out the modules in order.

Method B: Unpacking for vertical landscape package: DE18M(II) / DE18M.08(II) / DEG18MC.20(II) / DEG18M.20(II) / DEG18M.28(II) / DE19 / DEG19C.20 / DE19R / DEG19RC.20 / NEG18R.20 / NEG18R.25 / NEG18R.28 / NEG18RC.27 / NE19R / NE19R.70 / NEG19C.20 / NEG19R.20 / NEG19RC.20 / DE18M.W(II) / DE18M.08W(II) / DEG18MC.20W(II) / DE19.W / DEG19C.20W / DE19R.W / DEG19RC.20W / DE20.W / DEG20C.20W / DE21.W / DEG21C.20W etc. series modules; and DE20 / DEG20C.20 / DE21 / DEG21C.20 / NE20 / NEG20C.20 / NE21 only for China

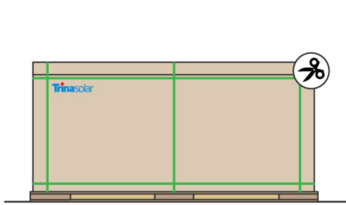

1) Remove the wrapping film and packing belts.

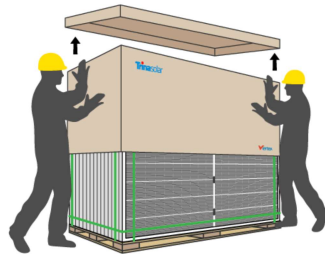

2) Remove the top cover and the cartons.



3) Place the stand supporter that is higher or wider than the module in order to avoid hitting and damaging the glass.

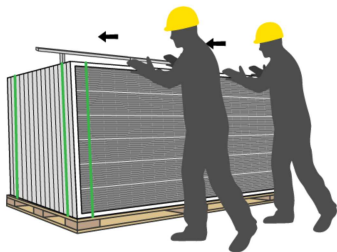

4) Cut off all the horizontal packing belts; when there are 1 or 2 vertical packing belts remaining, push the module gently to tilt toward the stand supporter.

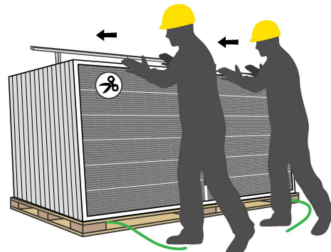

5) Cut off the remaining packing belts.

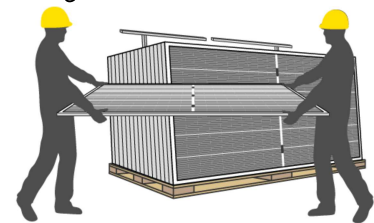

6) Take out the modules in order.

Method C: Unpacking from one side for DE09 / DE09.05 / DE09.08 / DE09R / DE09R.05 / DE09R.08 / DE09C.05 / DE09C.07 / DEG9R.20 / DEG9R.28 / DEG9RC.27 / NE09RC.05 / NEG9.20 / NEG9.28 / NEG9C.27 / NEG9R.20 / NEG9R.25 / NEG9R.28 / NEG9RC.20 / NEG9RC.27 / DE09.05W / DE09.08W / DE09R.W / DE09R.05W / DE09R.08W / DEG9R.20W / DEG9R.28W / DEG9RC.27W etc. series modules with vertical landscape package.

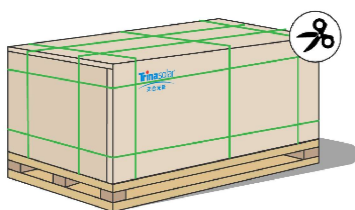

1) Cut all the packing belts and take out the wrapping film.

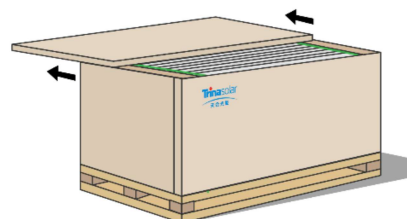

2) Remove the top cover.

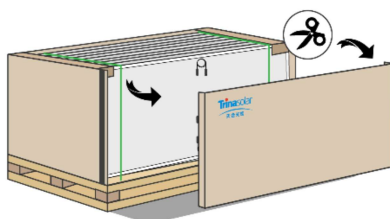

3) Remove the side cover.

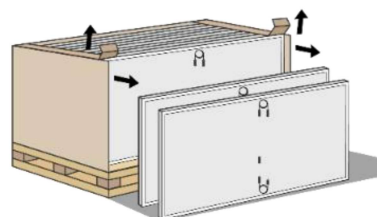

4) Take out the modules from one side.

6 INSTALLATION

Mechanical drawing for monofacial modules

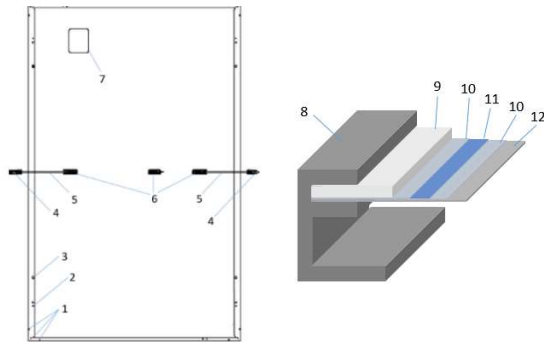

- 1 Drain hole
- 2 Grounding hole
- 3 Installation hole
- 4 Connector
- 5 Cable
- 6 Junction box
- 7 Nameplate

Mechanical drawing for bifacial modules

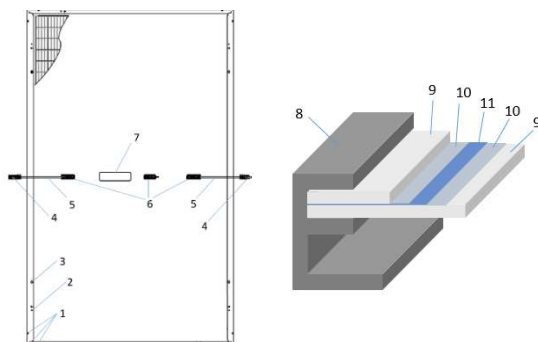

- 8 Frame
- 9 Glass
- 10 Encapsulate material
- 11 Solar cell
- 12 Backsheet

6.1 INSTALLATION SAFETY

Trina Solar recommends that PV module installation should only be conducted by specialized persons with experience in PV system installation. All installation work must be in full compliance with the local regulations and the relevant international electrical standards.

The fire rating of Trina Solar modules complies with relevant standards or local laws and regulations.

Before installation, please carefully check the modules for abnormalities such as glass bursts, cell cracks, backsheet scratches, deformation of installation holes, broken junction boxes or missing covers, nameplates falling off or missing, and broken cables or connectors, etc. If any of such situation is found, please contact Trina Solar customer service in time.

Before installation, remove the corner protectors and tapes for assembly and component protection.

Before installation, please keep modules' electrical components clean and dry. Connectors can corrode if they are in connected under wet conditions or with water inside the conductive parts. Any corroded components shall not be used.

The cable length of junction box shall be selected according to the installation mode. When wiring, the ties for fixing the cables coils shall be removed. The cable shall be fixed on the installation system (frame or bracket, guide rail) with UV resistant cable ties, in cable conduits or wire cards to avoid direct sunlight or immersion in water and mechanical damage of the cable; otherwise, it may cause accelerated aging of the cable or even leakage and fire. Bifacial PV modules should also avoid blocking the solar cells on the back of the module. The open area should minimize arc coil, which can reduce the risk of induced lightning impact on PV module.

Before the installation is completed and put into use, the integrity of the module's appearance should be checked again and the surface should be free of obscuring. Any of the following anomalies should be prohibited for further use, including: glass bursts, cell cracks, backsheet scratches, deformation of installation holes, broken junction boxes or missing covers, nameplates falling off or

missing, and broken cables or connectors, etc. Confirm that the mechanical and electrical systems comply with the requirements and recommendations of this manual, and carry out a trial run to ensure the integrity and safety of functions.



Do not install modules under rain, snow or windy conditions.

If installing or operate modules after rain or in the morning dew, appropriate protective measures need to be taken to prevent water vapor from penetrating into the connector.



Do not allow unauthorized persons to access the installation area.

When installing with scaffolding, make sure that the scaffolding is in a stable position or with anti-dumping measures, and that the installer should wear a safety belt in accordance with local building codes.

It is recommended not to stand on the bottom side of the inclined surface of the module during installation, to prevent the module from slipping and causing casualty.

Please keep the PV module packed in the carton until installation and install them immediately after unpacking.

Do not wear metallic jewelry which can cause electric shock during installation.

During installation and wiring of PV modules, please use opaque material to cover the PV module surface completely.

Installation work must be carried out by at least two persons.

Do not stand on the module glass while working. There is a risk of injury or electric shock if the glass is broken.

Do not loosen or unscrew the screws/clamps/rails of and around the PV module, which may lead to a reduction of the module's load rating and even fall off.

Do not drop any tools or other objects on the module front- or backside which could cause damage (visible or non-visible) to the module.

Do not install or use damaged modules. If the surface glass is damaged or worn, direct contact with the surface of the module may cause electric shock.

Do not damage the backsheet or glass of modules when fastening the modules to the bracket with bolts.

Do not drill additional holes on any part of the module. Doing so will void the warranty.

The drain holes on the module frame must not be blocked in any situation during the installation and operation.

Do not unplug the connector if the system circuit is connected to a load.

Modules with different colors should be avoided to install on the same rooftop or in the same array.

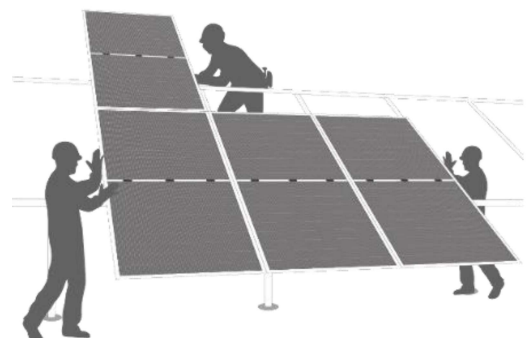

6.2 INSTALLATION METHOD

The PV modules must be installed in accordance with the installation instructions specified in this user manual to comply with the IEC certification. Before installing, please read this section carefully to familiarize yourself with the complete installation processes.

The modules and racking system can be connected through the mounting holes, clamps, or an embedded system. Installation of modules must be carried out in accordance with the installation requirements. If you wish to use a different installation method, please consult Trina Solar customer service or technical support team. If in such case that an alternative mounting method is used but not approved by Trina Solar, the module may get damaged and the warranty will be invalidated.

The mechanical loads described in this manual are the test loads. For calculating the equivalent maximum design loads, a safety factor of 1.5 (Mechanical loads=Design loads×1.5 security coefficient) needs to be considered in compliance with the requirements of the local laws and regulations. The design loads are strongly related to the construction, applied standards, location and local climate conditions; therefore, have to be determined by the racking suppliers and/or the professional engineers. For detailed information, please follow local structural code or contact your professional structural engineer.

The minimum distance between two modules is 5 mm (0.2 inch). If using special trackers, the minimum distance should be selected according to the technical requirements of the tracker suppliers.

Trina Solar is not responsible in any way for module installation failures caused by clamps, trackers, etc..

The modules below have been evaluated by TUV according to IEC61215.

Module type	Mechanical loads (1.5 security coefficient)
DE19R/ DE20/ DEG20C.20/ DE21/ DEG21C.20/ NEG18R.20/ NEG18R.28/ NE19R/ NE19R.70/ NEG19R.20/ NEG19RC.20/ NE20/ NEG20C.20/ NE21/ NEG21C.20	negative design loading≤1600 Pa positive design loading≤3600 Pa
DE18M(II)/ DE18M.08(II)	negative design loading≤1600 Pa positive design loading≤4000 Pa
DE09R/ DE09R.05/ DE09R.08	negative design loading≤2667 Pa positive design loading≤4000 Pa
NEG9R.20/ NEG9R.25/ NEG9R.28/ NEG9RC.20/ NEG9RC.27	negative design loading≤2667 Pa positive design loading≤3600 Pa

6.2.1 SCREW INSTALLATION

The frame of each module has 4-φ9*14mm mounting holes, that are ideally placed to optimize the loading capacity to secure the modules on the supporting structure.

To maximize mounting longevity, Trina Solar strongly recommends the use of corrosion proof (stainless steel) fixings.

Secure the module in each fixing location with one M6/M8 bolt, two flat washers, one spring washer and one nut (see Figure 1) and tighten them to a torque of 10-14 N.m (90-125 lbf.in.). The yield strength of bolt and nut should not be less than 450 MPa.

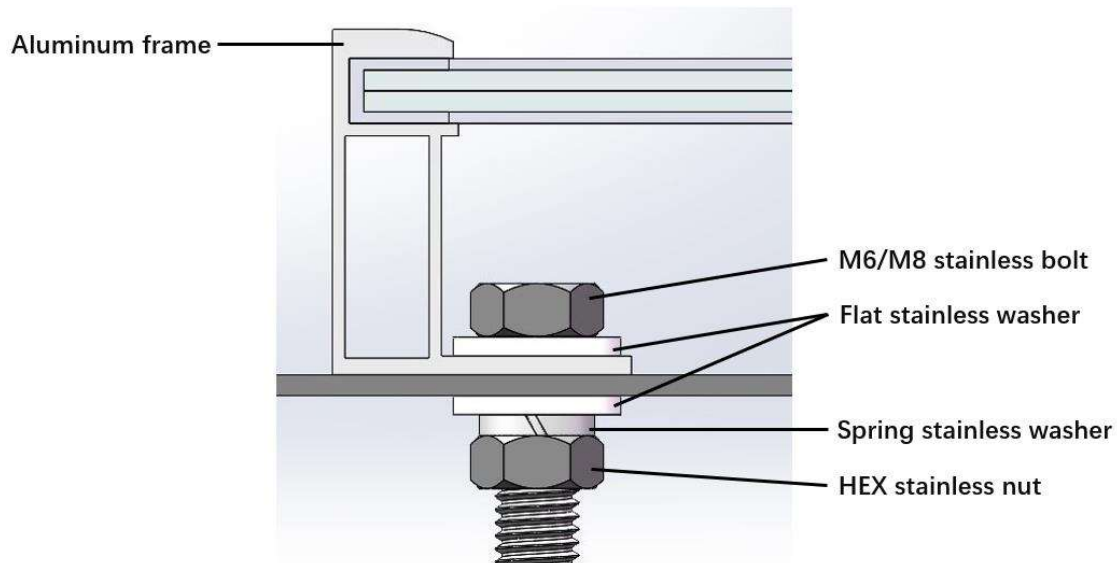
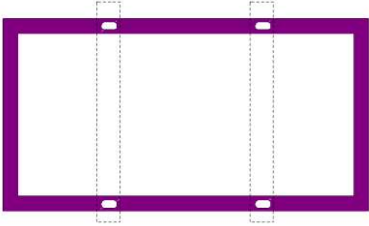



Figure 1. PV module installed with bolt fitting method.

Product code	Requirement
DE09 / DE09.05 / DE09.08 / DE09C.05 / DE09C.07 / DE18M(II) / DE18M.08(II) / DEG18MC.20(II) / DE19 / DE19R / DEG19C.20 / DEG19RC.20 / DE20 / DEG20C.20 / DE21 / DEG21C.20 / NEG18R.20 / NEG18R.25 / NEG18R.28 / NEG18RC.27 / NE19R / NE19R.70 / NEG9R.20 / NEG9R.25 / NEG9R.28 / NEG9RC.20 / NEG9RC.27 / NEG19C.20 / NEG19R.20 / NEG19RC.20 / NE20 / NEG20C.20 / NE21 / NEG21C.20 / HEG21C.20 / DE09.05W / DE09.08W / DE18M.W(II) / DE18M.08W(II) / DEG18MC.20W(II) / DE19.W / DE19R.W / DEG19C.20W / DEG19RC.20W / DE20.W / DEG20C.20W / DE21.W / DEG21C.20W	All parts in contact with the frame should use flat stainless-steel washers of a minimum of 1.5 mm (0.06 inch) thickness with an outer diameter of 16-18 mm (0.63-0.71 inch).
DE09R / DE09R.05 / DE09R.08 / DEG9R.20 / DEG9R.28 / DEG9RC.27 / DEG18M.20(II) / DEG18M.28(II) / NE09RC.05 / NEG9.20 / NEG9.28 / NEG9C.27 / DE09R.W / DE09R.05W / DE09R.08W / DEG9R.20W / DEG9R.28W / DEG9RC.27W	All parts in contact with the frame should use flat stainless-steel washers of a minimum of 1.5 mm (0.06 inch) thickness with an outer diameter of 19-20 mm (0.75-0.79 inch).

The screw should be fixed at the following locations for different installation methods and mechanical loads.

Module type	Mechanical loads	Module type	Mechanical loads
 <p>Mounting rails run parallel to the short side frame. Distance between mounting holes is 1400 mm. Distance between mounting holes is 1300 mm (for NEG18R series). Distance between mounting holes is 1100 mm (for DE09 series/DE09C series/DE09R series/DEG9R series/DEG9RC series/NEG9 series/ NEG9C series).</p>		 <p>Mounting rails run parallel to the long side frame. Distance between mounting holes is 1400 mm.</p>	
DE09 DE09.05 DE09.08 DE09R DE09R.05 DE09R.08 DE09C.05 DE09C.07 NEG9RC.05 DE09.05W DE09.08W DE09R.W DE09R.05W DE09R.08W DEG9R.20 DEG9R.28 DEG9RC.27 NEG9.20 NEG9.28 NEG9C.27 NEG9R.20 NEG9R.25 NEG9R.28 NEG9RC.20 NEG9RC.27 DEG9R.20W DEG9R.28W DEG9RC.27W	Uplift load ≤ 4000 Pa Downforce load ≤ 6000 Pa	DEG18MC.20(II) DEG19C.20 DEG19RC.20 DEG20C.20 NEG19C.20 NEG19RC.20 NEG20C.20 DEG18MC.20W(II) DEG19C.20W DEG19RC.20W DEG20C.20W DEG21C.20W	Uplift load ≤ 2400 Pa Downforce load ≤ 3600 Pa
DE18M(II) DEG18M.20(II) DEG18M.28(II) DEG18MC.20(II) DE19 DE19R DEG19C.20 DEG19RC.20 DE20 DEG20C.20 DE21 DEG21C.20 NEG18R.20 NEG18R.25 NEG18R.28 NEG18RC.27 NEG19C.20 NE19R	Uplift load ≤ 2400 Pa Downforce load ≤ 5400 Pa	DE21C.20 NEG21C.20	Uplift load ≤ 2400 Pa Downforce load ≤ 2800 Pa *Up to +3600Pa/-2400Pa provided, contact sales service for more information

NE19R.70 NEG19R.20 NEG19RC.20 NE20 NEG20C.20 NE21 NEG21C.20 DE18M.W(II) DEG18MC.20W(II) DE19.W DE19R.W DEG19C.20W DEG19RC.20W DE20.W DEG20C.20W DE21.W DEG21C.20W			
DE18M.08(II) DE18M.08W(II)	Uplift load \leq 2400 Pa Downforce load \leq 6000 Pa		

6.2.2 CLAMP INSTALLATION

Trina Solar has tested its modules with a number of clamps from different manufacturers, it is recommended to use fixing bolt of at least M8. The clamp shall not be malfunctioned due to deformation or corrosion during the loading process. It is recommended to use a clamp with length of ≥ 50 mm (1.97 inch) and thickness of ≥ 4 mm (0.16 inch), aluminum alloy 6005-T6, Rp0.2 \geq 225 MPa, Rm \geq 265 MPa. (The clamp shall be selected to guaranty the module installation reliability, recommended torque range is for reference only).

The clamp must overlap the A surface of module frame by at least 8 mm (0.32 inch) but not more than 12 mm (0.47 inch).

For installation where mounting rails run parallel to the frame, the frame must overlap the rails completely or the overlapping distance must ≥ 20 mm.

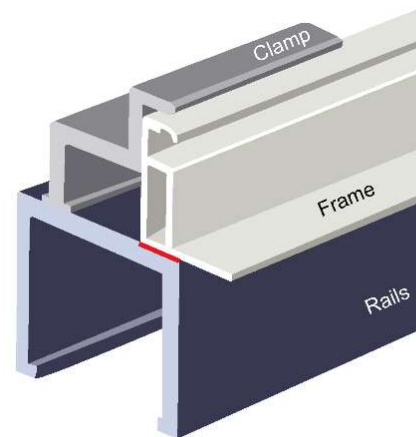

— The frame overlap the rails the overlapping distance must ≥ 20 mm.

Since the spec of clamps is not uniform in the market and the clamps have a large impact on the wind load resistance in system side, it is recommended to follow the recommendation of Trina Solar to choose clamps. You can also customize the clamps by yourselves, but please make sure that the modules do not detach from the brackets and rails.

Modules clamps should not come into contact with the front glass and must not be deformed.

Please make sure to avoid shading effects from the module clamps.

The module frame shall not to be modified under any circumstances.

The clamps shall not to be out the edge of the module under any circumstances.

When choosing clamp installation method, use at least four clamps on each module. Depending on local wind and snow loads, additional clamps may be required to ensure that modules can bear the extra load.

Applied torque should refer to mechanical design standard according to the bolt customer is using, for example: M8: 10-14 N.m (90-125 lbf.in)

The installation method of clamps is shown in Figure 2.

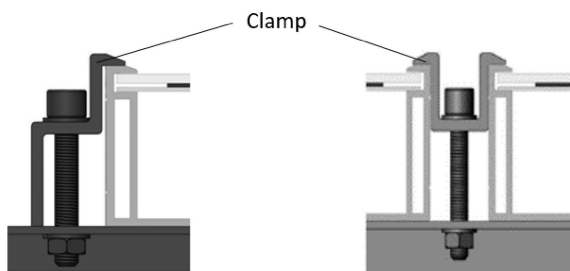

End clamp installation Middle clamp installation.

Figure 2. PV module installed with clamp fitting method

The "A surface Matching Clamp" has a bent hook structure where contacts with the frame to increase the friction, so it is recommended for customers to use this kind of clamps who have high requirements for mechanical loading. The specific dimensions of the clamp are shown in the figure below.

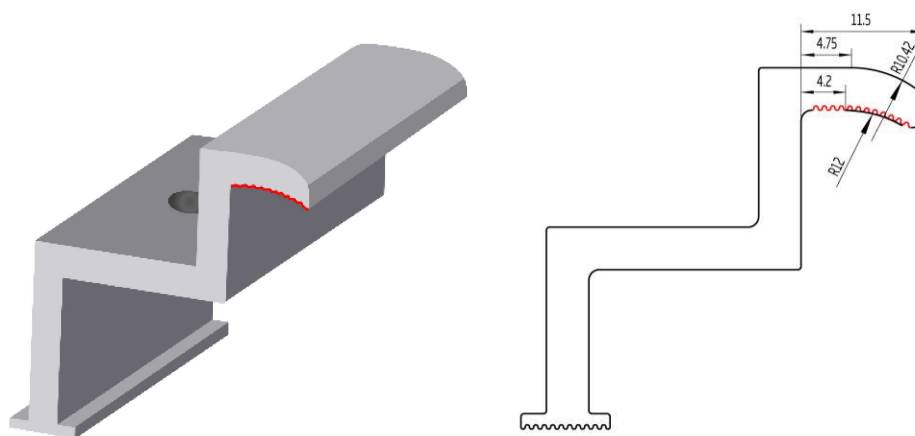

Figure 3. A surface matching clamp

Clamp positions are of crucial importance for the reliability of the installation. The clamp centerlines must only be positioned within the ranges indicated in table below, depending on the configurations and loads.

Module type	Mechanical loads	Module type	Mechanical loads
	<p>Use 4 clamps on the long side. Mounting rails run perpendicular to the long side frame.</p>	<p>Use 4 clamps on the long side. Mounting rails run parallel to the long side frame. Overlapping length(perpendicular to the long side direction) of mounting rails and long side of module no less than 20 mm</p>	

DEG18MC.20(II) DEG18MC.20W(II)	A = (350 - 450) mm Uplift load ≤ 2400 Pa Downforce load ≤ 5400 Pa	DEG18MC.20(II) DEG18MC.20W(II)	A = (350 - 450) mm Uplift load ≤ 2400 Pa Downforce load ≤ 3600 Pa
DEG18M.20(II) DEG18M.28(II)	A = (360 - 450) mm Uplift load ≤ 2400 Pa Downforce load ≤ 5400 Pa	DEG19C.20 DEG19RC.20 NEG19C.20 NEG19RC.20 DEG19C.20W DEG19RC.20W	A = (440 - 540) mm Uplift load ≤ 2400 Pa Downforce load ≤ 3600 Pa
NEG18R.20 NEG18R.28 NEG18R.28 NEG18RC.27	A = (305 - 405) mm Uplift load ≤ 2400 Pa Downforce load ≤ 5400 Pa	DEG20C.20 NEG20C.20 DEG20C.20W	A = (360 - 430) mm Uplift load ≤ 2400 Pa Downforce load ≤ 3600 Pa
DEG19C.20 DEG21C.20 NEG19C.20 NEG19R.20 NEG21C.20 DEG19C.20W DEG21C.20W	A = (440 - 540) mm Uplift load ≤ 2400 Pa Downforce load ≤ 5400 Pa	DEG21C.20W	A = (440 - 540) mm Uplift load ≤ 2400 Pa Downforce load ≤ 3600 Pa
DEG19RC.20 NEG19RC.20	A = (420 - 520) mm Uplift load ≤ 2400 Pa Downforce load ≤ 5400 Pa	DEG21C.20 NEG21C.20	A = (440 - 540) mm Uplift load ≤ 2400 Pa Downforce load ≤ 2800Pa *Up to +3600Pa/-2400Pa provided, contact sales service for more information
DEG19RC.20W	A = (400 - 440) mm Uplift load ≤ 2400 Pa Downforce load ≤ 5400 Pa	/	/
DEG20C.20 NEG20C.20 DEG20C.20W	A = (360 - 430) mm Uplift load ≤ 2400 Pa Downforce load ≤ 5400 Pa		
NE19R.70	A = (440 - 520) mm Uplift load ≤ 2400 Pa Downforce load ≤ 5400 Pa		

The following mounting method is recommended to use A surface matching clamp:

Module type	Mechanical loads	Module type	Mechanical loads
-------------	------------------	-------------	------------------

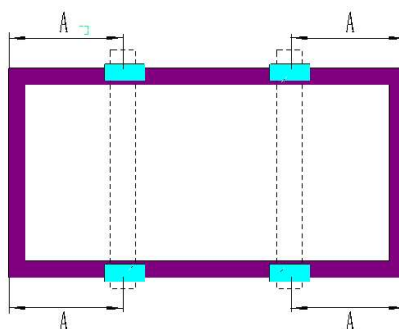





Use 4 clamps on the long side.

Mounting rails run perpendicular to the long side frame.

DE09 DE09.05 DE09.08 DE09C.05 DE09C.07 DE09.05W DE09.08W	A = (250 - 350) mm Uplift load \leq 4000 Pa Downforce load \leq 6000 Pa	NEG9R.20 NEG9R.25 NEG9R.28 NEG9RC.20 NEG9RC.27	A = (300 - 350) mm Uplift load \leq 4000 Pa Downforce load \leq 5400 Pa
DE09R DE09R.05 DE09R.08 NE09RC.05 DE09R.W DE09R.05W DE09R.08W	A = (250 - 330) mm Uplift load \leq 4000 Pa Downforce load \leq 6000 Pa	DEG9R.20 DEG9R.28 DEG9RC.27 NEG9.20 NEG9.28 NEG9C.27 DEG9R.20W DEG9R.28W DEG9RC.27W	A = (290 - 370) mm Uplift load \leq 4000 Pa Downforce load \leq 5400 Pa
DE18M(II) DE18M.W(II)	A = (350 - 450) mm Uplift load \leq 2400 Pa Downforce load \leq 5400 Pa	DE18M.08(II) DE18M.08W(II)	A = (350 - 450) mm Uplift load \leq 2400 Pa Downforce load \leq 6000 Pa
DE21 DE19.W DE19R.W DE21.W NE21	A = (440 - 540) mm Uplift load \leq 2400 Pa Downforce load \leq 5400 Pa	DE19 DE19R NE19R	A = (420 - 520) mm Uplift load \leq 2400 Pa Downforce load \leq 5400 Pa
DE20 DE20.W NE20	A = (360 - 430) mm Uplift load \leq 2400 Pa Downforce load \leq 5400 Pa		

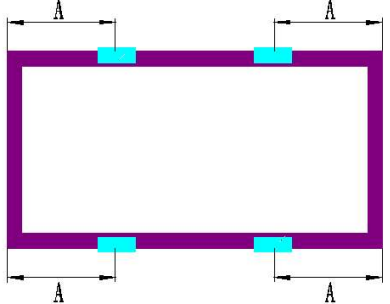
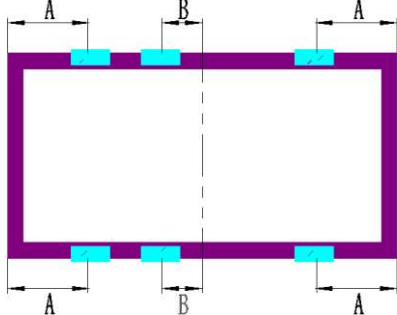
The following installation methods and mechanical loads have been verified by the Trina Solar's National Key Laboratory for PV Science and Technology.

Module type	Mechanical loads	Module type	Mechanical loads
 <p>Use 4 clamps on the short side. Mounting rails run perpendicular to the long side frame. Overlapping length(perpendicular to the short side direction) of mounting rails and short side of module no less than 20 mm</p>		 <p>Use 4 clamps on the short side.</p>	
DEG18MC.20(II) DEG18MC.20W(II)	A = (0 - 200) mm Uplift load ≤ 1000 Pa Downforce load ≤ 1300 Pa	DEG18M.20(II) DEG18M.28(II) DEG18MC.20(II) DEG18MC.20W(II)	A = (0 - 200) mm Uplift load ≤ 1000 Pa Downforce load ≤ 1300 Pa
NEG18R.20 NEG18R.25 NEG18R.28 NEG18RC.27	A = (0 - 200) mm Uplift load ≤ 1000 Pa Downforce load ≤ 1300 Pa	NEG18R.20 NEG18R.25 NEG18R.28 NEG18RC.27	A = (0 - 200) mm Uplift load ≤ 1000 Pa Downforce load ≤ 1300 Pa
 <p>Use 4 clamps on the long side.</p>		 <p>Use 6 clamps on the long side.</p>	
DEG18M.20(II) DEG18M.28(II) DEG18MC.20(II) DEG18MC.20W(II)	A = (200 - 600) mm Uplift load ≤ 1700 Pa Downforce load ≤ 1700 Pa	DEG18M.20(II) DEG18M.28(II)	A = (0 - 200) mm B = (0 - 200) mm Uplift load ≤ 1800 Pa Downforce load ≤ 2400 Pa
NEG18R.20 NEG18R.25 NEG18R.28 NEG18RC.27	A = (230 - 480) mm Uplift load ≤ 1700 Pa Downforce load ≤ 1700 Pa	NEG18R.20 NEG18R.25 NEG18R.28 NEG18RC.27	A = (230 - 480) mm B = (0 - 250) mm Uplift load ≤ 1800 Pa Downforce load ≤ 2400 Pa
DEG19RC.20 NEG19RC.20	A = (450 - 650) mm Uplift load ≤ 2200 Pa Downforce load ≤ 2400 Pa	/	/

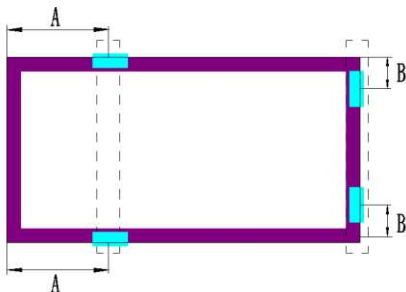

 <p>Slide-in rails on the short side.</p>	 <p>Use 2 clamps on the short side and 2 clamps on the long side. Mounting rails run perpendicular to the long side frame.</p>
--	--

DEG18MC.20(II) DEG18MC.20W(II)	Uplift load ≤ 1000 Pa Downforce load ≤ 1000 Pa	DEG18MC.20(II) DEG18MC.20W(II)	$A = (250 - 450)$ mm $B = (100 - 250)$ mm Uplift load ≤ 1000 Pa Downforce load ≤ 1300 Pa
-----------------------------------	---	-----------------------------------	---

 <p>Use 4 clamps on the short side. Mounting rails run parallel to the long side frame.</p>	/	/
--	---	---

NEG18R.20 NEG18R.25 NEG18R.28 NEG18RC.27	$A = (55 - 100)$ mm Uplift load ≤ 1000 Pa Downforce load ≤ 2400 Pa	/	/
---	--	---	---

The following mounting method is recommended to use A surface matching clamp:

 <p>Use 4 clamps on the short side. Mounting rails run perpendicular to the long side frame. Overlapping length(perpendicular to the short side direction) of mounting rails and short side of module no less than 20 mm</p>	 <p>Use 4 clamps on the short side.</p>
---	---

DE09 DE09.05 DE09.08 DE09C.05 DE09C.07 DE09.05W DE09.08W	$A = (0 - 200)$ mm Uplift load ≤ 2000 Pa Downforce load ≤ 2400 Pa	DE09 DE09.05 DE09.08 DE09C.05 DE09C.07 DE09.05W DE09.08W	$A = (0 - 200)$ mm Uplift load ≤ 1800 Pa Downforce load ≤ 2400 Pa
--	---	--	---

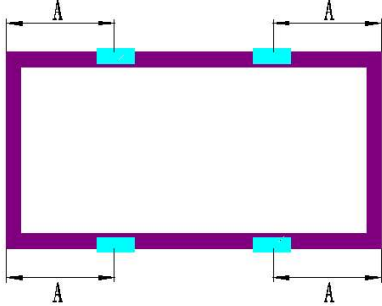
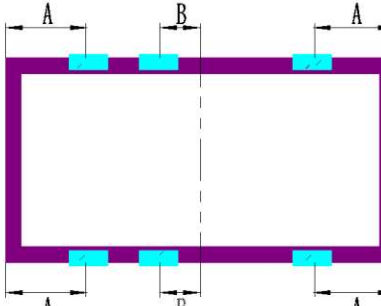
<p>NEG9.20 NEG9.28 NEG9C.27</p>	<p>A = (0 - 200) mm Uplift load ≤ 1600 Pa Downforce load ≤ 2100 Pa</p>	<p>DEG9R.20 DEG9R.28 DEG9RC.27 NEG9.20 NEG9.28 NEG9C.27 NEG9R.20 NEG9R.25 NEG9R.28 NEG9RC.20 NEG9RC.27 DEG9R.20W DEG9R.28W DEG9RC.27W</p>	<p>A = (0 - 100) mm Uplift load ≤ 1600 Pa Downforce load ≤ 2200 Pa</p>
<p>DE18M(II) DE18M.08(II) DE18M.W(II) DE18M.08W(II)</p>	<p>A = (0 - 200) mm Uplift load ≤ 1000 Pa Downforce load ≤ 1300 Pa</p>	<p>DE09R DE09R.05 DE09R.08 NE09RC.05 DE09R.W DE09R.05W DE09R.08W</p>	<p>A = (0 - 100) mm Uplift load ≤ 1800 Pa Downforce load ≤ 2400 Pa</p>
<p>/</p>	<p>/</p>	<p>DE18M(II) DE18M.08(II) DE18M.W(II) DE18M.08W(II)</p>	<p>A = (0 - 200) mm Uplift load ≤ 1000 Pa Downforce load ≤ 1300 Pa</p>
 <p>Use 4 clamps on the long side.</p>		 <p>Use 6 clamps on the long side.</p>	
<p>DE09 DE09.05 DE09.08 DE09C.05 DE09C.07 DE09.05W DE09.08W</p>	<p>A = (200 - 400) mm Uplift load ≤ 3000 Pa Downforce load ≤ 3600 Pa</p> <hr/> <p>A = (100 - 200 or 400 - 500) mm Uplift load ≤ 2000 Pa Downforce load ≤ 2400 Pa</p>	<p>DE09 DE09.05 DE09.08 DE09C.05 DE09C.07 DE09.05W DE09.08W DE09R.W DE09R.05W DE09R.08W NE09RC.05</p>	<p>A = (0 - 200) mm B = (0 - 200) mm Uplift load ≤ 2400 Pa Downforce load ≤ 3600 Pa</p>
<p>DE09R DE09R.05 DE09R.08 NE09RC.05 DE09R.W DE09R.05W DE09R.08W</p>	<p>A = (200 - 330) mm Uplift load ≤ 3000 Pa Downforce load ≤ 3600 Pa</p>		

DEG9R.20 DEG9R.28 DEG9RC.27 NEG9R.20 NEG9R.25 NEG9R.28 NEG9RC.20 NEG9RC.27 DEG9R.20W DEG9R.28W DEG9RC.27W	$A = (290 - 370) \text{ mm}$ Uplift load $\leq 2400 \text{ Pa}$ Downforce load $\leq 3000 \text{ Pa}$		
DE18M(II) DE18M.08(II) DE18M.W(II) DE18M.08W(II)	$A = (200 - 600) \text{ mm}$ Uplift load $\leq 1700 \text{ Pa}$ Downforce load $\leq 1700 \text{ Pa}$	DE18M(II) DE18M.08(II) DE18M.W(II) DE18M.08W(II)	$A = (0 - 200) \text{ mm}$ $B = (0 - 200) \text{ mm}$ Uplift load $\leq 1800 \text{ Pa}$ Downforce load $\leq 2400 \text{ Pa}$
DE19R	$A = (450 - 750) \text{ mm}$ Uplift load $\leq 1800 \text{ Pa}$ Downforce load $\leq 1100 \text{ Pa}$	/	/
<p>Use 4 clamps on the short side and 2 clamps on the long side.</p>		<p>Use 2 clamps on the short side and 2 clamps on the long side. Mounting rails run perpendicular to the long side frame.</p>	
DE09 DE09.05 DE09.08 DE09C.05 DE09C.07 DE09R DE09R.05 DE09R.08 DEG9R.20 DEG9R.28 DEG9RC.27 NE09RC.05 DE09.05W DE09.08W DE09R.W DE09R.05W DE09R.08W	$A = (0 - 200) \text{ mm}$ $B = (0 - 200) \text{ mm}$ Uplift load $\leq 2400 \text{ Pa}$ Downforce load $\leq 3000 \text{ Pa}$	DE09 DE09.05 DE09.08 DE09C.05 DE09C.07 DEG9R.20 DEG9R.28 DEG9RC.27 DE09.05W DE09.08W	$A = (250 - 450) \text{ mm}$ $B = (100 - 250) \text{ mm}$ Uplift load $\leq 1800 \text{ Pa}$ Downforce load $\leq 2400 \text{ Pa}$
DE18M(II) DE18M.08(II) DE18M.W(II) DE18M.08W(II)	$A = (0 - 200) \text{ mm}$ $B = (0 - 200) \text{ mm}$ Uplift load $\leq 1800 \text{ Pa}$ Downforce load $\leq 1800 \text{ Pa}$	DE18M(II) DE18M.08(II) DE18M.W(II) DE18M.08W(II)	$A = (250 - 450) \text{ mm}$ $B = (100 - 250) \text{ mm}$ Uplift load $\leq 1000 \text{ Pa}$ Downforce load $\leq 1200 \text{ Pa}$



Slide-in rails on the short side.

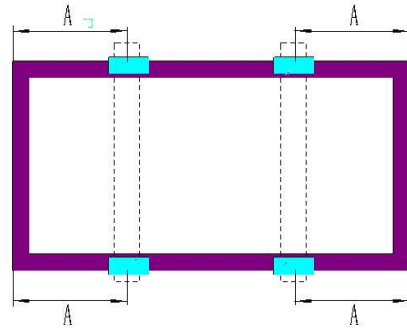

Use 4 clamps on the long side.
Mounting rails run perpendicular to the long side frame.

DE09 DE09.05 DE09.08 DE09C.05 DE09C.07 DE09.05W DE09.08W	Uplift load \leq 2000 Pa Downforce load \leq 2400 Pa	DE09 DE09.05 DE09.08 DE09C.05 DE09C.07 DE09.05W DE09.08W	A = (200 - 250 or 350 - 400) mm Uplift load \leq 3000 Pa Downforce load \leq 3600 Pa
NEG9R.20 NEG9R.25 NEG9R.28 NEG9RC.20 NEG9RC.27	Uplift load \leq 1600 Pa Downforce load \leq 2200 Pa	DE09.05W DE09.08W	A = (100 - 200 or 400 - 500) mm Uplift load \leq 2000 Pa Downforce load \leq 2400 Pa
DE18M(II) DE18M.08(II) DE18M.W(II) DE18M.08W(II)	Uplift load \leq 1000 Pa Downforce load \leq 1000 Pa	/	/



Use 4 clamps on the short side.
Mounting rails run parallel to the long side frame.

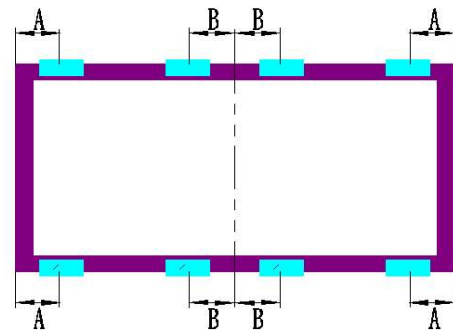

Use 8 clamps on the long side.

DE09 DE09.05 DE09.08 DE09C.05 DE09C.07 DE09.05W DE09.08W	A = (150 - 250) mm Uplift load \leq 2400 Pa Downforce load \leq 2400 Pa	DE09 DE09.05 DE09.08 DE09C.05 DE09C.07 DE09.05W DE09.08W	A = (0 - 200) mm B = (200 - 300) mm Uplift load \leq 2400 Pa Downforce load \leq 3600 Pa
DE18M(II) DE18M.08(II) DE18M.W(II) DE18M.08W(II)	A = (150 - 250) mm Uplift load \leq 1000 Pa Downforce load \leq 1600 Pa	DE18M(II) DE18M.08(II) DE18M.W(II) DE18M.08W(II)	A = (0 - 200) mm B = (250 - 350) mm Uplift load \leq 1800 Pa Downforce load \leq 2400 Pa
DE20 DE20.W	A = (45 - 485) mm Uplift load \leq 1000 Pa Downforce load \leq 3600 Pa	/	/

<p>Use 2 clamps on the short side and 2 clamps on the long side.</p>		/	/
DE20 DE20.W	<p>A = (1300 - 1450) mm B = (45 - 485) mm</p> <p>Uplift load \leq 1000 Pa Downforce load \leq 2400 Pa</p>		

6.2.3 SINGLE-AXIS INSTALLATION

The bolts used in this section is to secure the module in each fixing location with an M6/M8 bolt, two flat washers, a spring washer and a nut, and tighten them to a torque of 10-14 N.m, it is recommended to take regular inspection of the tightening to meet the torque range.

For all products covered in this section, all parts in contact with the frame should use flat stainless steel washers of minimum 1.5 mm (0.06 inch) thickness with an outer diameter of 16-18 mm (0.63-0.71 inch).

When using reinforced attachment I*, all accessories should be mounted together onto the torque and the accessory bolts should be tightened using wrench tools, the attachment I* should be installed in the center of the module. it shall be installed as closer as possible to the center junction box if there is a junction box in the center of the module, do not contact the junction box to avoid stress.

The module has to be installed on the purlins.

Module type	Mechanical loads	Module type	Mechanical loads
<p>Mounting rails run perpendicular to the long side frame. Distance between mounting holes is 400 mm/790mm/1400mm.</p>		<p>This installation method is for the tracker with reinforced attachment I* only. Mounting rails run perpendicular to the long side frame. Distance between mounting holes is 400 mm.</p>	
DEG18MC.20(II) DEG18MC.20W(II)	<p>Distance between mounting holes is 400mm Uplift load \leq 2400 Pa Downforce load \leq 2400 Pa</p>	DEG19C.20 DEG19RC.20 NEG19C.20 NEG19RC.20 DEG19C.20W DEG19RC.20W	<p>Uplift load \leq 2400 Pa Downforce load \leq 2400 Pa</p>

DEG20C.20 DEG21C.20 NEG20C.20 NEG21C.20 DEG20C.20W DEG21C.20W	Distance between mounting holes is 400mm Uplift load \leq 2200 Pa Downforce load \leq 2200 Pa	/	/
DEG20C.20 DEG21C.20 NEG20C.20 NEG21C.20 DEG20C.20W DEG21C.20W	Distance between mounting holes is 790mm Uplift load \leq 2500 Pa Downforce load \leq 2800 Pa		
DEG19C.20 DEG19RC.20 NEG19C.20 NEG19RC.20 DEG19C.20W DEG19RC.20W	Distance between mounting holes is 790mm Uplift load \leq 2600 Pa Downforce load \leq 3000 Pa		
DEG20C.20 DEG21C.20 NEG20C.20 NEG21C.20 DEG20C.20W DEG21C.20W	Distance between mounting holes is 1400mm Uplift load \leq 2600 Pa Downforce load \leq 3000 Pa		

**Reinforced attachment I: bumper*

All the mechanical loads above have been approved by PVST. Please consult Trina Solar customer service for compatibility of tracker system with Trina products.

6.3 GROUNDING

All module frames and mounting racks must be properly grounded in accordance with the electrical design and construction specifications, procedures, regulations and other special grounding requirements applicable to the installation sites.

Proper grounding can be achieved by connecting the module frame(s) and all metallic structural components together by using a suitable grounding conductor. The grounding conductors or wires may be copper, alloy, or any other materials that are in accordance with the local electrical design and construction specifications, procedures, and regulations. The ground conductor must be reliably grounded by a suitable ground electrode.

General grounding hardware comes in a package that includes the grounding screw, flat washer, star washer and wire and other relevant hardware should be made of stainless steel.

Do not drill any extra ground holes for convenience, this will void the modules warranty.

Trina Solar does not provide grounding devices or materials. Any third-party grounding device that meets the requirements of the installation electrical equipment specifications can be used for grounding of Trina Solar’s modules. The grounding device should be installed in accordance with the operating manual prescribed by the manufacturer.

Trina Solar recommends using grounding wires with resistances that are less than 1Ω.

The electrical contact is made by penetrating the anodized coating of the aluminum frame, and tightening the mounting screw (together with the star washer) to the proper torque of 3-7 N.m.

Grounding connections should be installed by a qualified electrician. Connect module frames together using adequate grounding cables: Grounding wire size (4-16 mm²/12-6 AWG solid bare copper) should be selected and installed underneath the wire binding bolt. Holes provided for this purpose are identified with a grounding symbol (IEC61730-1). All conductive connection junctions must be firmly fixed.

To avoid lightning strikes and ensure electrical safety, the module frames must be reliably grounded. Grounding between modules can be done using a 4 mm² (12 AWG) solid bare copper that connects adjacent ground holes on the module frame (unused installation holes on the frame can also be used for grounding).

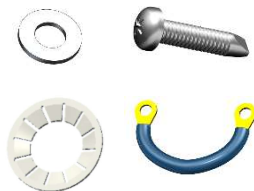
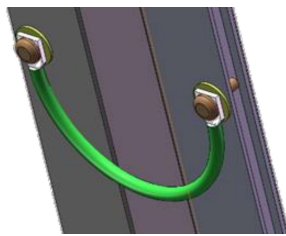
Components	View	Connection
		<p>Star washer, flat washer, grounding wire are placed in turn, then screwed into the grounding hole to bond the adjacent modules</p>

Trina Solar recommends using the following two methods for grounding installation, as shown in Figure 4.

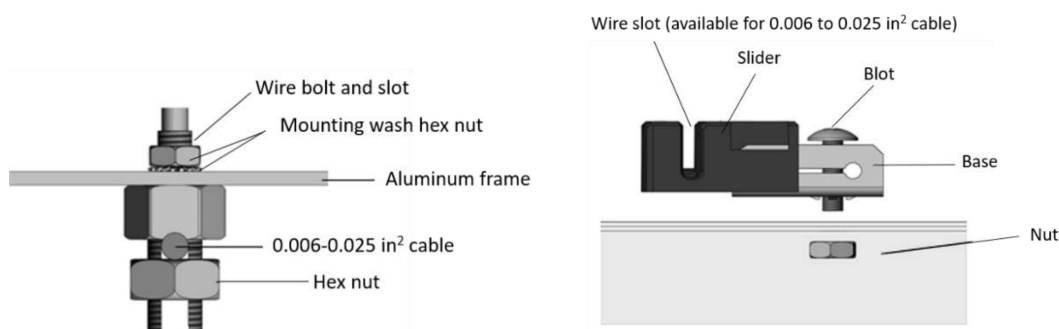

Figure 4. PV module grounding methods (IEC standard).

6.4 ELECTRICAL INSTALLATION

6.4.1 SAFETY INSTRUCTION

All wiring installation should be carried out by qualified installers in accordance with local electrical construction codes, procedures, and regulations.

Modules can be connected in series to increase the operating voltage by connecting the positive terminal of one module into the negative terminal of the next one. Before connecting, always ensure that the contacts are corrosion-free, clean, and dry.

The product can be irreparably damaged if an array string is connected in reverse polarity to another. Always verify the voltage and polarity of each string before making a parallel connection. If a reversed polarity or a difference of more than 10V between strings was detected, check the string configuration before connection.

The standard copper cables applied in Trina Solar modules are UV resistant and with a cross-sectional area of $\geq 4 \text{ mm}^2$ (12 AWG). All other cables applied to connect the DC system should be provided with a similar or larger wire cross section. Trina Solar recommends that all cables are routed in appropriate conduits or rails where water does not accumulate.

The string voltage must not be higher than the maximum system voltage, as well as the maximum input voltage of the inverter and the other electrical devices installed in the system. In order to ensure this, the open circuit voltage of an array needs to be calculated at the lowest expected local ambient temperature, which can be determined using the following formula:

$$\text{Max System Voltage} \geq N \times V_{oc} \times [1 + TC_{VOC} \times (T_{min} - 25)] \text{ where}$$

- N Number of modules in series
- V_{oc} Open circuit voltage (refer to product label or data sheet)
- TC_{VOC} Temperature coefficient of open circuit voltage (refer to data sheet)
- T_{min} The minimum ambient temperature

The number of modules that can be connected shall be determined by a qualified institution or person in accordance with the design specifications of the photovoltaic system and the local electrical design specifications. The calculation formula recommended by Trina Solar shall be for reference only.

Recommended maximum series is $[1500V / (1.25 * V_{oc})]$, parallel module configurations is $[fuse\ rating / I_{sc} * 1.25]$.

Every module is provided with two standard output cables, and each terminated with a plug-and-play connector. All wiring and electrical connections must be installed in accordance with the electrical design and construction specifications, procedures and regulations at the place of installation.

The minimum and maximum outer diameters of the cable are 5 to 7 mm (0.20 to 0.28 in).

For wiring connections, please use standard PV copper wires with a cross-section area of at least 4 mm² (12 AWG), and should be light-resistant and temperature-resistant at a minimum of 90 °C.

When installing modules flat on the roof, it is recommended to use 4-6 mm² PV-specific cables.



Do not bend the cables less than 43 mm (1.69 inch) radius. PV cables will be damaged if bending radius less than 43 mm.

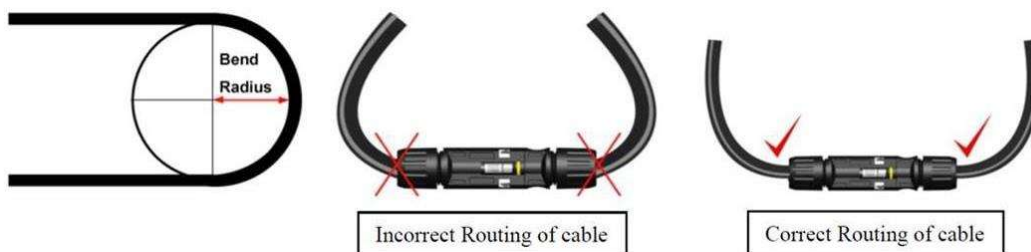

Figure 5. The correct routing and minimum bending radius of cables.

6.4.2 WIRING

In order to ensure the normal operation of the system, when connecting the module or loads (such as inverters, batteries, etc.), observe to ensure that the polarity of the cable is connected correctly. If modules are not connected correctly, the bypass diode could be damaged. PV modules can be connected in series to increase the voltage and connected in parallel to increase the current, as shown in Figure 6.

Before connecting the module, please make sure using the connector approved by Trina. Otherwise, Trina does not responsible for any potential problem.

When conducting electrical connection of the modules, please use diagonal pliers to cut the cable tie. When cutting the tie, be careful not to scratch the cable and backsheet. According to the electrical requirements. The positive and negative connectors should be connected in turn, and confirm that you hear a "click" to indicate that the connection is successful. Otherwise, during the operation of the modules, this could lead to electric arc due to poor connections and can burn the connectors.



Field-assembled Trina connectors have to be subject to the terms and requirements of Connector Installation Manual PS-M-0779 and Warranty PS-M-0611.

Before the commissioning and operation of the power station, please check the electrical connection of modules and strings, making sure all connection polarity is correct and the open circuit voltage meets the requirements of the acceptance criteria.

The number of modules in series and in parallel shall be designed reasonably according to the system configuration.

All the above instructions must be followed to meet Trina Solar's warranty conditions.

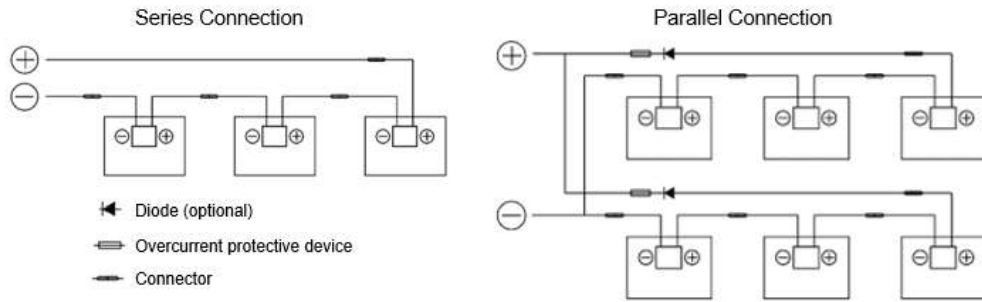
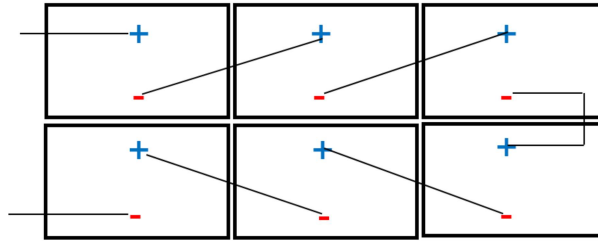

Figure 6. Series and parallel connection circuit diagram.

Trina Solar recommends the following two wiring methods for portrait and landscape installations with short and long cable lengths, respectively. For specific standard cable lengths, please refer to the datasheets of the products.

Recommended Wiring Methods	Graphical View
Portrait installation: Standard short cable length	<p style="text-align: center;">(C-type Wiring)</p> <p style="text-align: center;">(Note: One end of the single row needs to be extended)</p>
Portrait installation: Standard short cable length	<p style="text-align: center;">(Linear Wiring)</p> <p style="text-align: center;">(Note: One end of the single row needs to be extended)</p>

Landscape installation:
Standard long cable length or
customized length



6.4.3 FUSING

The correction factor of a fuse shall be determined by an authorized professional electrical engineer in accordance with the relevant design regulations and system simulation results. Trina Solar does not responsible for determining the minimum rating of fuse.

The fuse rated current should be chosen depending on different standards, as follows:

$$\frac{1.5}{K_f} \cdot I_{SC} \leq I_n \leq \text{Max Series Fuse Rating (IEC standard)}$$

$$\frac{1.56}{K_f} \cdot I_{SC} \leq I_n \leq \text{Max Series Fuse Rating (NEC standard)}$$

where

- I_n Fuse rated current [A]
- I_{SC} Short circuit current of the module [A]
- K_f Temperature correction factor [-]

A correction factor (K_f) should be applied for determining the fuse rated current working at different temperatures. Please confirm the final fuse selection with the qualified design institutes and fuse manufacturer. The maximum series fuse rating value on the products' datasheet provided by Trina Solar should be used for reference only. Modules equipped with PV Bypass diode that comply with the Standard for Bypass diode for Use in Photovoltaic Systems, shall have the specific allowable mating bypass diode manufacturer(s) and model number(s) listed in Appendix 3.

7 PV MODULE MAINTENANCE

7.1 VISUAL INSPECTION AND REPLACEMENT

The modules must be inspected and maintained regularly, which is the responsibility of the users. The circuit breaker should be disconnected before the inspection, and any broken or damaged modules are prohibited from further use. Broken glass, broken cables and damaged junction boxes may cause functional and safety failures. If the module is damaged, replace the damaged module with a new module of the same type. Do not touch the live part of the cable or connector.

It is recommended to perform a preventive inspection every six months, and do not replace components of modules without authorization. If electrical or mechanical performance inspection or maintenance is required, it is recommended that qualified professionals should perform the operation to avoid electric shock or personal injury. After extreme weather conditions (hail, strong winds, tornadoes, thunderstorms, tropical cyclones, etc.), inspections must be carried out in a timely manner.

The vegetation should be cut regularly to avoid shading and thus affecting the module's performance.

Check if the mounting hardware is tightened correctly in place.

Check whether all string fuses in each non-grounded pole are working properly.

Please cover the front surface of modules with an opaque material during repairing. Modules exposed to sunlight can generate high voltage, which is extremely dangerous.

Trina Solar PV modules are equipped with bypass diodes in the junction box to minimize module heating and current losses.



Before cleaning, make sure to wear PPE, such as insulated protective gloves, protective glasses, hard hats, safety insulated shoes, etc.

When using scaffolding, make sure that the scaffolding is in a stable position or with anti-dumping measures, and that the installer should wear a safety belt in accordance with local building codes.

Do not stand on the modules or trackers for cleaning work.

Do not try to open the junction box to change the diodes even if they fail.

If the module is damaged (broken glass or scratches on the back sheet), it needs to be replaced.

It is necessary to wear cut-resistant gloves and other personal protective equipment for special installations.

Make sure to isolate the impacted array string to prevent the current generation before attempting to remove the module.

Use the relevant disconnect tool provided by the supplier to disconnect the connector of the affected module.

Check the open circuit voltage of the array string and verify that the open circuit voltage of other strings connected in parallel are within a range of 10V difference.

Turn the circuit breaker on again after checking.

Please also pay attention to other safety precautions listed at the beginning of this manual.

7.2 CONNECTOR AND CABLE INSPECTION

The following preventive maintenance checks are recommended to be performed every 6 months:

Check the sealant of the junction box to ensure there are no cracks or gaps.

Check all connectors for tight connections and corrosion; check all aspects of connectors, bolt torque, and grounding; check that mounted hardware is tightened in place, loose connections will cause damage to array.

Check all cables for rodent damage or material deterioration to verify the connections. In addition, protect cables from direct sunlight and water immersion.

7.3 CLEANING

This manual covers the requirements for the cleaning procedures of Trina Solar PV modules. Professional installers should read these guidelines carefully and strictly follow these instructions. Failure to follow these instructions may result in death, injury, or property damage. Damages induced by inappropriate cleaning procedures will void Trina Solar warranty.

The amount of electricity generated by a solar module is proportional to the amount of light captured. A module with shaded cells generate less energy, and therefore, it is essential to keep PV modules clean. The dirt such as bird droppings, leaves, dust is usually need to be cleaned.

When cleaning the modules, make sure that the temperature difference between the water and the module is in the range of -5°C to 10°C .

Use a dry or wet, soft and clean cloth, sponge, or soft bristled brush to wipe the photovoltaic module. Please make sure that the cleaning tools do not wear out glass, EPDM, silicon, aluminum alloys or steel.

If there is greasy dirt or other substances which are difficult to clean, conventional household glass cleaning agents can be used. Pay attention not to use alkaline and strong acidic solvents, including hydrofluoric acid, alkali, acetone.

For modules that are installed horizontally (0° tilt angle), they should be cleaned more frequently, as they do not have "self-cleaning" function as those installed at 10° or larger tilt angles.

The back surface of the monofacial module usually does not need to be cleaned. When cleaning the back of the bifacial module, avoid any sharp objects that may cause damage or penetrate the base material. The other cleaning requirements are the same as the front-side.

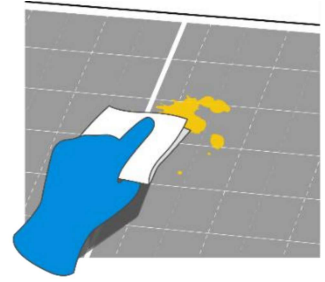

Cleaning activities create risk of damaging the modules and array components, as well as increasing the potential electric shock hazard.

Do not clean the modules during the hottest time of the day to avoid thermal stress on the modules.

Cracked or broken modules represent an electric shock hazard due to leakage currents, and the risk of shock is increased when modules are wet. Before cleaning, thoroughly inspect modules for cracks, damage, and loose connections.

During the daylight, the voltage and current present in the array are sufficient to cause a fatal electric shock.

Please make sure that the array has been disconnected from other active components before starting the cleaning.

Wear suitable protective clothing (clothes, insulating gloves, etc.) when cleaning the modules.

Do not immerse the module, partially or totally, in water or any other cleaning solutions.

Do not use such as lubricants and organic solvents to clean the connectors.

Do not clean modules under the weather conditions of wind more than 4 class (in Beaufort scale), heavy rain or heavy snow.

When cleaning the modules, it is forbidden to step on the modules, forbidden the injection of water to the backside of the modules or cables. Please ensure that the connectors are clean and dry to prevent electric shock and fire hazards.

Do not use steam cleaner.

For detailed requirements regarding cleaning, please refer to *White Paper for PV Modules Operation and Maintenance*, available from <https://www.trinasolar.com/en-gb/resources/downloads>. **CLEANING METHODS**

Method A: Compressed water

Requirement for water quality:

- PH: 6~8;
- Water hardness-Calcium carbonate concentration : ≤600 mg/L
- Recommend to use soft water to wash.
- The recommended maximum water pressure is 4 MPa (40 bar)

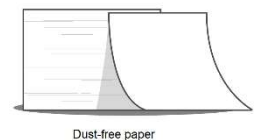
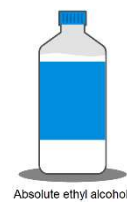

Method B: Compressed Air

Trina Solar recommends using this method to clean the soft dirt (like dust) on modules. This technique can be applied as long as the method is efficient enough to clean the modules considering the on-site conditions.

Method C: Wet cleaning

If excessive soiling is present on the module surface, a non-conductive brush, sponge, or other mild agitating method may be used with caution.

Please make sure that any brushes or agitating tools are constructed with non-conductive materials to minimize risk of electric shock and that they are not abrasive to the glass or the aluminum frame.

If grease is present, an environmentally friendly cleaning agent may be used with caution.

Method D: Cleaning robot

If a cleaning robot is used for dry cleaning, the brush material is required to be soft plastic material, and the glass surface and aluminum alloy frame of the module will not be scratched during the cleaning process and after cleaning. The weight of the cleaning robot should not be too large. If the cleaning robot is improperly used, and the resulting module damage and power attenuation are not covered by Trina Solar's warranty.

7.4 WEEDING

This manual contains recommendations for weeding operation and maintenance of photovoltaic power station. The following measures can be taken to a certain extent to avoid and prevent the problem of module damage caused by stone splashing during weeding. System users and professional operation and maintenance personnel should read carefully. Trina Solar warranty will be invalid if the module or glass is damaged by any external force.

When the height of vegetation does not affect the normal operation and maintenance of the module, weeding can not be carried out.

The use of scythe manually instead of weeding machine weeding, or the use of professional weeding equipment with protective devices can reduce the probability of stone splash to a certain extent.

TROUBLE SHOOTING

If your PV system does not work normally after installation, please inform your installer immediately. It is recommended to perform preventive inspections every six months, and do not change the components of the modules without authorization. If electrical or mechanical performance inspection or maintenance is required, they should be operated by qualified professionals to avoid any electric shock or personal injury.

8 REPORTING TECHNICAL ISSUES AND CLAIMS

- Contact your installer.
- Contact Trina Solar after sales service team at <http://customerservice.trinasolar.com/>.
- Submit the Customer Feedback Form at: <http://customerservice.trinasolar.com/> and one of our technical service representatives will contact you within 5 business days. A username and password is required to send feedback from the customer service link.
- For module specifications or datasheets, please download from: <http://www.trinasolar.com/>.

AMENDED EDITIONS AND DATES

- Document No. UM-M-0002, Version A, released in April 2021.
- Document No. UM-M-0002, Version B, released in June 2021.
- Document No. UM-M-0002, Version C, released in August 2021.
- Document No. UM-M-0002, Version D, released in December 2021.
- Document No. UM-M-0002, Version E, released in March 2022.
- Document No. UM-M-0002, Version F, released in April 2022.
- Document No. UM-M-0002, Version G, released in October 2022.
- Document No. UM-M-0002, Version H, released in December 2022.
- Document No. UM-M-0002, Version I, released in Jun 2023.
- Document No. UM-M-0002, Version J, released in Nov 2023.
- Document No. UM-M-0002, Version K, released in April 2024.
- Document No. UM-M-0002, Version L, released in August 2024.



天合光能股份有限公司

江苏省常州市新北区天合光伏园·天合路 2 号

Trina Solar Co., Ltd.

2 Tianhe Road, Tianhe Photovoltaic Industrial Park, Xinbei District

Changzhou City, Jiangsu Province, China.



4006890000

解释权归天合光能股份有限公司所有

The Right Of Final Interpretation Belongs To Trina Solar